



Video Intercom Indoor Station

User Manual

User Manual

©2018 Hangzhou Hikvision Digital Technology Co., Ltd.

This user manual is intended for users of the models below:

Series	Model
Indoor Station (6-Series)	DS-KH6310-W
	DS-KH6310
	DS-KH6310-WL
	DS-KH6210-L
Indoor Station (8-Series)	DS-KH8301-WT
	DS-KH8300-T

It includes instructions on how to use the Product. The software embodied in the Product is governed by the user license agreement covering that Product.

About this Manual

This Manual is subject to domestic and international copyright protection. Hangzhou Hikvision Digital Technology Co., Ltd. (“Hikvision”) reserves all rights to this manual. This manual cannot be reproduced, changed, translated, or distributed, partially or wholly, by any means, without the prior written permission of Hikvision.

Trademarks

HIKVISION and other Hikvision marks are the property of Hikvision and are registered trademarks or the subject of applications for the same by Hikvision and/or its affiliates. Other trademarks mentioned in this manual are the properties of their respective owners. No right of license is given to use such trademarks without express permission.

Disclaimer

TO THE MAXIMUM EXTENT PERMITTED BY APPLICABLE LAW, HIKVISION MAKES NO WARRANTIES, EXPRESS OR IMPLIED, INCLUDING WITHOUT LIMITATION THE IMPLIED WARRANTIES OF MERCHANTABILITY AND FITNESS FOR A PARTICULAR PURPOSE, REGARDING THIS MANUAL. HIKVISION DOES NOT WARRANT, GUARANTEE, OR MAKE ANY REPRESENTATIONS REGARDING THE USE OF THE MANUAL, OR THE CORRECTNESS, ACCURACY, OR RELIABILITY OF INFORMATION CONTAINED HEREIN. YOUR USE OF THIS MANUAL AND ANY RELIANCE ON THIS MANUAL SHALL BE WHOLLY AT YOUR OWN RISK AND RESPONSIBILITY.

TO THE MAXIMUM EXTENT PERMITTED BY APPLICABLE LAW, IN NO EVENT WILL HIKVISION, ITS DIRECTORS, OFFICERS, EMPLOYEES, OR AGENTS BE LIABLE TO YOU FOR ANY SPECIAL, CONSEQUENTIAL, INCIDENTAL, OR INDIRECT DAMAGES, INCLUDING, AMONG OTHERS, DAMAGES FOR LOSS OF BUSINESS PROFITS, BUSINESS INTERRUPTION, SECURITY BREACHES, OR LOSS OF DATA OR DOCUMENTATION, IN CONNECTION WITH THE USE OF OR RELIANCE ON THIS MANUAL, EVEN IF HIKVISION HAS BEEN ADVISED OF THE POSSIBILITY OF SUCH DAMAGES.

SOME JURISDICTIONS DO NOT ALLOW THE EXCLUSION OR LIMITATION OF LIABILITY OR CERTAIN DAMAGES, SO SOME OR ALL OF THE ABOVE EXCLUSIONS OR LIMITATIONS MAY NOT APPLY TO YOU.

Support

Should you have any questions, please do not hesitate to contact your local dealer.

Regulatory Information

FCC Information

Please take attention that changes or modification not expressly approved by the party responsible for compliance could void the user's authority to operate the equipment.

FCC compliance: This equipment has been tested and found to comply with the limits for a Class A digital device, pursuant to part 15 of the FCC Rules. These limits are designed to provide reasonable protection against harmful interference when the equipment is operated in a commercial environment. This equipment generates, uses, and can radiate radio frequency energy and, if not installed and used in accordance with the instruction manual, may cause harmful interference to radio communications. Operation of this equipment in a residential area is likely to cause harmful interference in which case the user will be required to correct the interference at his own expense.

FCC Conditions

This device complies with part 15 of the FCC Rules. Operation is subject to the following two conditions:

1. This device may not cause harmful interference.
2. This device must accept any interference received, including interference that may cause undesired operation.

EU Conformity Statement



This product and - if applicable - the supplied accessories too are marked with "CE" and comply therefore with the applicable harmonized European standards listed under the EMC Directive 2014/30/EU, the RoHS Directive 2011/65/EU.



2012/19/EU (WEEE directive): Products marked with this symbol cannot be disposed of as unsorted municipal waste in the European Union. For proper recycling, return this product to your local supplier upon the purchase of equivalent new equipment, or dispose of it at designated collection points. For more information see: www.recyclethis.info



2006/66/EC (battery directive): This product contains a battery that cannot be disposed of as unsorted municipal waste in the European Union. See the product documentation for specific battery information. The battery is marked with this symbol, which may include lettering to indicate cadmium (Cd), lead (Pb), or mercury (Hg). For proper recycling, return the battery to your supplier or to a designated collection point. For more information see: www.recyclethis.info

Industry Canada ICES-003 Compliance

This device meets the CAN ICES-3 (A)/NMB-3(A) standards requirements.



Safety Instruction

These instructions are intended to ensure that user can use the product correctly to avoid danger or property loss.

The precaution measure is divided into **Warnings** and **Cautions**:

Warnings: Neglecting any of the warnings may cause serious injury or death.

Cautions: Neglecting any of the cautions may cause injury or equipment damage.

	
Warnings Follow these safeguards to prevent serious injury or death.	Cautions Follow these precautions to prevent potential injury or material damage.



Warnings

- The working temperature of the device is from -10° C to 55° C.
- All the electronic operation should be strictly compliance with the electrical safety regulations, fire prevention regulations and other related regulations in your local region.
- Please use the power adapter, which is provided by normal company. The power consumption cannot be less than the required value.
- Do not connect several devices to one power adapter as adapter overload may cause over-heat or fire hazard.
- Please make sure that the power has been disconnected before you wire, install or dismantle the device.
- When the product is installed on wall or ceiling, the device shall be firmly fixed.
- If smoke, odors or noise rise from the device, turn off the power at once and unplug the power cable, and then please contact the service center.
- If the product does not work properly, please contact your dealer or the nearest service center. Never attempt to disassemble the device yourself. (We shall not assume any responsibility for problems caused by unauthorized repair or maintenance.)



Cautions

- Do not drop the device or subject it to physical shock, and do not expose it to high electromagnetism radiation. Avoid the equipment installation on vibrations surface or places subject to shock (ignorance can cause equipment damage).
- Do not place the device in extremely hot (refer to the specification of the device for the detailed operating temperature), cold, dusty or damp locations, and do not expose it to high electromagnetic radiation.
- The device cover for indoor use shall be kept from rain and moisture.

- Exposing the equipment to direct sun light, low ventilation or heat source such as heater or radiator is forbidden (ignorance can cause fire danger).
- Do not aim the device at the sun or extra bright places. A blooming or smear may occur otherwise (which is not a malfunction however), and affecting the endurance of sensor at the same time.
- Please use the provided glove when open up the device cover, avoid direct contact with the device cover, because the acidic sweat of the fingers may erode the surface coating of the device cover.
- Please use a soft and dry cloth when clean inside and outside surfaces of the device cover, do not use alkaline detergents.
- Please keep all wrappers after unpack them for future use. In case of any failure occurred, you need to return the device to the factory with the original wrapper. Transportation without the original wrapper may result in damage on the device and lead to additional costs.
- Improper use or replacement of the battery may result in hazard of explosion. Replace with the same or equivalent type only. Dispose of used batteries according to the instructions provided by the battery manufacturer.

Table of Contents

1 Overview	1
1.1 Introduction	1
1.2 Main Features	1
2 Appearance	2
2.1 Appearance of DS-KH8301-WT/ DS-KH8300-T	2
2.2 Appearance of DS-KH6310-W/DS-KH6310	3
2.3 Appearance of DS-KH6310-WL/DS-KH6210-L	4
3 Typical Application	6
4 Terminals and Wiring	7
4.1 Terminal Description	7
4.1.1 Terminals and Interfaces of DS-KH8301-WT/DS-KH8300-T	7
4.1.2 Terminals and Interfaces of DS-KH6310-W/ DS-KH6310	8
4.1.3 Terminals and Interfaces of DS-KH6310-WL/ DS-KH6210-L	9
4.2 Wiring Description	9
4.2.1 Wiring of DS-KH8301-WT/DS-KH8300-T	9
4.2.2 Wiring of DS-KH6310-W/DS-KH6310	10
4.2.3 Wiring of DS-KH6310-WL/DS-KH6210-L	11
5 Installation	12
5.1 Installation Accessory Description	12
5.2 Wall Mounting with Gang Box	12
6 Local Operation	14
6.1 Activate Device Locally	14
6.2 User Interface Description	15
6.2.1 User Interface of Indoor Station	15
6.2.2 User Interface of Indoor Extension	16
6.2.3 Status of Indoor Station	16
6.2.4 Status of Indoor Extension	17
6.2.5 Arming Status	18
6.3 Configuration Settings	20
6.3.1 Set Indoor Station Network	20
6.3.2 Set SIP Sever	21
6.3.3 Set Linked Device IP	25
6.3.4 Set Indoor Station No.	26
6.3.5 Add Camera	27
6.3.6 Synchronize Time	28
6.3.7 Restore Indoor Station	29
6.4 Password Settings	29

6.5 Sound Settings	31
6.6 Do Not Disturb Settings	32
6.7 Zone Settings	33
6.8 Arming Mode Settings	34
6.9 System Maintenance	35
6.10 Call Settings	36
6.10.1 Add Contact	36
6.10.2 Call Resident	37
6.10.3 Call Indoor Extension/Indoor Station	38
6.10.4 Call Center	38
6.10.5 Receive Call	38
6.10.6 View Call Logs	40
6.11 Live View	41
6.12 Information Management	42
7 Remote Operation via Batch Configuration Tool	44
7.1 Activate Device Remotely	44
7.2 Edit Network Parameters	45
7.3 Add Device	46
7.3.1 Add Online Device	46
7.3.2 Add by IP Address	47
7.3.3 Add by IP Segment	48
7.4 Configure Devices Remotely	49
7.4.1 System	49
7.4.2 Video Intercom	54
7.4.3 Network	60
7.4.4 Video Display	62
7.5 Video Intercom Device Set-up Tool	62
7.5.1 Set a Community Structure	62
7.5.2 Set Indoor Station	63
7.6 Batch Upgrading	65
7.6.1 Add Devices for Upgrading	65
7.6.2 Upgrade by File	67
8 Remote Operation via iVMS-4200	69
8.1 System Configuration	69
8.2 Device Management	70
8.2.1 Add Video Intercom Devices	70
8.2.2 Modify Network Information	72
8.2.3 Reset Password	73
8.3 Remote Configuration	75
8.4 Person and Card Management	75
8.4.1 Organization Management	77
8.4.2 Person Management	78
8.5 Video Intercom	84
8.5.1 Call Indoor Station via iVMS-4200	85
8.5.2 Receive Call from Indoor Station/Door Station	86

8.5.3 View Live Video of Door Station and Outer Door Station	88
8.5.4 View Call Logs	89
8.5.5 Release Notice.....	89
8.5.6 Search Video Intercom Information	92
9 Accessing via Hik-Connect Mobile Client Software	96
9.1 Install Software	96
9.1.1 Install Software (iOS)	96
9.1.2 Install Software (Android)	96
9.2 Register Software.....	96
9.3 Log in Software	98
9.4 Add Device	98
9.4.1 Add Device via QR Code	99
9.4.2 Add Device via Serial No.....	100
9.5 Live View and Remote Unlocking	101
Appendix	102
Installation Notice	102
Wiring Cables	102

1 Overview

1.1 Introduction

The video intercom system can realize functions such as video intercom, resident-to-resident video call, live view of HD video, access control, one-card system, elevator linkage, zone alarm, notice information and visitor messages to provide a complete smart community video intercom system.

The video intercom indoor station is mainly applied to situations such as community, villa, and official buildings.

1.2 Main Features

- Video intercom function
- Remote unlocking function
- Resident-to-resident audio call
- Live view of HD video
- Voice message function
- Auto-respond and no disturbing mode
- Noise suppression and echo cancellation
- Zone alarm and SOS calling function
- Community notice
- Convenient installation with the bracket, batch settings, and power over video/audio distributor (DS-KAD606, DS-KAD612)

2 Appearance

2.1 Appearance of DS-KH8301-WT/ DS-KH8300-T

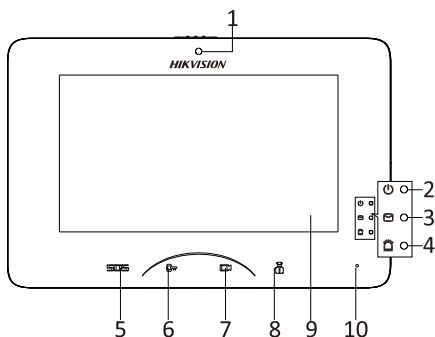

Table 2-1 Components Description

No.	Description
1	Built-in Camera (Only DS-KH8301-WT supports)
2	Power Supply Indicator
3	Information Indicator
4	Alarm Indicator
5	SOS Touch Key
6	Unlock Touch Key
7	Live View Touch Key
8	Management Center Touch Key
9	LCD Display Screen
10	Microphone

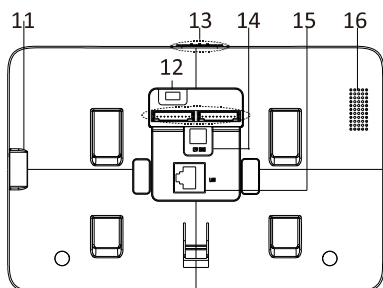



Table 2-2 Components Description

No.	Description
11	TF Card Slot
12	Serial Port
13	Mechanical Switch
14	Power Supply Indicator
15	Network Interface
16	Loudspeaker



NOTE

- Hold **SOS** to trigger a SOS alarm and upload the alarm message to the management center (iVMS-4200 client software or the master station).
- The Unlock key () is valid only when does the indoor station speak with the door station or open the live view of the door station.

2.2 Appearance of DS-KH6310-W/DS-KH6310

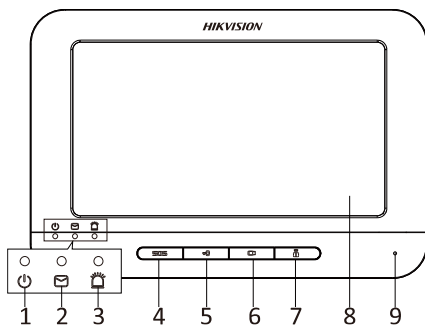

Table 2-3 Components Description

No.	Description
1	Power Supply Indicator
2	Information Indicator
3	Alarm Indicator
4	SOS Key
5	Unlock Key
6	Live View Key
7	Management Center Key
8	LCD Display Screen
9	Microphone

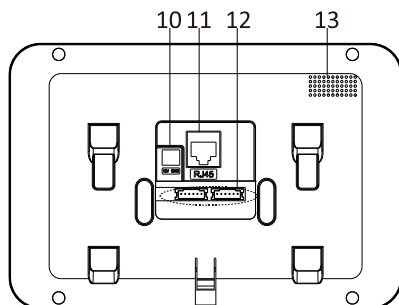



Table 2-4 Components Description

No.	Description
10	Power Supply Interface
11	Network Interface
12	Terminals
13	Loudspeaker



NOTE

- Hold **SOS** to trigger a SOS alarm and upload the alarm message to the management center (iVMS-4200 client software or the master station).
- The Unlock key () is valid only when does the indoor station speak with the door station or open the live view of the door station.

2.3 Appearance of DS-KH6310-WL/DS-KH6210-L

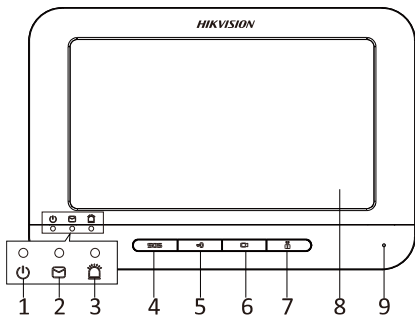

Table 2-5 Components Description

No.	Description
1	Power Supply Indicator
2	Information Indicator
3	Alarm Indicator
4	SOS Key
5	Unlock Key
6	Live View Key
7	Management Center Key
8	LCD Display Screen
9	Microphone

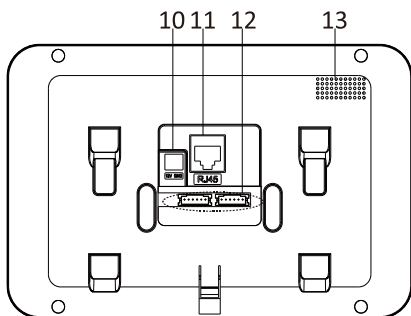







Table 2-6 Components Description

No.	Description
10	Power Supply
11	Network Interface
12	Terminals
13	Loudspeaker



NOTE

- Hold **SOS** to trigger a SOS alarm and upload the alarm message to the management center (iVMS-4200 client software or the master station).
- The Unlock key () is valid only when does the indoor station speak with the door station or open the live view of the door station.
- For DS-KH6210-L indoor station, there are different meanings when you press or hold the four mechanical keys.

Keys	Hold	Press
	SOS Key	Return Key
		Direction Keys ▲ and ◀/Unlock Key
	Live View Key Alarm	Direction Keys ▼ and ▶
	Management Center Key	Confirm Key

3 Typical Application

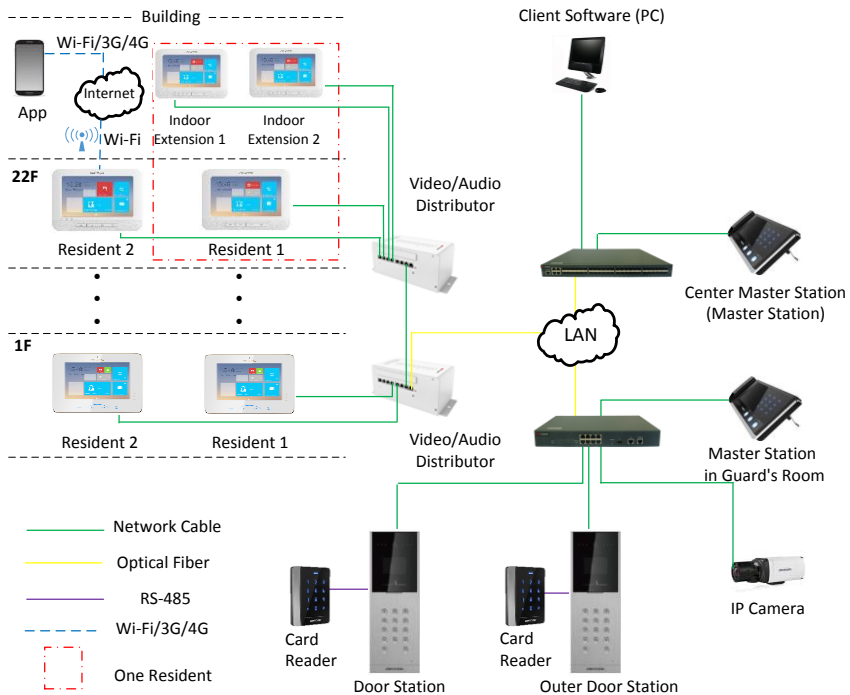

4 Terminals and Wiring

4.1 Terminal Description

4.1.1 Terminals and Interfaces of DS-KH8301-WT/DS-KH8300-T

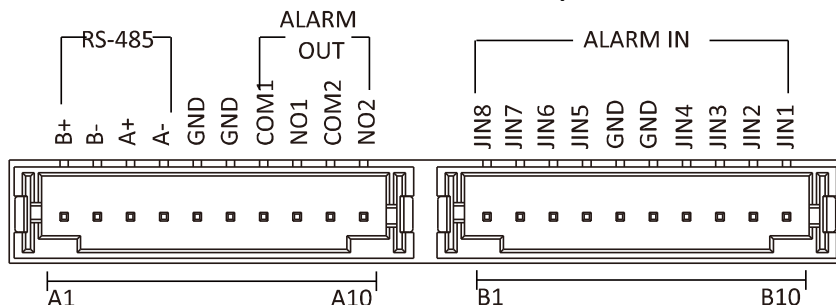

Table 4-1 Descriptions of Terminals and Interfaces

Name	No.	Interface	Description
485 Communication Port	A1	RS485B+	Reserved
	A2	RS485B-	
	A3	RS485A+	
	A4	RS485A-	
Grounding	A5	GND	Grounding
	A6	GND	Grounding
ALARM OUT (Alarm Output)	A7	COM1	Alarm Relay Output Terminal 1 (Dry Contact)
	A8	NO1	
	A9	COM2	Alarm Relay Output Terminal 2 (Dry Contact)
	A10	NO2	
ALARM IN (Zone Input)	B1	JIN8	Zone Detector Input Terminal 8
	B2	JIN7	Zone Detector Input Terminal 7
	B3	JIN6	Zone Detector Input Terminal 6
	B4	JIN5	Zone Detector Input Terminal 5
	B5	GND	Grounding
	B6	GND	Grounding
	B7	JIN4	Zone Detector Input Terminal 4

Name	No.	Interface	Description
	B8	JIN3	Zone Detector Input Terminal 3
	B9	JIN2	Zone Detector Input Terminal 2
	B10	JIN1	Zone Detector Input Terminal 1

4.1.2 Terminals and Interfaces of DS-KH6310-W/ DS-KH6310

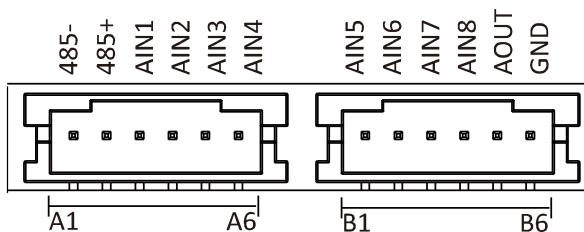

Table 4-2 Descriptions of Terminals and Interfaces

Name	No.	Interface	Description
Terminals	A1	RS485-	Reserved
	A2	RS485+	
	A3	AIN1	Zone Detector Input Terminal 1
	A4	AIN2	Zone Detector Input Terminal 2
	A5	AIN3	Zone Detector Input Terminal 3
	A6	AIN4	Zone Detector Input Terminal 4
	B1	AIN5	Zone Detector Input Terminal 5
	B2	AIN6	Zone Detector Input Terminal 6
	B3	AIN7	Zone Detector Input Terminal 7
	B4	AIN8	Zone Detector Input Terminal 8
	B5	AOUT	Alarm Relay Output
	B6	GND	Grounding

4.1.3 Terminals and Interfaces of DS-KH6310-WL/ DS-KH6210-L

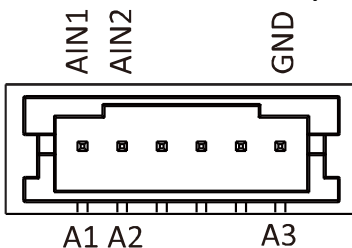

Table 4-3 Terminals Description

Name	No.	Interface	Description
Terminals	A1	AIN1	Zone Detector Input Terminal 1
	A2	AIN2	Zone Detector Input Terminal 2
	A3	GND	Grounding

4.2 Wiring Description

4.2.1 Wiring of DS-KH8301-WT/DS-KH8300-T

There are 20 pins in the terminal on the rear panel of the indoor station: 4 RS-485 pins, 4 GND pins, 4 alarm output pins, and 8 alarm input pins.

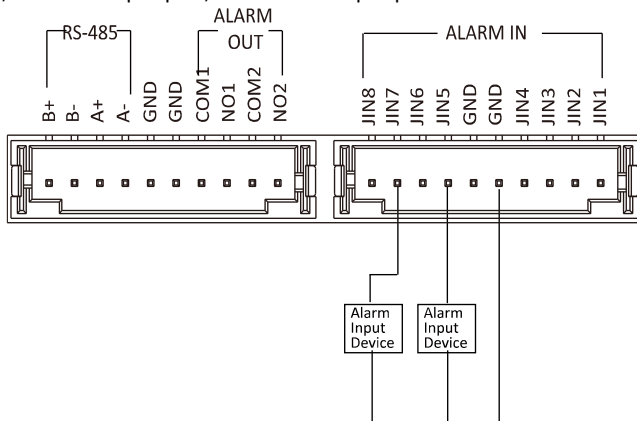

Wiring Description (Alarm Input Device)

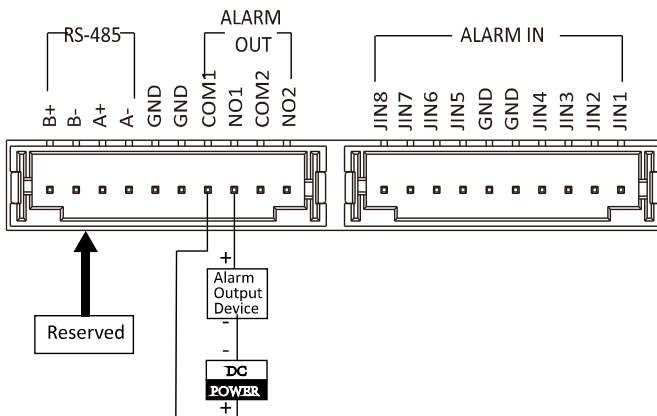

Wiring Description (Alarm Output Device)

4.2.2 Wiring of DS-KH6310-W/DS-KH6310

There are 12 pins in the terminal on the rear panel of the indoor station: 2 RS-485 pins, 1 GND pin, 1 alarm output pin, and 8 alarm input pins.

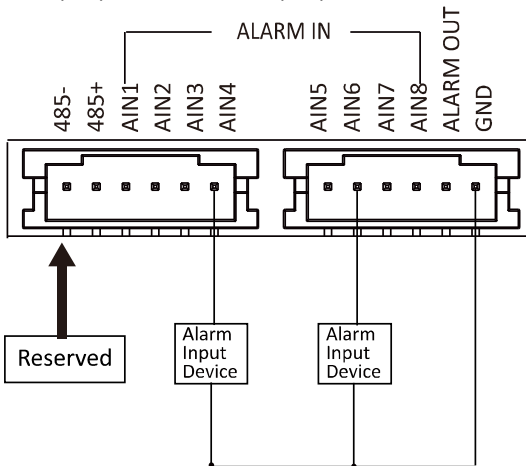

Wiring Description (Alarm Input Device)

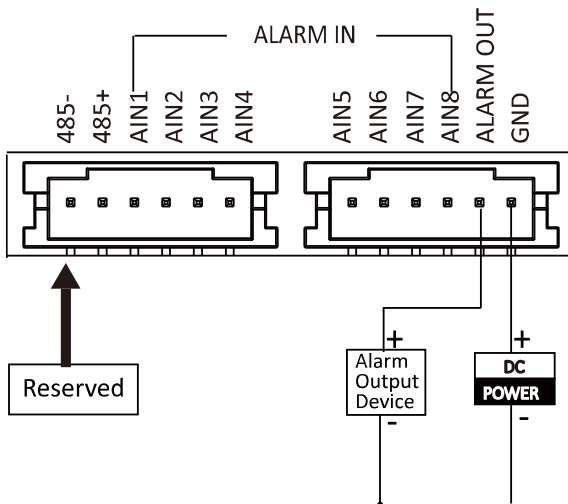

Wiring Description (Alarm Output Device)

4.2.3 Wiring of DS-KH6310-WL/DS-KH6210-L

There are 3 available pins in the terminal on the rear panel of the indoor station: 2 alarm input pins and 1 GND pin.

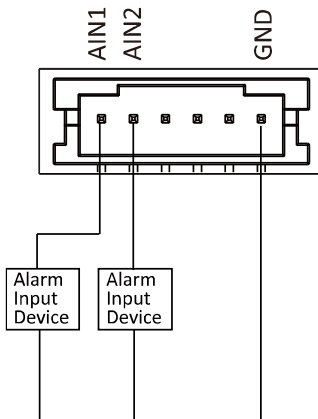

Wiring Description (Alarm Input Device)

5 Installation

5.1 Installation Accessory Description

The wall mounting plate and the gang box are required to install the indoor station onto the wall.

Gang boxes for 8-series and 6-series indoor stations are the same.

The dimension of junction box should be 75 mm (width) × 75 mm (length) × 50 mm (depth).

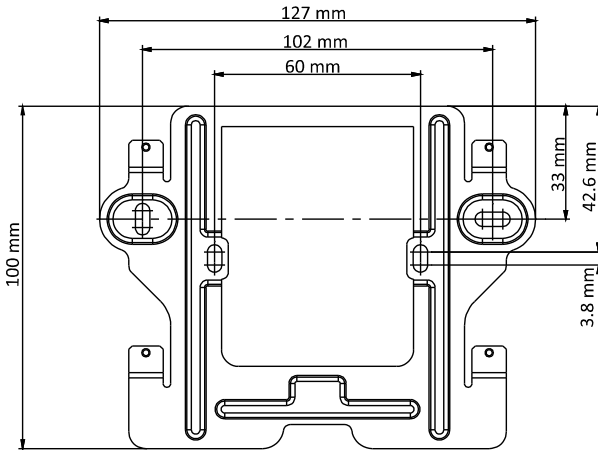

5.2 Wall Mounting with Gang Box

Wall mounting installations are the same for the 6-series indoor stations and the 8-series indoor stations. Here we take the wall mounting of DS-KH6310 model as an example.

Before you start:

- Make sure the device in the package is in good condition and all the assembly parts are included.
- The power supply the indoor station supports is 12 VDC. Please make sure your power supply matches your indoor station.
- Make sure all the related equipment is power-off during the installation.
- Check the product specification for the installation environment.

Steps:

1. Chisel a hole in the wall. The size of the hole should be 76 mm (width) × 76 mm (length) × 50 mm (depth).
2. Insert the gang box to the hole chiseled on the wall.
3. Fix the wall mounting plate to the gang box with 2 screws.

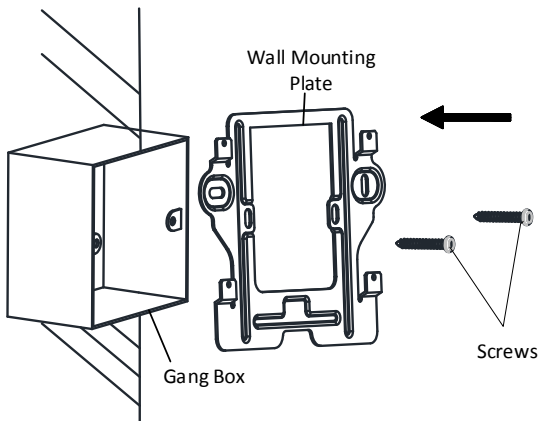

4. Hook the indoor station to the wall mounting plate tightly by inserting the plate hooks into the slots on the rear panel of the indoor station, during which the lock catch will be locked automatically.

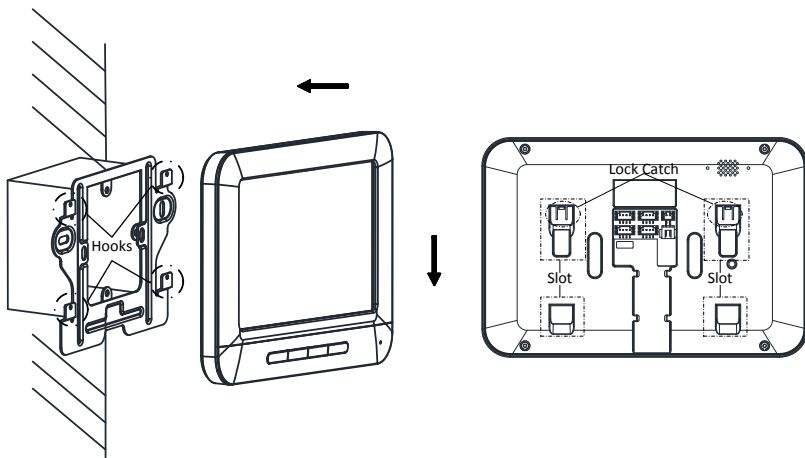

6 Local Operation



NOTE

- Here the local operation of indoor stations with touch screen is taken as example.
- The DS-KH6210-L should be operated with physical keys. The **SOS** key works as a return key; the **Unlock** key works as direction keys ▲ and ◀ to turn up and left; the **Live View** key works as direction keys ▼ and ▶ to turn down and right; and the **Management Center** key works as a confirm key.

6.1 Activate Device Locally

Steps:

1. Power on the device to enter the activation interface automatically.

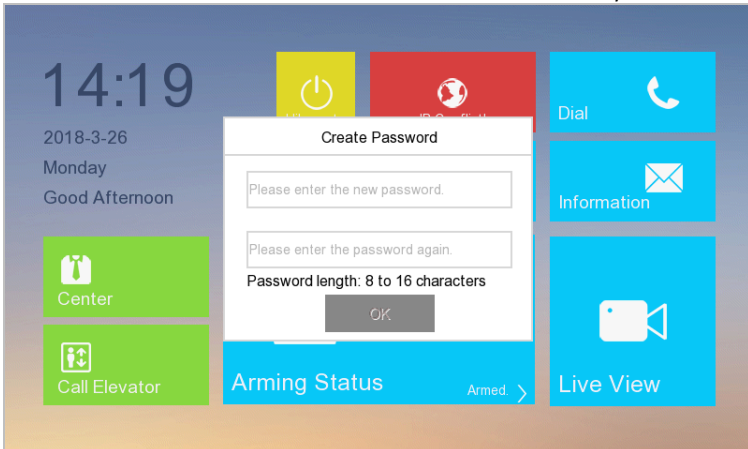

2. Create a password and confirm it.
3. Press **OK** to activate the device.

STRONG PASSWORD RECOMMENDED— We highly recommend you to create a strong password of your own choosing (using a minimum of 8 characters, including at least three kinds of following categories: upper case letters, lower case letters, numbers, and special characters) in order to increase the security of your product. And we recommend you reset your password regularly, especially in the high security system, resetting the password monthly or weekly can better protect your product.





NOTE

- You must create a password to activate the device for your first time usage and when it is not activated.
- Only when the device is activated, can you operate it locally and remotely.
- Here the activation interface of DS-KH8301-WT indoor station is taken as example.

6.2 User Interface Description

6.2.1 User Interface of Indoor Station

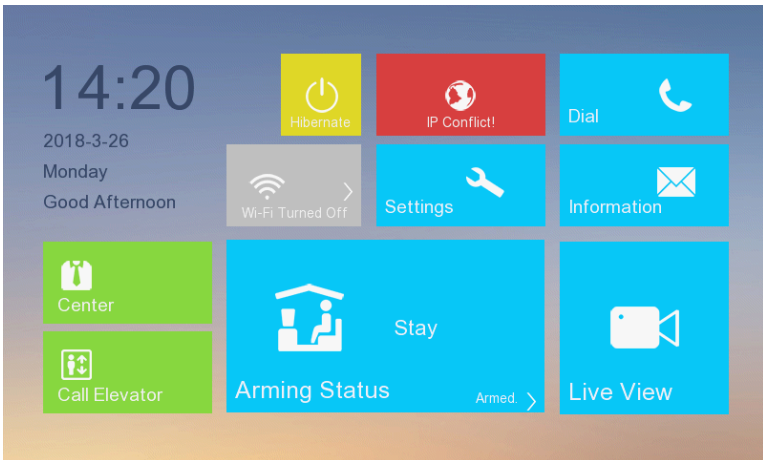

NOTE

- Here the user interface of DS-KH6310-WL is taken as example.
- Only DS-KH8301-WT/DS-KH8300-T indoor stations support TF card.

6.2.2 User Interface of Indoor Extension

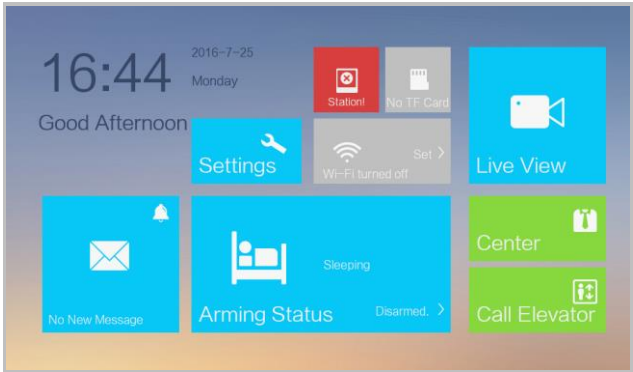





NOTE

- Only DS-KH8301-WT/DS-KH8300-T indoor extensions support TF card.
- Here the user interface of DS-KH8301-WT indoor extension is taken as example.

6.2.3 Status of Indoor Station



Table 6-1 Description of Status Icons





Icon	Definition	Description
	Normal Status.	The communication between indoor station, door station and master station is normal. And the communication between indoor station and indoor extension is normal.
	The indoor station is offline.	Please check the network cable or Wi-Fi connection.
	Exception occurs in the communication with door station.	Room No. conflict. Configure the Room No. again.
		Invalid Room No. Configure the Room No..
		Invalid main door station IP address. Configure the main door station IP address.
		Network of door station is abnormal. Check the network connection of main door station.
		Communication of door station is abnormal. Check if the door station IP address is correct.

Icon	Definition	Description
	The indoor station has not registered in the SIP server.	Invalid SIP server IP address. Set the SIP server IP address.
		Network of SIP server is not available. Check the SIP server network connection.
		SIP server communication is not available. Check if the SIP server IP address is correct.
		SIP server rejected to login the device. Check if the device No. has been registered.
	The indoor station IP address conflicts with that of other device.	Please check the IP address.
	TF card is inserted in the indoor station.	Only DS-KH8301-WT/ DS-KH8300-T Models support the TF card function.
	Exception occurs with the TF card.	
	No TF card is inserted in the indoor station.	

6.2.4 Status of Indoor Extension

Table 6-2 Description of Status Icons

Icon	Definition	Description
	Normal Status.	The communication between indoor station and indoor extension is normal.
	The indoor extension is offline.	Please check the network cable or Wi-Fi connection.
	The indoor extension IP address conflicts with that of other device.	Please check the IP address.

Icon	Definition	Description
	The indoor extension has not connected to the indoor station.	Invalid indoor station IP address. Set the indoor station IP address.
		Network of indoor station is not available. Check the indoor station network connection.
		The indoor extension number conflicts with number of another indoor extension.
	TF card is inserted in the indoor station.	Only DS-KH8301-WT/ DS-KH8300-T Models support the TF card function.
	Exception occurs with the TF card.	
	No TF card is inserted in the indoor station.	

6.2.5 Arming Status

Purpose:

4 kinds of scene modes are supported by the indoor station: Sleeping Mode, Indoor Mode, Outdoor Mode, and Custom Mode.

You can arm or disarm your room in each scene mode manually. When your room is in the arming status, the arming status will display on the main interface of the indoor station.



NOTE

No arming status module on the main interface of the DS-KH6210-L indoor station. For DS-KH6210-L indoor station, you can do arming/disarming operations through the path **Settings -> Configuration Settings -> Zone Settings**. Refer to *6.7 Zone Settings* and *6.8 Arming Mode Settings* for detailed information.

Arm Your Room

Steps:

1. Press **Arming Status** to display the arming status interface.

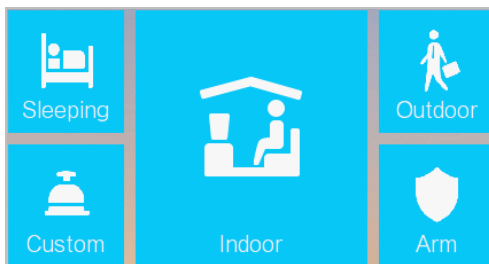

2. Press **Arm**.
3. Enter the arm password to enable the arming status.
4. (Optional) Press a scene mode icon, and enter the arm password to change the scene mode of the indoor station.

Example: After setting the arming status, press the Sleeping tab, and enter the arm password. The indoor station changes to the arming status of the sleeping mode and the interface will display as follow:

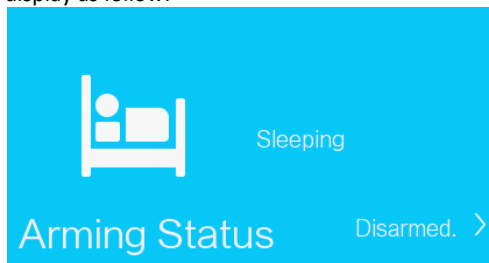

Disarm Your Room

1. Press **Arming Status** to display the arming status interface.

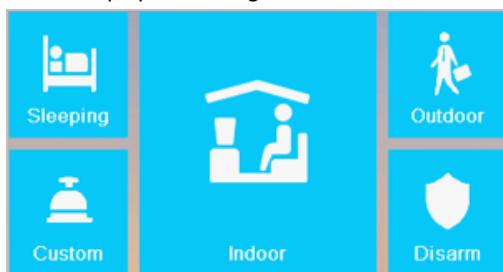

2. Press **Disarm**.
3. Enter the disarm password to enable the disarming status.
4. (Optional) Press a scene mode icon, and enter the disarm password to change the scene mode of the indoor station.



- Only one arming mode can be set at one time. When you set another mode of arming status, the former one is disarmed automatically.
- If enabling the arming status successfully, you can hear a voice prompt “armed”, and the corresponding arming status will display on the main interface.
- If enabling the disarming status successfully, you can hear a voice prompt “disarmed”, and the corresponding disarming status will display on the main interface.

6.3 Configuration Settings

Configuration settings is required before starting using the indoor station. It is necessary to set the indoor station network, room No., linked devices, device time display, and so on.

6.3.1 Set Indoor Station Network

Network connection is mandatory for the use of the indoor station. Set the network parameters after activating the indoor station. What's more, the indoor station can work normally in an intercom system only when its IP address is in the same network segment with other devices in the same system.

Set Wired Network



NOTE

The indoor station's default IP address is 192.0.0.64.

Two ways are available for you to set indoor station's IP address: DHCP, and set IP address manually.

Steps:

1. Tap **Settings** -> **Configuration** -> **Network** to go to the network settings page.



NOTE

Default admin password is 888999.

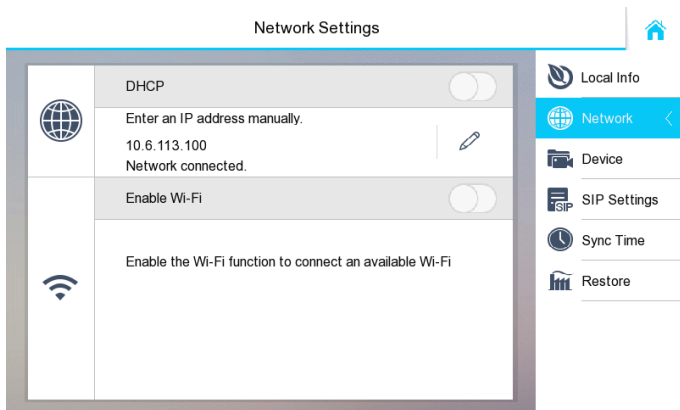



2. Enable **DHCP**, then the indoor station can search and get an IP address automatically.

 **NOTE**

Skip the following steps if you have set an IP address for the indoor station by DHCP function.

3. Set the IP address manually.

- 1) Tap  to pop up the network parameters settings dialog box.

 Network Settings

Local IP

Subnet Mask

Gateway

- 2) Enter IP address, subnet mask, and network gateway.
4. Tap **OK**.

Set Wi-Fi

Some indoor station support Wi-Fi connection.

Enable **Enable Wi-Fi**, and the indoor station can search the Wi-Fi.

6.3.2 Set SIP Sever

A SIP server connection is required and necessary for the indoor station to guarantee the connection between the indoor station and the management center (master station) in the same video intercom system.

2 types of SIP protocol are available for the indoor station: Private Protocol, and Standard Protocol.

**NOTE**

Rebooting the indoor station is required when you switch the SIP protocol between the private SIP protocol and the standard SIP protocol.

All linked device IP should be configured again after you change the SIP protocol type.

The indoor extension does not support SIP sever settings.

Set Private SIP

The SIP server IP is required for you to set when you select Private Protocol, and the SIP IP must be in the same network segment with the intercom devices in the system.

Steps:

1. Go to SIP Settings page to select SIP protocol type: **Settings -> Configuration -> SIP Settings.**

2. Select **Private Protocol.**

**NOTE**

- Default admin password is 888999.
- The default SIP protocol is private protocol.

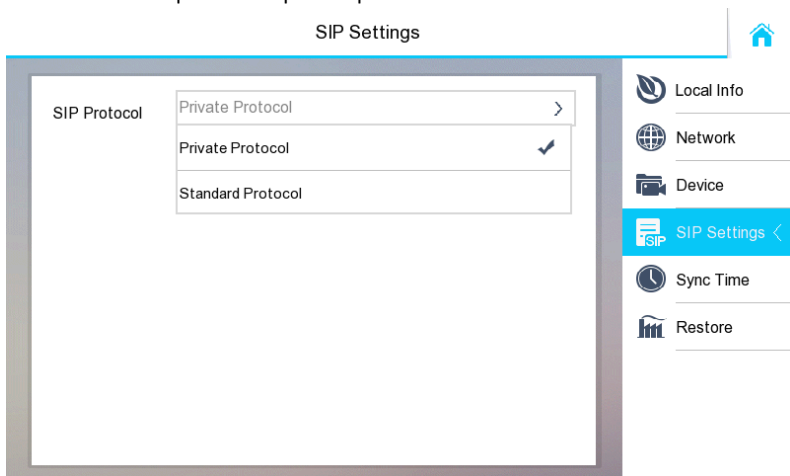

3. Tap **Device** to go to the device management page.

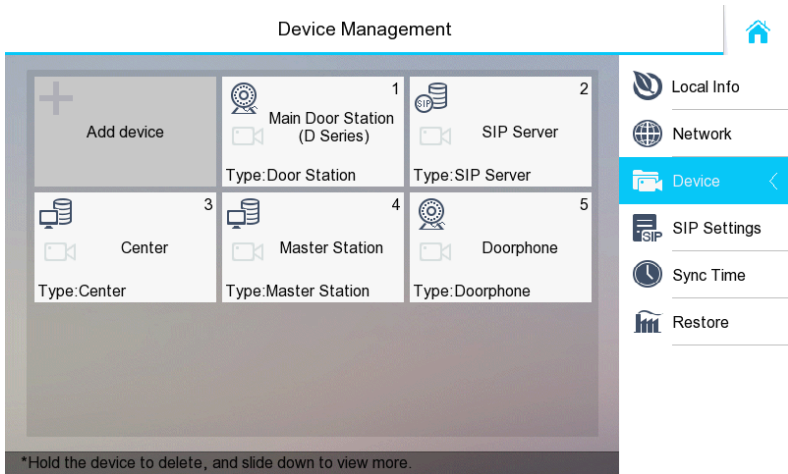

4. Tap **SIP Sever**, and enter the IP address of the SIP server.
5. Tap  to save the SIP server added.

Set Standard SIP

With the standard SIP, your indoor station can connect to any intercom device, software client, and phones which also support the standard SIP.

Before you Start:

Make sure you have added a VoIP account in the standard SIP server.

Steps:

1. Go to SIP Settings page to select SIP protocol type: **Settings -> Configuration -> SIP Settings.**
2. Select **Standard Protocol.**

NOTE

- Default admin password is 888999.
- The default SIP protocol is private protocol.
- Rebooting the indoor station is required when you change to **Standard Protocol** from **Private Protocol.**

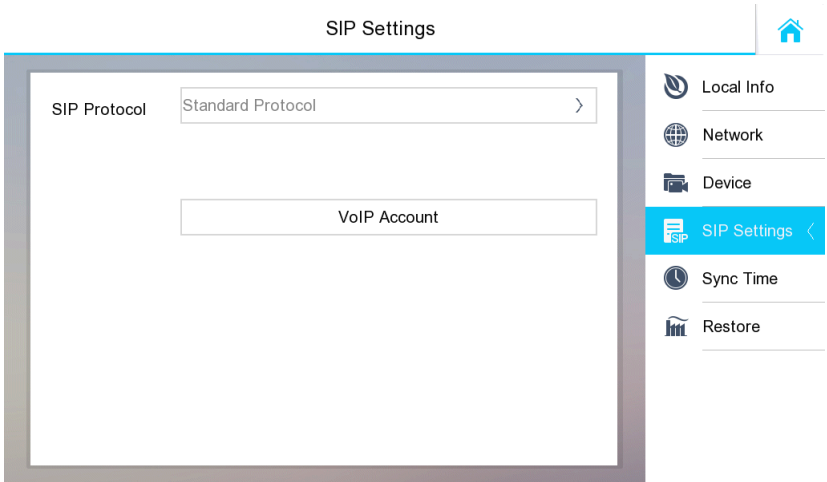



3. Set VoIP account.

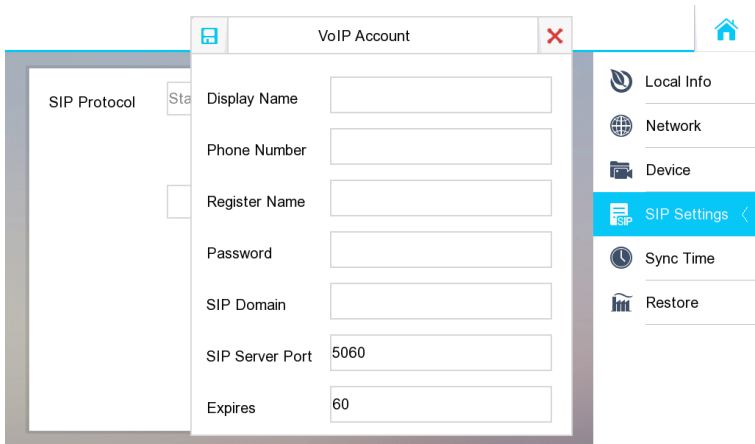

NOTE

- The account you entered here must be the same with the account you added in the standard SIP server.
- The phone number should be a numeric, which is up to 16 digits. And the phone number will be the number you dial when you want to call the indoor station via standard SIP.



4. Tap  to save the standard SIP settings.

6.3.3 Set Linked Device IP

Linked network parameters refers to the network parameters of devices (like door station, doorphone, master station, center, etc.), to which the indoor station is linked. Linked devices for the indoor station refers to door station, center, master station, and doorphone.

With the private SIP protocol, intercom can be realized only when all these devices are in the same network segment with the indoor station.

With the standard SIP protocol, intercom can be realized when all these devices support the standard SIP protocol.



NOTE

- The doorphone does not support adding with the standard SIP protocol.
- Here take door station network settings as example.

Steps:

1. Tap **Settings** -> **Configuration** -> **Device** to go to the device management page.



NOTE

Default admin password is 888999.

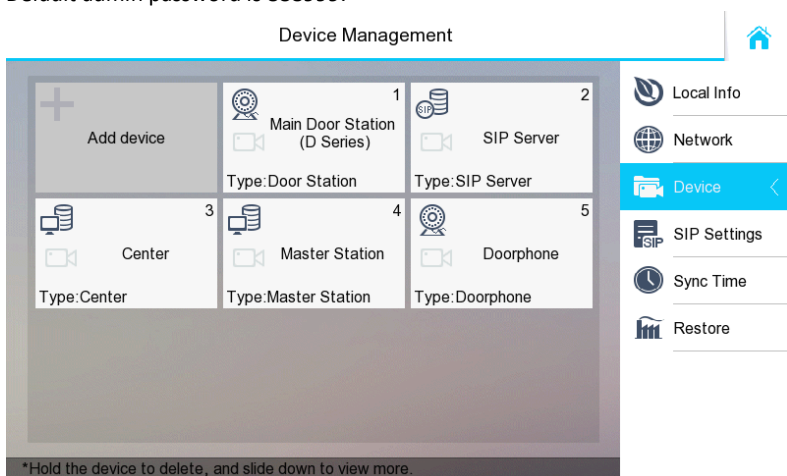

Device Management (Private SIP)

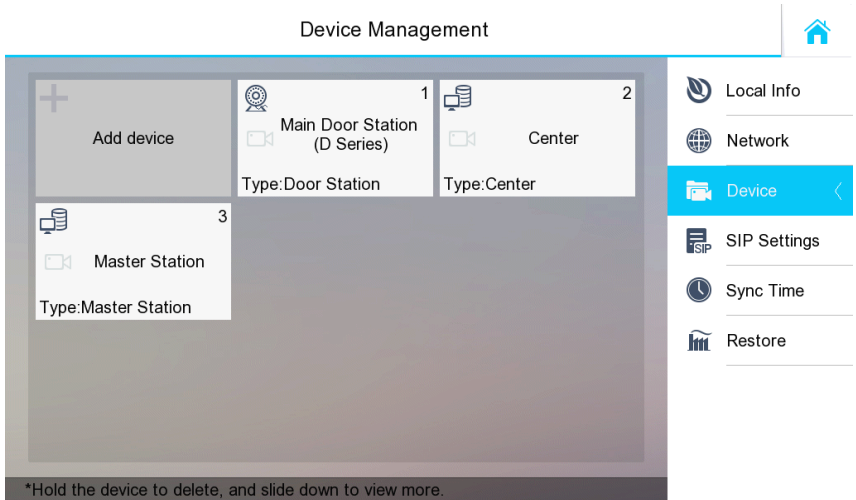

Device Management (Standard SIP)

2. Tap **Main Door Station** to pop up the device information dialog box.

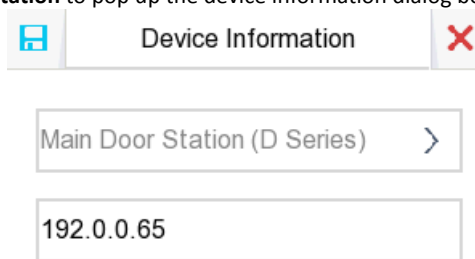

3. Select a door station type based on your actual door station type, and set the door station IP address.

6.3.4 Set Indoor Station No.

Indoor station No. and the indoor extension No. are numbers, which can be dialed by other devices to call the indoor station and the indoor extension in an intercom system. The indoor station No., is composed of the floor No. and the room No. For example, the indoor station No. 401 refers to the room 1 on the fourth floor, and the indoor station No. 512 refers to the room 12 on fifth floor, and the indoor station 2302 refers to the room 2 on the 23rd floor.

The indoor extension No. Should be a numeric from 1 to 5.

Up to 5 indoor extensions can be set for 1 indoor station.

Steps:

1. Tap **Settings** -> **Configuration** -> **Local Info** to go to the indoor station No. settings page.



Default admin password is 888999.

2. Select **Indoor Station** to set the indoor station No. (Room No.) and the floor No.

For Example:

When set the Room No. as 2, and the Floor No as 2, then the indoor station No. is 202.

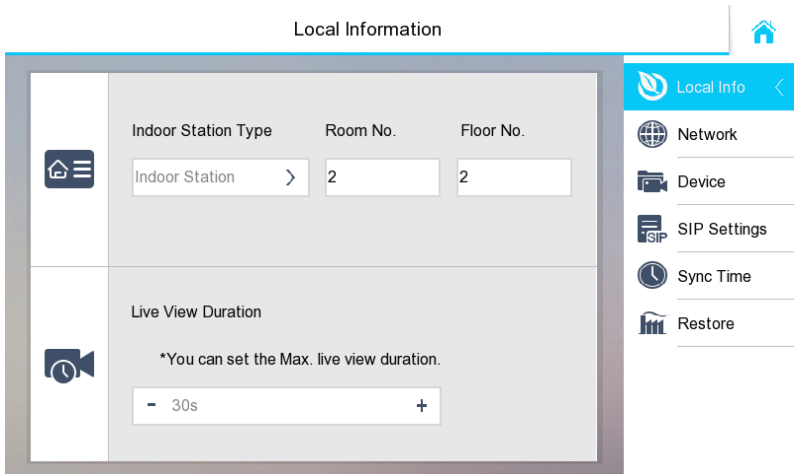

3. Select **Indoor Extension** to set the indoor extension No. and the room name.

For Example:

Set the indoor extension No. as 1, and the room name as Hello Room.

What to do next

You can press 201 on the door station to call the indoor station, and press 1 on the indoor station to call indoor extension.

6.3.5 Add Camera

The indoor station supports connecting cameras, so that get the live view of camera on the live view page.



The highest resolution of the IP camera added to the indoor station is 1280 x 720 @ 30 fps, and the video compression standard of the IP camera should be H.264.

Steps:

1. Tap **Settings** -> **Configuration** -> **Device** to go to the device management page.



Default admin password is 888999.

2. Tap **Add device**.

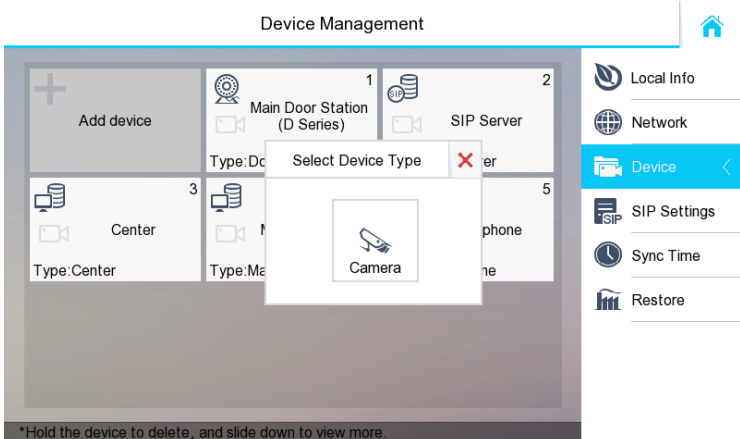

3. Tap Camera, and enter the corresponding information (device name, IP address, port No., password, etc.).

4. Tap  to save the settings.

6.3.6 Synchronize Time

Steps:

1. Tap **Settings -> Configuration -> Sync Time** to enter the time synchronization page.

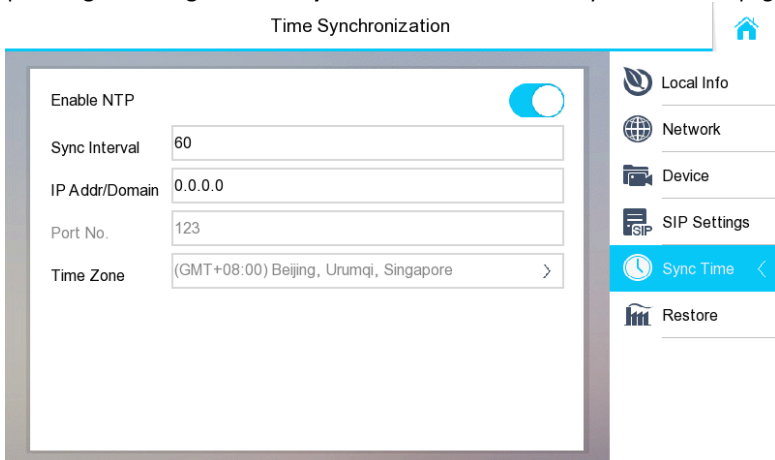

2. Enable **Enable NTP**.

3. Set the synchronizing interval, enter the IP address/domain of NTP server and port No., and select the time zone



NOTE

The default unit of synchronizing interval is minute.

6.3.7 Restore Indoor Station

Steps:

1. Tap **Settings** -> **Configuration** -> **Restore** to enter the Restore Default Settings page.

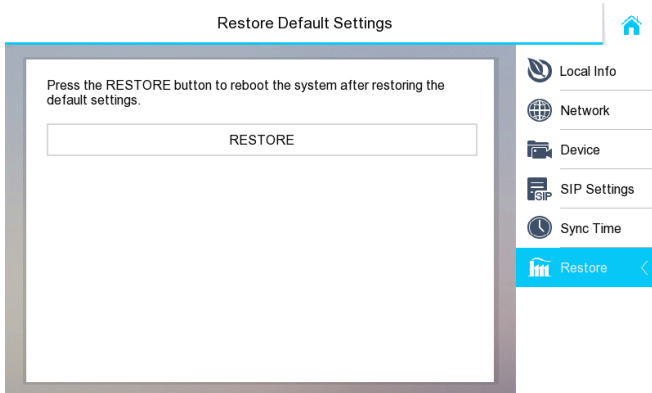

2. Tap **RESTORE** to restore the default settings and reboot the system.

6.4 Password Settings

Purpose:

You can edit the admin password (configuration password), duress code, unlock password and arm/disarm password of the indoor station.

You can edit the admin password (configuration password) and arm/disarm password of the indoor extension.

Steps:

1. Tap **Settings** -> **Password** to enter the password settings page.

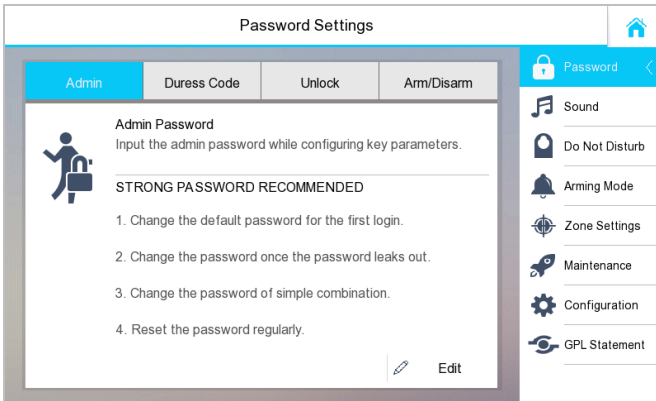

2. Tap **Admin Password**, **Duress Code**, **Unlock Password**, or **Arm/Disarm Password** to enter corresponding pages.
 - **Admin Password:** You cannot configure parameters for the indoor station without entering the admin password.
 - **Duress Code:** When you are hijacked and forced to open the door, you can enter the duress code, and meanwhile an alarm is triggered to notify the management center secretly.
 - **Unlock Password:** Entering the unlock password and room No. on the door station, you can open the door.
 - **Arm/Disarm Password:** You cannot arm or disarm the zone for the indoor station without entering the arming/disarming password first.



NOTE

You cannot set the same password for the duress code and the unlock password.

3. Tap **Edit** to pop up the password changing dialogue box.



4. Enter the old password to change it
5. Enter the new password and confirm it.

6. Tap  to save the settings.



NOTE

- The default admin password (configuration password) is **888999**.
- The default arm/disarm password, and scene password are **123456**.
- Indoor Extension only supports admin password and arm/disarm password.

6.5 Sound Settings

Purpose:

You can set the ringtone, ring duration, call forwarding time, volume of microphone and loudspeaker, enable/disable touch sound and auto-answer function on sound settings interface.

Steps:

1. Get to the sound settings interface: **Settings -> Sound Settings**.

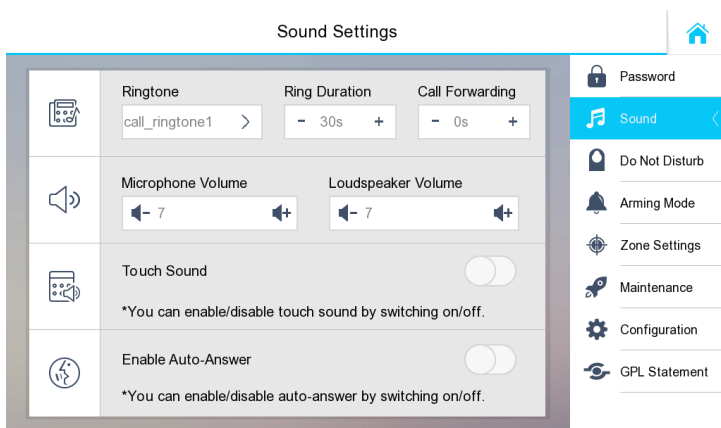

2. Set corresponding parameters.

Ringtone: There are 3 ringtones by default, and you can custom and import at most 4 ringtones via Batch Configuration Tool or iVMS-4200 Client Software.

Ring Duration: The maximum duration of indoor station when it is called without being accepted. Ring duration ranges from 30s to 60s.

Call Forwarding (Time): The ring duration limit beyond which the call is automatically forwarded to eh mobile phone designated by the resident. Call forwarding (time) ranges from 0s to 20s.

Enable Auto-Answer: After enabling the auto-answer function, the visitor can leave the voice message to the indoor station from the door station, the master station, or the client software.

**NOTE**

- Auto-answer function is only available to 8-series indoor stations with TF card function and 6-series indoor stations.
- Indoor Extension does not support the ring duration settings, call forwarding settings, or auto-answer function.

6.6 Do Not Disturb Settings

Purpose:

Two types of no disturbing mode can be configured: **All day** and **Scheduled**.

Steps:

1. Get to the no disturbing settings interface: **Settings -> Do Not Disturb**.

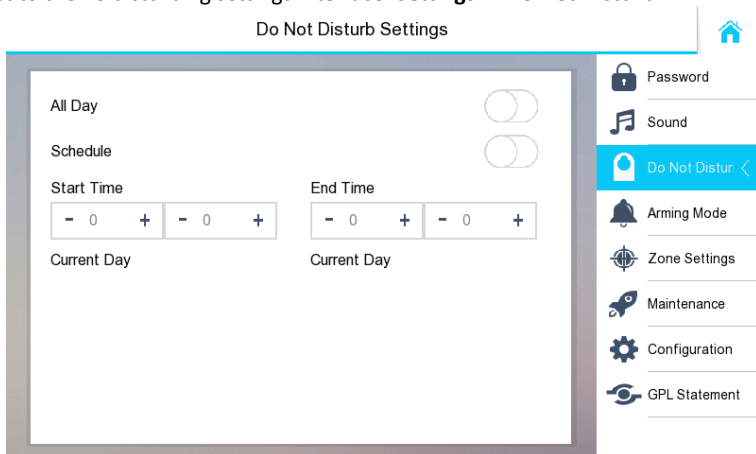



2. Select no disturbing mode: **All Day** or **Scheduled**.

- **All Day:**

- 1) Switch  to  to enable do not disturb mode.

- **Scheduled:**

- 1) Switch  to  to enable do not disturb mode.
- 2) Set the start time and the end time.

**NOTE**

- Under all-day no disturbing mode, the indoor station will not ring all day when it is called by door station or other indoor stations, but the call logs will be saved.
- Under scheduled no disturbing mode, the indoor station will not ring between the start time and the end time when it is called by door station or other indoor stations, but the call logs will be saved.

- Indoor extension does not support Do Not Disturb Settings.

6.7 Zone Settings

Purpose:

You can set the zone type, alarm type and delay time and other parameters of 8 zones.

Steps:

1. Get the zone settings interface: **Settings -> Zone Settings**.

The screenshot shows the 'Zone Settings' interface. At the top, there is a title bar 'Zone Settings' with a home icon on the right. Below the title bar is a table with 8 rows, each representing a zone. The table has columns for 'Zone No.', 'Zone Type', 'NO/NC', 'Alarm Type', and 'Delay Time'. To the right of the table is a sidebar menu with various settings options, including 'Zone Settings' which is highlighted in blue.

Zone No.	Zone Type	NO/NC	Alarm Type	Delay Time
Zone 1	Smoke Detector	NO	24h Alarm	0s/0s
Zone 2	Gas Detector	NO	24h Alarm	0s/0s
Zone 3	Active Infrared	NO	Delay Alarm	30s/30s
Zone 4	Active Infrared	NO	Delay Alarm	30s/30s
Zone 5	Active Infrared	NO	Delay Alarm	30s/30s
Zone 6	Active Infrared	NO	Delay Alarm	30s/30s
Zone 7	Active Infrared	NO	Delay Alarm	30s/30s
Zone 8	Active Infrared	NO	Delay Alarm	30s/30s

2. Press a zone to pop up the zone editing dialogue box.

The screenshot shows the 'Edit Zone' dialog box. It has a title bar 'Edit Zone' with a save icon on the left and a close icon on the right. The dialog contains five rows of settings, each with a label and a value field with a right-pointing arrow:

- Zone Type: Smoke Detector
- Alarm Type: 24h Alarm
- NO/NC: NO
- Enter Delay: - 0s +
- Exit Delay: - 0s +

3. Set the zone type, alarm type, status of arming status, entering delay, and exiting delay.

4. Press the  tab to save the settings.

 **NOTE**

- 7 zone types are selectable: Panic Button, Door Magnetic, Smoke Detector, Active Infrared, Passive Infrared, Gas Detector, and Doorbell.
- 3 alarm types are selectable: 24h Alarm, Instant Alarm, and Delay Alarm.
 - Set the alarm type as 24h alarm, and the zone will be armed for 24h.
 - Set the alarm type as instant alarm, and the zone will alarm once it's triggered.
 - Set the alarm type as delay alarm, and you should set the entering delay duration and exiting delay duration.
- Both the entering delay duration and the exiting delay duration are from 30s to 60s.
- For Gas Detector and Smoke Detector, the alarm type is set as default 24h alarm.
- The DS-KH6210-L and DS-KH6310-WL indoor stations only support 2 zones.

6.8 Arming Mode Settings

Purpose:

4 arming modes can be configured: outdoor mode, indoor mode, sleeping mode and custom mode.

Steps:

1. Get to the arming mode settings interface: **Settings -> Arming Mode.**

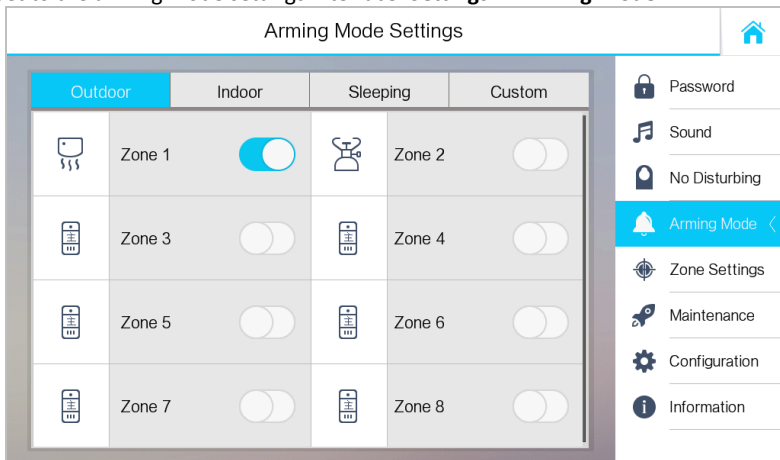

2. Press **Outdoor Mode** tab, **Indoor Mode** tab, **Sleeping Mode** tab, and **Custom Mode** tab to enter corresponding arming mode settings interface.
3. Switch to to enable the arming in the selected zoon.

NOTE

- Zones in each arming mode can be configured manually.



- For 24H alarm zone and smoke detector zone, even if it is disabled under current arming mode, the indoor station will still alarm when it is triggered.
- Arming mode settings should be configured with the settings of arming status on the user interface of the device.
- The DS-KH6210-L and DS-KH6310-WL indoor stations only support 2 zones.

6.9 System Maintenance

Purpose:

You can format or install TF card, clear the screen, view the version information of the indoor station and reboot the system on the system maintenance interface.

Steps:

1. Get to the system maintenance interface: **Settings** -> **Maintenance**.
2. Press the **Format** tab to format the TF card.
3. Press the **Uninstall** tab to uninstall the TF card.
4. Switch  to  to enable the clear screen mode.
5. Press the **Reboot** tab to reboot the system.
6. Set the system language.

The indoor station supports English, Russia, French, Portugal, Spanish.

7. You can set the system language for the indoor station.

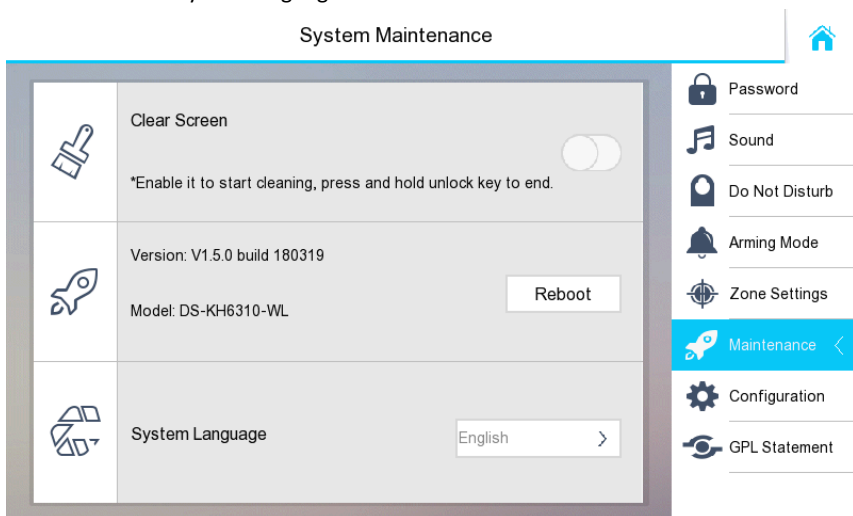

NOTE

- Only DS-KH8300-T/DS-KH8301-WT indoor stations support TF card function.

- After enabling Clear Screen function, press and hold the **Unlock** key () to exit the clear screen mode.

6.10 Call Settings

6.10.1 Add Contact

Steps:

1. Press the  **Contact List** tab on the user interface to enter the contact list interface.

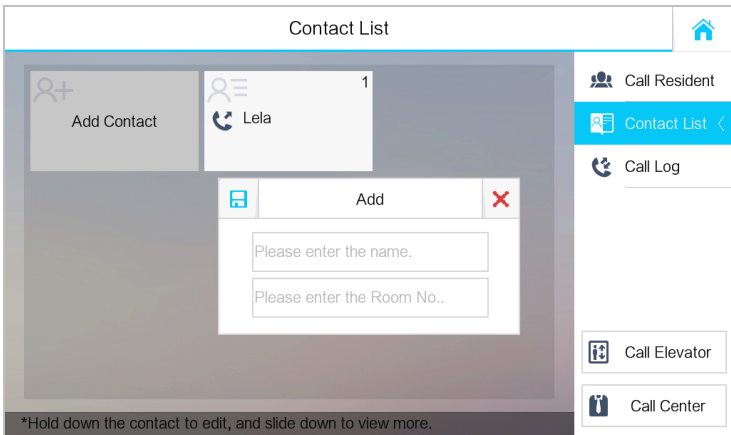

2. Press the **Add Contact** tab to pop up the contact adding dialogue box.
3. Enter contact information.
 - With private SIP protocol**, enter the contact name and the room No.
 - With standard SIP protocol**, enter the contact name and the phone number of VoIP account.
4. Press the  tab to save the settings.

 **NOTE**

- Up to 200 contacts can be added.
- Hold an added contact to open the contact handling menu.

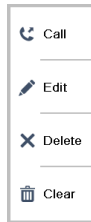

- Press the **Call** tab to start the video call with the contact.
- Press the **Edit** tab to modify the contact information.
- Press the **Delete** tab to delete the contact.
- Press the **Clear** tab to delete all contacts added in the indoor station.
- Indoor extension does not support this function.
- The DS-KH6210-L does not support this function.

6.10.2 Call Resident

Steps:







1. Press the  tab on the touch screen to enter the residents calling interface.
2. Enter the calling number.

With private SIP protocol, the calling number format should be like 1-2-3-405 as Community 1, Building 2, Unit 3, and Room 405. The community No. can be omitted.

With standard SIP protocol, the calling number should be the phone number of VoIP account.



NOTE

- Press the  tab to start an audiovisual call.
- Press the  tab to stop the audiovisual call.
- Switch  to  on the upper right corner to enable the camera function.
- Indoor extension does not support this function.
- On the call resident interface of DS-KH6210-L, there is no **Contact List**, **Call Elevator**, or **Call Center** tab.

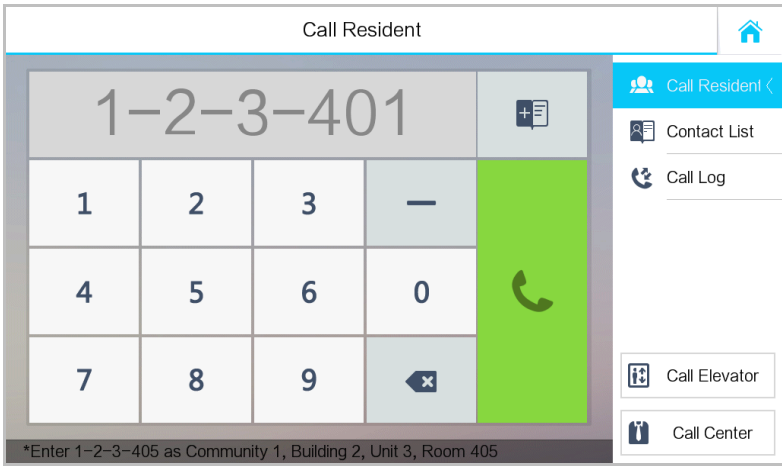

6.10.3 Call Indoor Extension/Indoor Station

If you install indoor station and indoor extensions at home, you can call the indoor extension via your indoor station, and vice versa.

Enter the indoor extension No. on the indoor station to start calling.

Enter the numeric symbol 0 to call the indoor station from the indoor extension.

6.10.4 Call Center

2 options are selectable to call management center.

Option 1:



Press the tab **Center** on the main interface of the indoor station.

Option 2:



Press the tab **Call Center** on the speaking interface or the live view interface.

 **NOTE**

- Management center here refers to the master station and iVMS-4200 client software.
- For indoor extension, it only supports calling the master station.

6.10.5 Receive Call

Purpose:

The indoor station can receive calls from the door station, the master station, or iVMS-4200 client software.

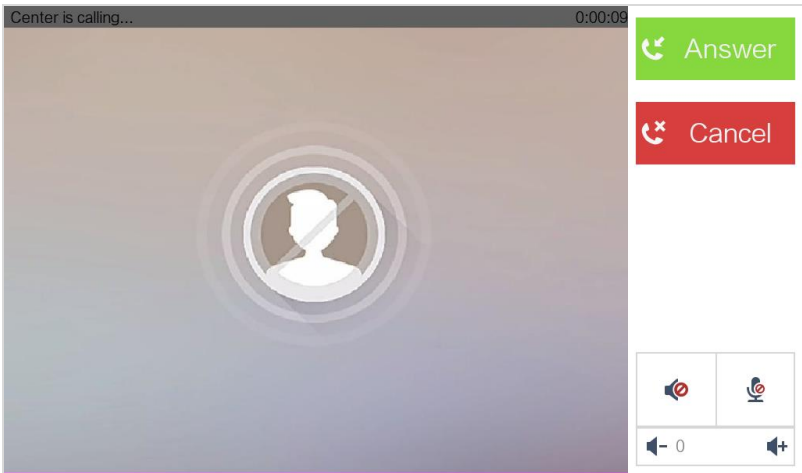

Call from Center (Master Station or iVMS-4200)

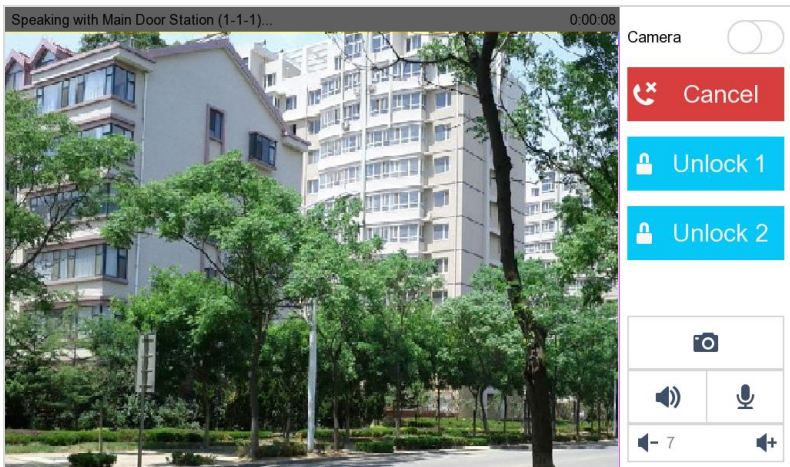

Call from Door Station

On the call from door station interface, there are 2 unlock buttons: **Unlock 1**, and **Unlock 2**. When you press **Unlock 1**, the building gate will open by default, and when you press **Unlock 2**, the door connected to the door station with the secure control door unit will open.

Press the  tab to capture the live view picture when speaking with the door station. And prompts "Captured" will display on the screen.

Indoor extension can receive the call from the door station and the master station only.

6.10.6 View Call Logs

Steps:



1. Press the  tab on the touch screen to enter the call log interface.

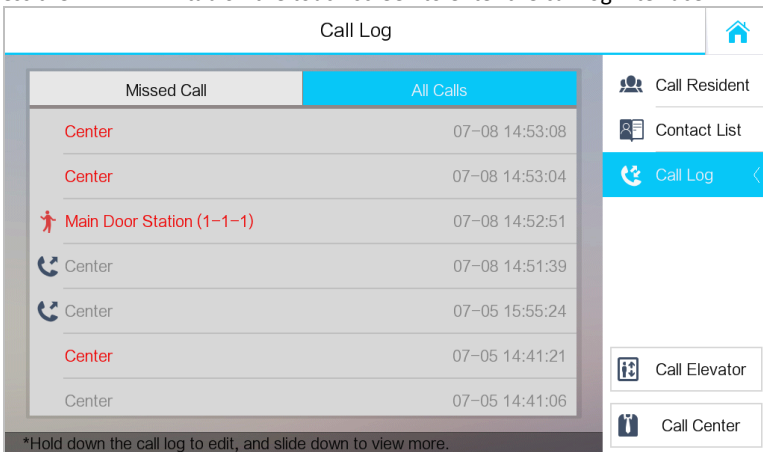

2. Press tab **Missed Call** or **All Calls** to view missed call logs or all call logs.



NOTE

- Indoor extension does not support this function.
- The indoor station saves call logs from door station, outer door station, management center and other indoor stations.
- Hold a piece of call log to open the call log handling menu.

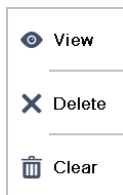

- Press the **View** tab to enter the live view interface.
- Press the **Delete** tab to delete the piece of call log.
- Press the **Clear** tab to delete all pieces of call logs.
- For the DS-KH6210-L, select a piece of call log and press the **Confirm** key to pop up the captured picture.

6.11 Live View

NOTE

- Make sure the IP camera or door station is well-connected.
- Make sure the indoor extension and the indoor station are well-connected.
- The DS-KH6210-L indoor station only supports getting the live view of IP camera.

Purpose:

On the live view interface, you can monitor the live view of added door station and IP camera.

Steps:

1. Press the **Live View** tab on the user interface to enter the live view interface.

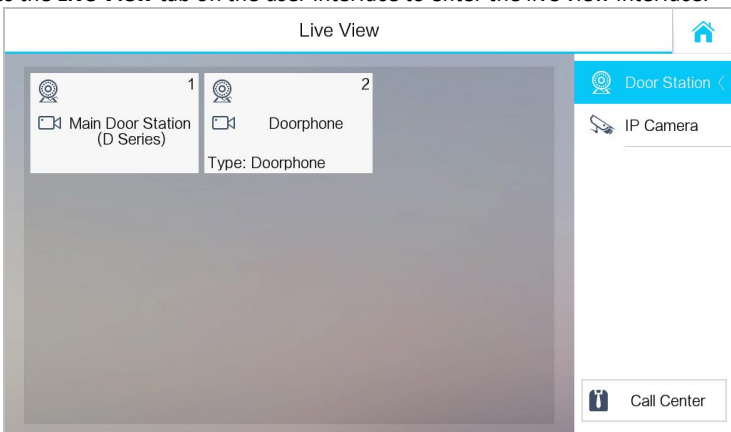

2. Press the **Door Station** tab to enter the live view interface of door station.

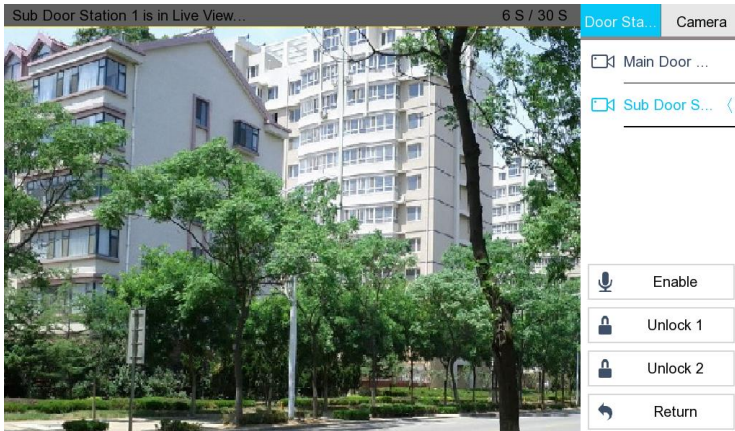

**NOTE**

On the call from door station interface, there are 2 unlock buttons: Unlock 1, and Unlock 2. When you press **Unlock 1**, the building gate will open by default, and when you press **Unlock 2**, the door connected to the door station with the secure control door unit will open.

3. Press the **IP Camera** tab to enter the live view interface of IP cameras.

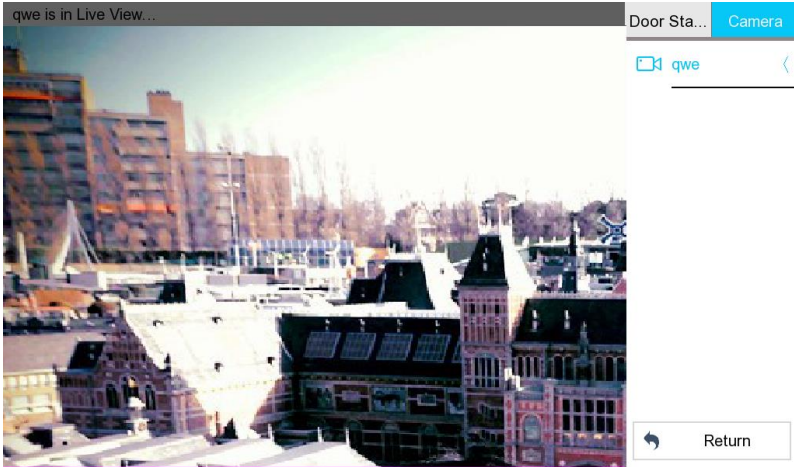

6.12 Information Management

You can view public notice, visitor message, alarm log and capture log on information management interface.

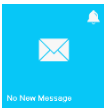

Press the **No New Message** tab or the **Information Management** tab to enter the information management interface. (Here take the alarm log interface as example.)



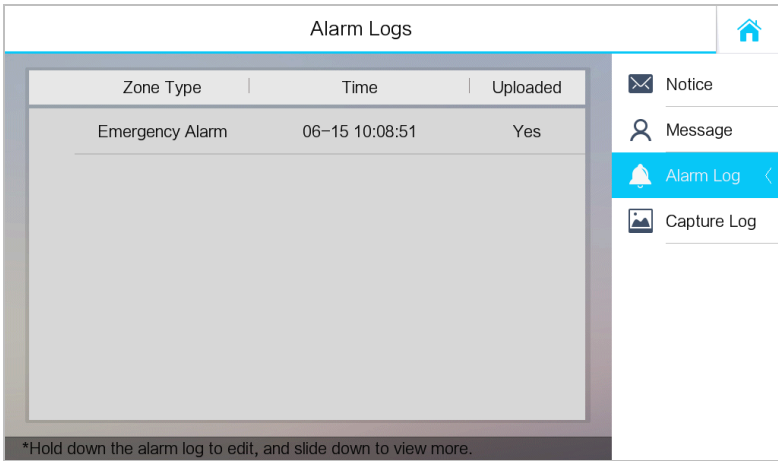

NOTE

- Indoor extension only supports alarm log and capture log.
- For DS-KH8300-T models, it requires TF card for saving the notice, visitor messages and capture logs of the indoor stations, and requires the internal memory of the indoor station to save the alarm log.
- For DS-KH6310/DS-KH6310-W/DS-KH6310-WL/DS-KH6210-L models, it is the internal memory of the indoor station that saves the notice, visitor messages, alarm logs, and capture logs.
- Up to 200 pieces of notice, 200 pieces of visitor messages, 200 pieces of alarm logs, and 200 pieces of capture logs can be saved.
- Hold the item to delete or clear all items on each interface.
- On the alarm log interface (indoor station), hold the piece of the alarm log to open the alarm details interface.

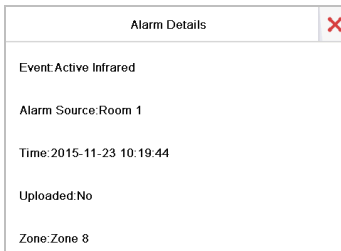

7 Remote Operation via Batch Configuration Tool

You can configure and operate the video intercom devices via Batch Configuration Tool.

Default parameters of indoor station are as follows:

- Default IP Address: 192.0.0.64.
- Default Port No.: 8000.
- Default User Name: admin.

7.1 Activate Device Remotely

Purpose

You are required to activate the device first by setting a strong password for it before you can use the device.

Activation via Batch Configuration Tool, and Activation via iVMS-4200 are supported. Here take activation via Batch Configuration Tool as example to introduce the device activation. Please refer to the user manual for the activation via iVMS-4200.

Steps:

1. Run the Batch Configuration Tool.

Online Devices: 5							
Edit NET Parameters Reset Password Activate							
Index	Device Type	IP Address	Port	Software Version	Serial No.	Security Status	Added
1	XX-XXXX-XX	10.16.2.77	8000	Vk.x.x build xxxxxx	XX-XXXXXX-XXXXXXXXXXXXXXXXXXXXXXXXXXXX	Activated	Yes
2	XX-XXXX-XX	10.16.2.103	8000	Vk.x.x build xxxxxx	XX-XXXXXX-XXXXXXXXXXXXXXXXXXXXXXXXXXXX	Activated	No
3	XX-XXXX-XX	10.16.2.114	8000	Vk.x.x build xxxxxx	XX-XXXXXX-XXXXXXXXXXXXXXXXXXXXXXXXXXXX	Activated	No
4	XX-XXXX-XX	10.16.2.222	8000	Vk.x.x build xxxxxx	XX-XXXXXX-XXXXXXXXXXXXXXXXXXXXXXXXXXXX	Activated	No
5	XX-XXXX-XX	192.0.0.64	8000	Vk.x.x build xxxxxx	XX-XXXXXX-XXXXXXXXXXXXXXXXXXXXXXXXXXXX	Inactive	No

2. Select an inactivated device and click **Activate**.

Activate

Password:

Valid password range [8-16].
You can use a combination
of numbers, lowercase,
uppercase and special
character for your password
with at least two kinds of
them contained.

Confirm password:

3. Create a password, and confirm the password.

STRONG PASSWORD RECOMMENDED– We highly recommend you create a strong password of your own choosing (Using a minimum of 8 characters, including at least three of the following categories: upper case letters, lower case letters, numbers, and special characters.) in order to increase the security of your product. And we recommend you reset your password regularly, especially in the high security system, resetting the password monthly or weekly can better protect your product.



4. Click **OK** to activate the device.

 **NOTE**

- When the device is not activated, the basic operation and remote operation of device cannot be performed.
- You can hold the **Ctrl** or **Shift** key to select multiple devices in the online devices, and click the **Activate** button to activate devices in batch.



7.2 Edit Network Parameters

Purpose:

To operate and configure the device via LAN (Local Area Network), you need connect the device in the same subnet with your PC. You can edit network parameters via batch configuration tool, and iVMS-4200 software. Here take editing network parameters via batch configuration tool as example.

Steps:

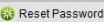
1. Select an online activated device and click the **Edit NET Parameters** button.

Online Devices: 6								
    								
Index	Device Type	IP Address	Port	Software Version	Serial No.	Security Status	Added	
1	XX-XXXX-XX	192.0.0.64	8000	Vx.x.x build xxxxxx	XX-XXXX-XXXXXXXXXXXXXXXXXXXX...	Activated	No	
2	XX-XXXX-XX	10.16.6.155	8000	Vx.x.x build xxxxxx	XX-XXXX-XXXXXXXXXXXXXXXXXXXX...	Activated	No	
3	XX-XXXX-XX	10.16.6.179	8000	Vx.x.x build xxxxxx	XX-XXXX-XXXXXXXXXXXXXXXXXXXX...	Activated	No	
4	XX-XXXX-XX	10.16.6.126	8000	Vx.x.x build xxxxxx	XX-XXXX-XXXXXXXXXXXXXXXXXXXX...	Activated	No	
5	XX-XXXX-XX	10.16.6.151	8000	Vx.x.x build xxxxxx	XX-XXXX-XXXXXXXXXXXXXXXXXXXX...	Activated	No	
6	XX-XXXX-XX	10.16.6.222	8000	Vx.x.x build xxxxxx	XX-XXXX-XXXXXXXXXXXXXXXXXXXX...	Activated	No	

2. Change the device IP address and gateway address to the same subnet with your computer.
3. Enter the password and click the OK button to activate the network parameters modification.

Edit NET Parameters	
IP Address:	10.16.6.159
Subnet Mask:	255.255.255.0
Gateway Address:	10.16.6.254
Port No.:	8000
Password:	
<input type="checkbox"/> Enable DHCP	
<input type="button" value="OK"/> <input type="button" value="Cancel"/>	

**NOTE**

- The default port No. is 8000.
- The default IP address of the indoor station is 192.0.0.64.
- After editing the network parameters of device, you should add the devices to the device list again.
- Enable DHCP, and the software can obtain network parameters for the device automatically.

7.3 Add Device

Before you start:

Make sure the device to be added has been activated.

Purpose:

For batch configuration tool software, you should add device to the software so as to configure the device remotely.

The software provides 3 ways for adding the devices. You can add the active online devices within your subnet, add devices by IP address, and add devices by IP segment.

7.3.1 Add Online Device

Before you start:

Make sure the device to be added is in the same subnet with your computer. Otherwise, please edit network parameters first.

Steps:

1. Select an active online device or hold the **Ctrl** or **Shift** key to select multiple devices in the online devices list.

Index	Device Type	IP Address	Port	Software Version	Serial No.	Security Status	Added
1	XX-XXXX-XX	10.16.2.77	8000	Vx.x.x build xxxxxx	XX-XXXX-XXXXXXXXXXXXXXXXXXXXXX	Activated	Yes
2	XX-XXXX-XX	10.16.2.114	8000	Vx.x.x build xxxxxx	XX-XXXX-XXXXXXXXXXXXXXXXXXXXXX	Activated	No
3	XX-XXXX-XX	10.16.2.103	8000	Vx.x.x build xxxxxx	XX-XXXX-XXXXXXXXXXXXXXXXXXXXXX	Activated	No
4	XX-XXXX-XX	10.16.2.88	8000	Vx.x.x build xxxxxx	XX-XXXX-XXXXXXXXXXXXXXXXXXXXXX	Activated	No
5	XX-XXXX-XX	10.16.2.222	8000	Vx.x.x build xxxxxx	XX-XXXX-XXXXXXXXXXXXXXXXXXXXXX	Activated	No

- Click the  button to pop up the login dialog box.

Login

Log into the selected device(s):

User Name:

Password:

OK
Cancel

- Enter the user name and password.
- Click the **OK** button to save the settings.

NOTE

- Only devices successfully logged in will be added to the device list for configuration.
- If you add devices in batch, please make sure selected devices have the same user name and password.

7.3.2 Add by IP Address

Purpose:

You can add the device by entering IP address.

Steps:

- Click the  button to pop up the adding devices dialog box.

Device(s) in the list will be configured.

Device List.1
Remote Configurator
Flash rom
Batch Update
Linked Network Batch Configuration
Filter: Device List

Index	Device Type	IP Address	Port	Software Version	Serial No.	Security Status	Configuration Status	Configuration
<input type="checkbox"/>	1	XX-XXXX-XX	10.16.2.8	8000	V x.x.x build xxxxxx	XX-XXXX-XXXXXXXXXXXXXXXXXXXXXX	Strong password	

- Select IP Address in the adding mode drop-down list.
- Enter the IP address, and set the port No., user name and password of the device.

4. Click **OK** to add the device to the device list.



NOTE

- You cannot add the device(s) to the device list if the user name and password are not identical.
- When you add devices by IP Address, IP Segment or Port No., the devices should be online devices.

7.3.3 Add by IP Segment

Purpose:

You can add many devices at once whose IP addresses are among the IP segment.

Steps:

1. Click the button to pop up the adding devices dialog box.

Index	Device Type	IP Address	Port	Software Version	Serial No.	Security Status	Configuration Status	Configuration
<input type="checkbox"/>	1	XX-XXXX-XX	10.16.2.8	8000	V x.x.x build xxxxxx	XX-XXXXXXXXXXXXXXXXXXXXXX	Strong password	

2. Select IP Segment in the adding mode drop-down list.
3. Set the Start IP Address and End IP Address.
4. Enter port No., user name, and password.

5. Click the **OK** button to search and add the devices whose IP addresses are within the range of the defined IP segment to the device list.

7.4 Configure Devices Remotely

In the device list area, select a device and click **Remote Configuration** or to enter the remote configuration interface.

Index	Device Type	IP Address	Port	Software Version	Serial No.	Security Status	Configuration Status	Configuration
1	XX-XXXX-XX	10.16.2.99	8000	Vx.x.x build xxxxxx	XX-XXXX-XXXXXXXXXXXXXX	Weak password		

7.4.1 System

Click **System** on the remote configuration interface to display the device information: Device Information, General, Time, System Maintenance, User, and RS485.

Device Information

Click **Device Information** to enter device basic information interface. You can view basic information (the device type, and serial No.), and version information of the device.

General

Click **General** to enter device general parameters settings interface. You can view and edit the device name and device ID.

Device Information

Device Name:

Device No.:

Time

Steps:

1. Click **Time** to enter the device time settings interface.

Time Zone

Select Time Zone:

Enable NTP

Server Address/Do...:

NTP Port:

Sync Interval: Minute(s)

Enable DST

Start Time: : 00

End Time: : 00

DST Bias:

2. Select Time Zone or Enable NTP.

- **Time Zone**

- 1) Select a time zone from the drop-down list menu.
- 2) Click the **Synchronization** button.

- **NTP**

- 1) Check the checkbox of Enable NTP to enable NTP.
- 2) Enter the server address, NTP port, and synchronization interval.

- **DST**

- 1) Check the checkbox of Enable DST to enable DST.
- 2) Enter the start time and end time of DST, and set the DST bias.

3. Click the **Save** button to save and realize the time settings.



NOTE

The default port No. is 123.

System Maintenance

Purpose:

You can reboot, restore the device, upgrade the device, and change the device system language on the system maintenance interface.

Steps:

1. Click **System Maintenance** to enter the system maintenance interface.

The screenshot shows the 'System Management' interface. It is divided into three main sections:

- System Management:** Contains five buttons: 'Reboot', 'Restore Default Setti...', 'Restore All', 'Import Configuration ...', and 'Export Configuration ...'.
- Remote Upgrade:** Contains a 'Select Type:' dropdown menu with 'Upgrade File' selected, a 'Select File:' text input field with a browse button (...), an 'Upgrade' button, and a 'Progress:' progress bar.
- Language:** Contains a language dropdown menu with 'English' selected and a 'Save' button.

2. Click **Reboot** and the system reboot dialog box pops up. Click **Yes** to reboot the system.
3. Click **Restore Default Settings** to restore the default parameters.
4. Click **Restore All** to restore all parameters of device and reset the device to inactive status.



NOTE

- Click **Restore Default Settings** button, all default settings, excluding network parameters, will be restored.
- Click **Restore All** button, all default settings, including network parameters, will be restored. The device will be reset to inactivated status.

5. Click **Import Configuration File** and the import file window pops up. Select the path of remote configuration files. Click **Open** to import the remote configuration file. The configuration file is imported and the device will reboot automatically.

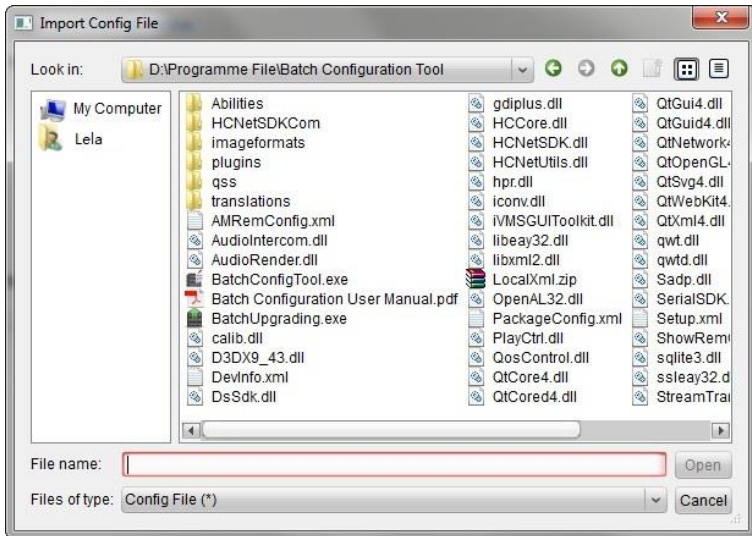

6. Click **Export Configuration File** and the export file window pops up. Select the saving path of remote configuration files and click **Save** to export the configuration file.

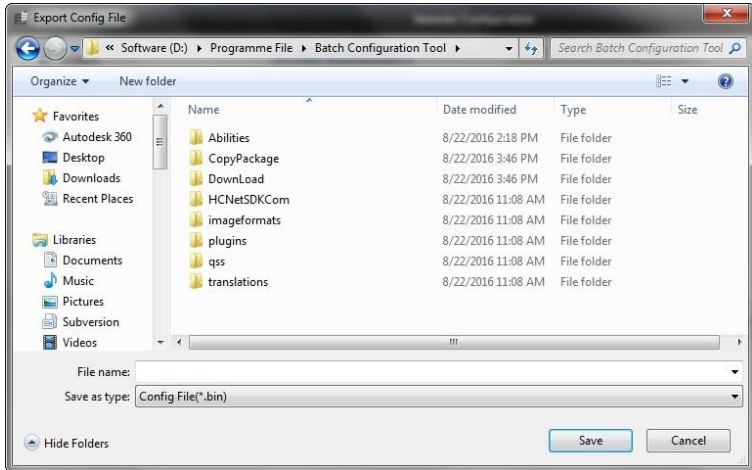

7. Click  to select the upgrade file and click **Upgrade** to remote upgrade the device. The process of remote upgrade will be displayed in the process bar.

Remote Upgrade

Select Type: Upgrade File ▾

Select File: ... Upgrade

Progress:

8. Select a language, and click **Save** to change the device system language.



NOTE

- The device supports 5 languages: English, Russian, French, Portuguese, and Spanish.
- Rebooting the device is required after you change the system language.

User

Purpose:

You can edit the password for logging in the device.

Steps:

1. Click **User** to enter the user information editing interface.

+ Add Modify Delete

User Name	Priority
admin	Administrator

2. Select the user to edit and click **Modify** to enter the user parameter interface.

User Information

User Type: Administrator ▾ User Name: admin

Password: Confirm Password:

IP Address: 0.0.0.0 MAC Address: 00:00:00:00:00:00

User Prission

- Local PTZ Control
- Local Manual Recording
- Local Playback
- Local Parameter Settings
- Local Log Search
- Local Advanced Operation
- Local Parameters View
- Local Camera Management
- Local Video Export
- Local Shutdown / Reboot

Save Cancel

3. Enter the new password, and confirm it.
4. Click **Save** to realize the editing of password.



NOTE

- The new password and confirm password should be identical.
- After editing the password of device, click button from the device list, the added device will not be there. You should add the device again with new password to operate the remote configuration.

RS485

Click **RS485** to enter the RS485 setting interface. You can view and edit the RS485 parameters of the device.

RS485: 1

Bitrate: 9600

Data Bit: 8

Stop Bit: 1

Parity: None

Flow Control: None

Working Mode: Disable

Save



NOTE

For indoor station and master station, there are 3 choices for the working mode: transparent channel, disable, and custom.

7.4.2 Video Intercom

Click **Video Intercom** on the remote configuration interface to enter the video intercom parameters settings: Device Number Configuration, Time Parameters, Password, Zone Configuration, IP Camera Information, and Volume Input and Output Configuration, and so on.

Device ID Configuration

Steps:

1. Click **ID Configuration** to enter device ID configuration interface.

Device No. Configuration

Device Type: Indoor Station

Room No.: 2

Floor No.: 2

Save

Indoor Station

Device No. Configuration

Device Type: Station Extension

Serial No.: 2

Save

Indoor Extension

2. Select the device type from the drop-down list, and set the corresponding information.
3. Click **Save** to enable the device number configuration.

Time Parameters

1. Click **Time Parameters** to enter time parameters settings interface.
2. Configure the maximum ring duration, maximum live view time, and call forwarding time.
3. Click **Save**.

Time Parameters

Device Type: ▼

Max. Ring Duration: s

Max. Live View Duration: s

Call Forwarding Duration: s

Time Parameters



NOTE

- Maximum ring duration is the maximum duration of indoor station when it is called without being received. The range of maximum ring duration varies from 30s to 60s.
- Maximum live view time is the maximum time of playing live view of the indoor station. The range of maximum live view time varies from 10s to 60s.
- Call forwarding time refers to the ring duration limit beyond which the call is automatically forwarded to the mobile phone designated by the resident. The range of call forwarding time varies from 0s to 20s.
- For indoor extension, it only requires setting the maximum live view time.

Password

Click **Password** to enter password changing interface.

For indoor station, you can change the admin password, arm/disarm password, unlock password and duress code.

For indoor extension, only admin password and arm/disarm password need to be configured.

Permission Password

Password Type: Admin Password ▾

Old Password:

New Password:

Confirm Password:

Save

Zone

1. Click the **Zone Alarm** button to enter zone settings interface.

Zone Alarm

Zone No.: 1 ▾

Zone Type: Smoke Detector ▾

Alarm Type: 24-hour Alarm ▾

NO/NC: Normal Open ▾

Entering Delay: 0 s

Exiting Delay: 0 s

Save

2. Select a zone type from the drop-down list menu.
3. Select an alarm mode from the drop-down list menu.
4. Set the zone status: NO or NC.
5. Set the entering delay, and exiting delay.
6. Click the **Save** button to enable zone settings.



NOTE

- 7 zone types are supported: Emergency Switch, Door Magnetic Switch, Smoke Detector, Active IR Detector, Passive IR Detector, Combustible Gas Detector, and DoorBell Switch.
- Three types of alarm mode are supported: Instant Alarm, 24H Alarm, and Delay Alarm.
- When the zone type is set to be Instant Alarm, only under arming mode, the indoor station will receive alarm message when the detector is triggered. Under disarming mode, it will not receive alarm message when the detector is triggered.
- When the zone type is set to be 24H Alarm, the indoor station will receive alarm message when the detector is triggered no matter it is under arming mode or disarming mode.

- When the zone type is set to be Delay Alarm, only under arming mode, the indoor station will receive alarm message when the detector is triggered. Under disarming mode, it will not receive alarm message when the detector is triggered.
- After setting enter delay time, if **OK** is pressed within the enter delay time after the alarm, the alarm event will not be uploaded to the management center; if **OK** is not pressed within the enter delay time after the alarm, the alarm event will be uploaded to the management center.
- The exit delay is the time between you enable the arming mode and the arming takes effect.

IP Camera Information

Purpose:

You can add, delete and modify cameras that can be added to the video intercom products, with two ways of getting stream: direct or URL. By exporting and importing the added device information, you can edit added devices parameters in batch.

Add Camera

Steps:

1. Click **IP Camera Information** to enter IP camera information interface.

IP Camera Information									
Add		Modify		Delete		Export		Import	
Index	Device Name	Getting Stre...	URL	Manufacturer Protocol	User	Password	IP Address		
1	IP Camera	Direct		XXX Protocol	ad...	*****	10.16.7.25		

2. Click **Add** to pop up the device adding dialogue box.
3. Enter corresponding information (device name, IP address, port No., user name, password, etc.), and click **OK**.

 Add IP Camera
×

Device Type:

Getting Stream Mode:

Device Name:

IP Address:

Port:

User Name:

Password:

Camera No.:

Manufacturer Protocol:



Indoor extension does not support this function.

Export and Import Added Device Information

Steps:

1. Click **Export** to export the added device information file.

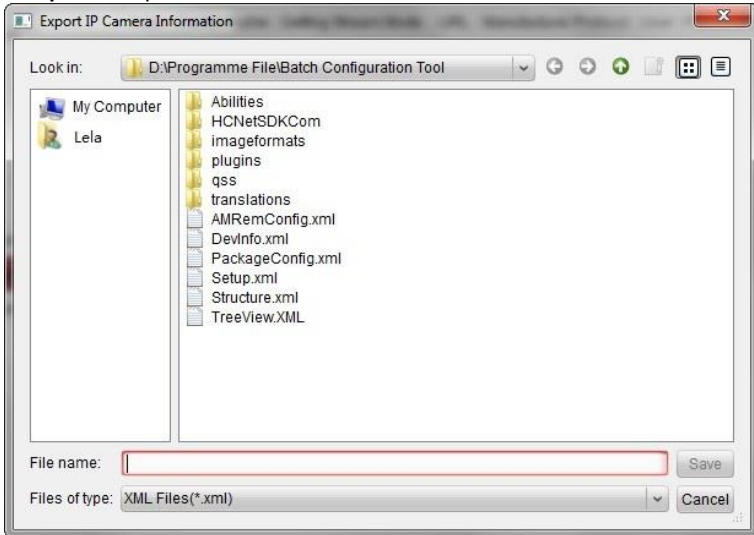

2. Edit parameters of added devices in batch in the exported file.
3. Click **Import** to pop up importing box, and open the edited added device information file.

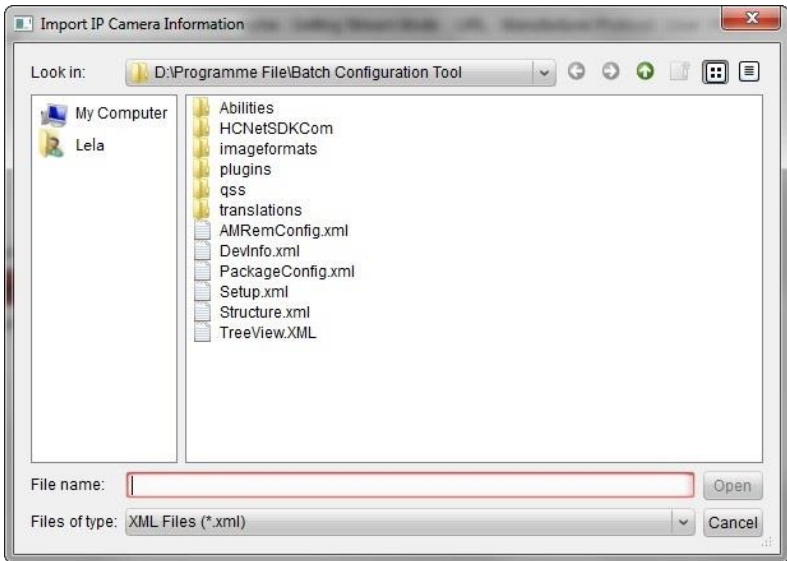

Volume Input and Output

Step:

1. Click **Volume Input/Output** to enter the volume input and output interface.

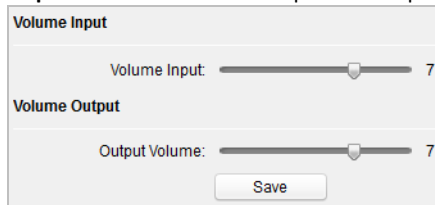

2. Slide the slider to adjust the volume input and volume output.
3. Click **Save** to enable the settings.

Ring Import

Click **Ring Import** to enter the ring configuration interface.

Configure Ring parameters						
No.	Name	Size	Type	Add	Remove	
1	Ring 1	123098	wav	+	×	
2	Ring 2	124324	wav	+	×	
3	Ring 3	123098	wav	+	×	
4	Ring 4	124324	wav	+	×	

Click  to add the ring, and click  to delete the imported ring.



NOTE

- The ring to be imported should be in the wav format, and the size of the ring cannot be larger than 300k.
- Up to 4 rings can be added.

SIP Protocol Settings

Click **Intercom Protocol** to enter the SIP settings interface.

2 types of SIP protocol are available: Private Protocol, and standard SIP protocol.

7.4.3 Network

Local Network Configuration

Steps:

1. Click **Local Network Configuration** to enter local network configuration interface.

2. Enter the local IP address, subnet mask, gateway address, and port No.
3. Click **Save** to enable the settings.



NOTE

- The default port No. is 8000.
- After editing the local network parameters of device, you should add the devices to the device list again.

Linked Devices Network Configuration

Purpose:

In the linked devices network configuration interface, you can configure the network parameters of master stations, SIP servers and management centers of the same LAN. The devices can be linked to the door station and realize the linkage between these devices.

Steps:

1. Click **Linked Network Configuration** to enter linked network configuration interface.

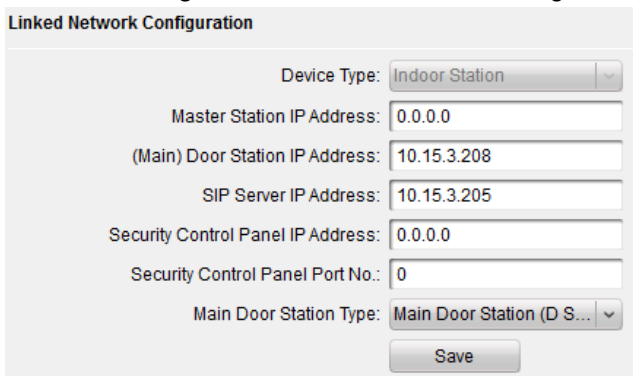

Linked Network Configuration

Device Type: Indoor Station

Master Station IP Address: 0.0.0.0

(Main) Door Station IP Address: 10.15.3.208

SIP Server IP Address: 10.15.3.205

Security Control Panel IP Address: 0.0.0.0

Security Control Panel Port No.: 0

Main Door Station Type: Main Door Station (D S...)

Save

2. Enter the master station IP address, (main) door station IP address, SIP server IP address, management center IP address, and doorphone IP address.
3. Select the main door station type from the drop-down list.
4. Click **Save** to enable the settings.



NOTE

- After adding master station IP Address, the linkage between indoor station and master station can be realized.
- After adding the door station IP Address, the video intercom between indoor stations of same building can be realized.
- After adding SIP Server Address IP, the video intercom of same community: video intercom between indoor stations of different building, calling indoor station from outer door station and video intercom between management center and indoors.
- After adding management center IP Address, the events can be uploaded to the management center.
- For indoor extension, only parameter about the main indoor station should be configured.

DNS Settings

The indoor station supports 2 DNS address.

Click **Advanced Settings** to enter DNS address settings interface.

DNS1 IP Address:

DNS2 IP Address:

7.4.4 Video Display

Click **Video Display** -> **Video Parameters** to adjust the relevant parameters for the video.



NOTE

Only indoor station equipped with a physical camera has the video parameters settings.

Camera No.:

Format:

Brightness:

Hue:

Contrast:

Saturation:

Sharpness:

Noise Reduction:

7.5 Video Intercom Device Set-up Tool

Purpose:

You can assign the device to the community, activate and set the device, and configure the network parameters and linked network parameters for the device by using the video intercom device set-up tool.

In the device list area, click **Flash rom** to enter the video intercom device set-up tool.

Device(s) in the list will be configured.

Index	Device Type	IP Address	Port	Software Version	Serial No.	Security Status	Configuration Status	Configuration
1	XX-XXXX-XX	10.16.2.99	8000	Vx.x.x.build.xxxxxx	XX-XXXX-XXXXXXXXXXXX	Weak password		

7.5.1 Set a Community Structure

Set a community structure in the video intercom device set-up tool first, based on the real community situation, and then assign devices to the community accordingly.

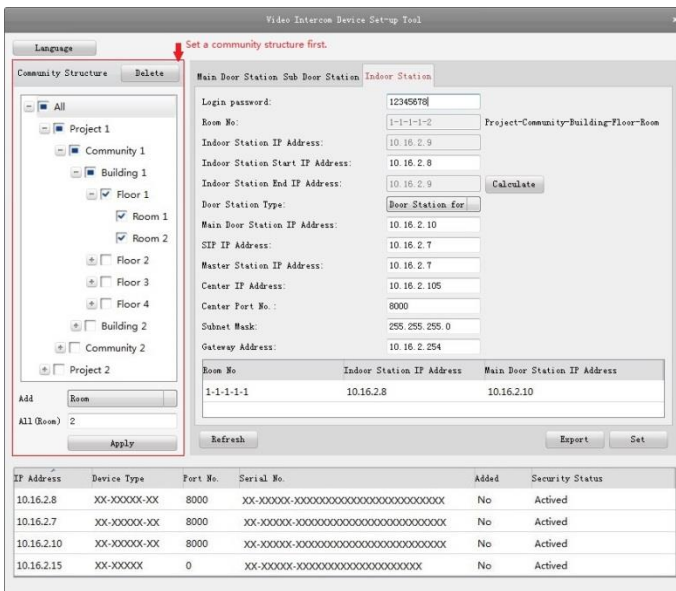

7.5.2 Set Indoor Station

Purpose:

You can activate the online indoor station, and configure the room No. for the online indoor station.

Steps:

1. Press the **Indoor Station** tab to switch to the indoor station configuration interface.

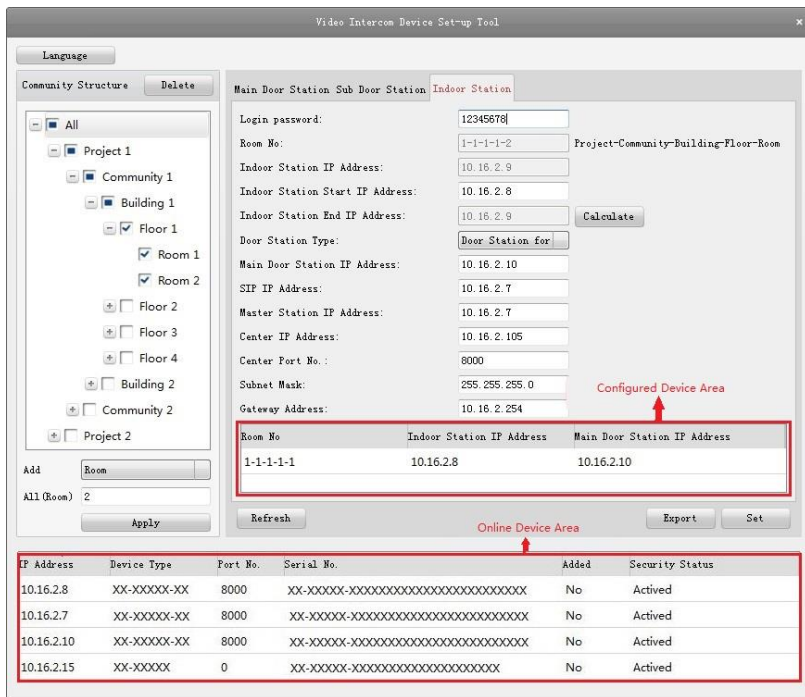

2. Select a community, and enter the indoor station start IP address, and then click the **Calculate** button to generate the indoor station end IP address and indoor station room No. (like 1-1-1-1-2) automatically.
3. Set the main door station parameters: door station type (door station for unit, or door station for villa), main door station IP address.
4. Set the linked network parameters for the indoor station: SIP IP address, master station IP address, center IP address, center port No., subnet mask, and gateway address.
5. Select an online door station, enter the login password, and click the **Set** button.

 **NOTE**

- The indoor station configured successfully will be listed in the configured device area. At the same time, the next indoor station can be easily configured by selecting another indoor station in the online device area and clicking the **Set** button.
- For the login password, if the indoor station has been activated, enter the activation password here. If the indoor station is not activated, create a login password here, and the indoor station will be activated simultaneously.

- When the device is successfully configured, it prompts the note: Configuring main door station parameters succeeded.

7.6 Batch Upgrading

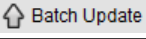
In the device list area, click  to enter the batch upgrading interface.

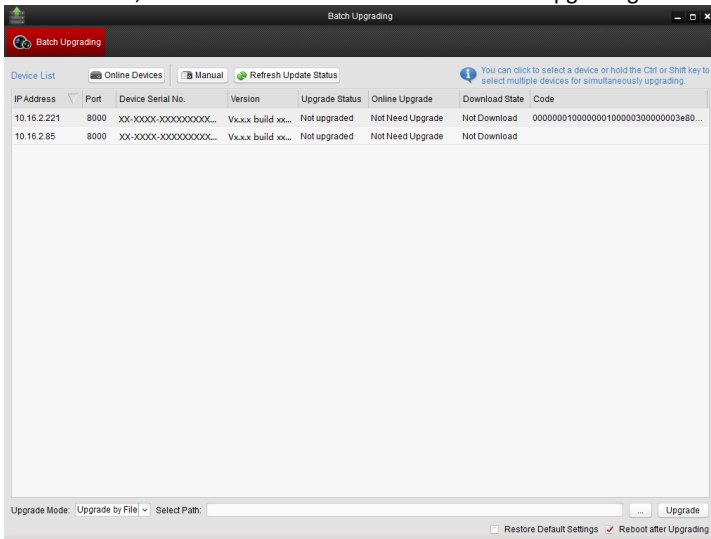

7.6.1 Add Devices for Upgrading

You should add the device to the batch upgrading tool first before upgrading the device. There are 2 ways to add the device: adding online device, and adding by IP address/IP segment.

Add Online Device

Steps:

1. In the batch upgrading interface, click the  to open the online device window.

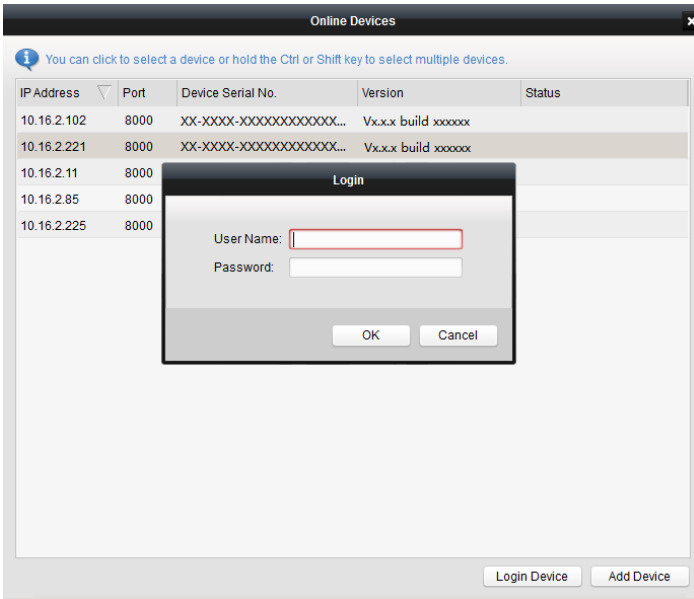

2. Select a device, enter the user name and password, and click the **Login Device** button.
3. Click the **Add Device** button, and the device is added to the batch upgrading tool.

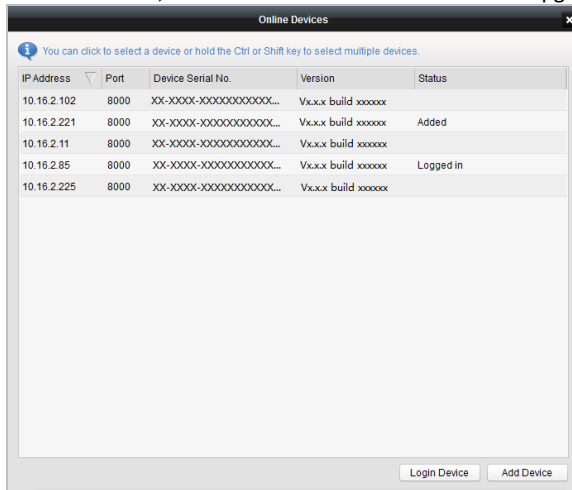

Adding by IP Address/IP Segment

Steps:

1. Click the **Manual** button to open the device adding window.

2. Enter the corresponding information (IP address, user name, password, start IP address, end IP address).
3. Click the **Add** button.

The screenshot shows a 'Search' dialog box with two main sections. The first section, 'By IP', has input fields for IP Address, Port (8000), User Name, and Password, with an 'Add>>' button below. The second section, 'By IP Segment', has input fields for Start IP, End IP, Port (8000), User Name, and Password, also with an 'Add>>' button below. A 'Cancel' button is located at the bottom right of the dialog.

7.6.2 Upgrade by File

You can upgrade indoor stations in batch via the Batch Upgrading tool. The indoor station support Upgrading by File, that is, you can upgrade indoor stations in batch via the local upgrade files.

Steps:

1. Select a device or multiple devices, and select “Upgrade by File” as the upgrading mode.
2. Click  to pop up the window for opening the upgrading file.

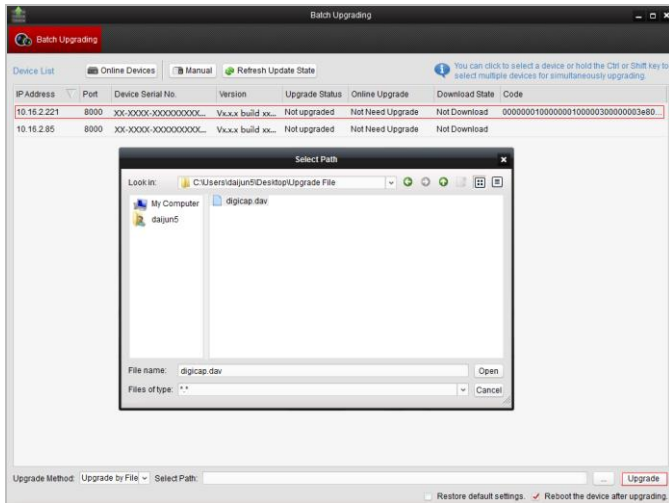

3. Open the upgrading file, and click the **Upgrade** button.

8 Remote Operation via iVMS-4200

The Video Intercom module provides remote control and configuration on video intercom products via the iVMS-4200 client software.

8.1 System Configuration

Purpose:



You can configure the video intercom parameters accordingly.

Steps:

1. Open the System Configuration page.

Path: **Control Panel -> Maintenance and Management -> System Configuration -> Video Intercom.**

2. Click **Video Intercom** to enter the Video Intercom Settings interface.
3. Input the required information.

Ringtone: Click the icon  and select the audio file from the local path for the ringtone of indoor station. Optionally, you can click the icon  for a testing of the audio file.

Max. Ring Duration: Input the maximum duration of the ringtone, ranging from 15 seconds to 60 seconds.

Max. Speaking Duration with Indoor Station: Input the maximum duration of speaking with the indoor station, ranging from 120 seconds to 600 seconds.

Max. Speaking Duration with Door Station: Input the maximum duration of speaking with the door station, ranging from 90 seconds to 120 seconds.

4. Click **Save** to save the settings.

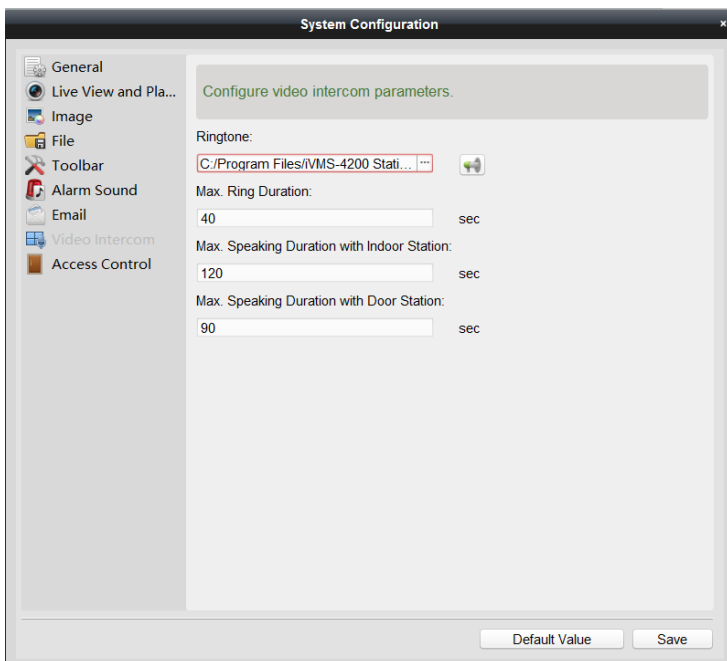

8.2 Device Management

Purpose:

Device management includes device activation, adding device, editing device, and deleting device, and so on.

After running the iVMS-4200, video intercom devices should be added to the client software for remote configuration and management.

8.2.1 Add Video Intercom Devices



NOTE

- You can add at most 512 indoor stations and master stations in total to the iVMS-4200, and add at most 16 door stations to the iVMS-4200.
- For video intercom devices, you are required to create the password to activate them before they can be added to the software and work properly. For device activation via creating password, please refer *User Manual of iVMS-4200 (Video Intercom) V2.4.2* in the disk for detail steps.
- You can add online video intercom devices, and add them manually. Here take adding online video intercom devices as example. For adding video intercom devices

manually, please refer *User Manual of iVMS-4200 (Video Intercom) V2.4.2* in the disk for detail steps.

Steps:



1. Click the  icon on the control panel, or click **Tools->Device Management** to open the Device Management page.
2. Click the **Device** tab.
3. On the Device Type panel on the right, you can select **Hikvision Device** to add video intercom devices.
4. The active online devices in the same local subnet with the client software will be displayed on the **Online Device** area. You can click the **Refresh Every 60s** button to refresh the information of the online devices.

Online Device (5)							Refresh Every 60s
+ Add to Client + Add All <input checked="" type="checkbox"/> Modify Netinfo ↻ Reset Password ⏻ Activate							Filter
IP	Device Type	Firmware Version	Security	Server Port	Start Time	Added	
10.16.2.11	XX-XXXX-XX	Vx.x.x build xxxxxx	Active	8000	2016-07-05 09:21:55	No	
10.16.2.85	XX-XXXX-XX	Vx.x.x build xxxxxx	Active	8000	2019-01-21 21:43:24	Yes	
10.16.2.102	XX-XXXX-XX	Vx.x.x build xxxxxx	Active	8000	2016-07-05 09:33:52	No	

 **NOTE**

To add online devices to the software, you are required to change the device IP address to the same subnet with your computer first.

5. Select the devices to be added from the list.
6. Click **Add to Client** to open the device adding dialog box.
7. Input the required information.

Nickname: Edit a name for the device as you want.

Address: Input the device’s IP address. The IP address of the device is obtained automatically in this adding mode.

Port: Input the device port No. The default value is 8000.

User Name: Input the device user name. By default, the user name is admin.

Password: Input the device password. By default, the password is **12345**.

8. Optionally, you can check the checkbox **Export to Group** to create a group by the device name. All the channels of the device will be imported to the corresponding group by default.

 **NOTE**

iVMS-4200 also provides a method to add the offline devices. Check the checkbox **Add Offline Device**, input the required information and the device channel number and alarm input number, and then click **Add**. When the offline device comes online, the software will connect it automatically.

9. Click **Add** to add the device.

Add

Adding Mode:

IP/Domain IP Segment Hik-Connect... EHome Serial Port

IP Server HiDDNS Batch Import

Add Offline Device

Nickname: Video Intercom Device

Address: 10.7.112.122

Port: 8000

User Name: admin

Password: ●●●●●●

Export to Group

Set the device name as the group name and add all the channels connected to the device to the group.

Add Cancel

**NOTE****Add Multiple Online Devices**

If you want to add multiple online devices to the client software, click and hold Ctrl key to select multiple devices, and click **Add to Client** to open the device adding dialog box. In the pop-up message box, enter the user name and password for the devices to be added.

Add All the Online Devices

If you want to add all the online devices to the client software, click Add All and click **OK** in the pop-up message box. Then enter the user name and password for the devices to be added.

8.2.2 Modify Network Information

Select the device from the online list, click **Modify Netinfo**, and then you can modify the network information of the selected device.

Modify Network Parameter

Device Information:

MAC Address: 3c-52-82-33-c8-d7

Software Version: \

Device Serial No.: D

Network Information:

Port: 8000

Save IPv4 Settings

IP Address: 10.6.113.15

Subnet Mask: 255.255.255.0

Gateway:

Password:

**NOTE**

You should enter the admin password of the device in the **Password** field of the pop-up window to modify the parameters.

8.2.3 Reset Password

According to the different video intercom devices, the software provides two different methods for restoring the default password or resetting the password.

Select the device from the online device list, click **Reset Password**.

Option 1:

If the window with import file button, key importing mode drop-down list, password and confirm password field pops up, follow the steps below to reset the password:

**NOTE**

This option is available to door stations.

1. Click **Export** to save the device file on your computer.
2. Send the file to our technical engineers.
3. Our technical engineer will send you a file to you. After receiving a file from the technical engineer, select **Import File** from Key Importing Mode drop-down list and click  to import the file.
4. Input new password in text fields of **Password** and **Confirm Password**.
5. Click **OK** to reset the password.

STRONG PASSWORD RECOMMENDED– *We highly recommend you create a strong password of your own choosing (Using a minimum of 8 characters, including at least three of the following categories: upper case letters, lower case letters, numbers, and special characters.) in order to increase the security of your product. And we recommend you reset your password regularly, especially in the high security system, resetting the password monthly or weekly can better protect your product.*



Option 2:

If the window with import file and export file buttons, password and confirm password field pops up, follow the steps below to reset the password:



NOTE

This option is available to indoor stations and master stations.

Reset Password ✕

Export File:

Import File:

Password:

Valid password range [8-16]. You can use a combination of numbers, lowercase, uppercase and special character for your password with at least two kinds of them contained.

Confirm Passw...

1. Click **Export** to save the device file on your computer.
2. Send the file to our technical engineers.
3. Click **Import** and select the file received from the technical engineer.
4. Input new password in text fields of **Password** and **Confirm Password**.
5. Click **OK** to reset the password.

STRONG PASSWORD RECOMMENDED— *We highly recommend you create a strong password of your own choosing (Using a minimum of 8 characters, including at least three of the following categories: upper case letters, lower case letters, numbers, and special characters.) in order to increase the security of your product. And we recommend you reset your password regularly, especially in the high security system, resetting the password monthly or weekly can better protect your product.*



8.3 Remote Configuration

Configuring devices remotely via iVMS-4200 is the same with that via Batch Configuration Tool, please refer 7.4 *Configure Devices Remotely* for detail steps.

8.4 Person and Card Management

Purpose:

You can add, edit, and delete the organization and person in Person and Card Management module. Organization and person management is necessary for the video intercom function.

Before you start:

For the first time opening the Access Control module, the following dialog will pop up and you are required to select the scene according to the actual needs.

You can select the scene as **Non-residence** and **Residence**.

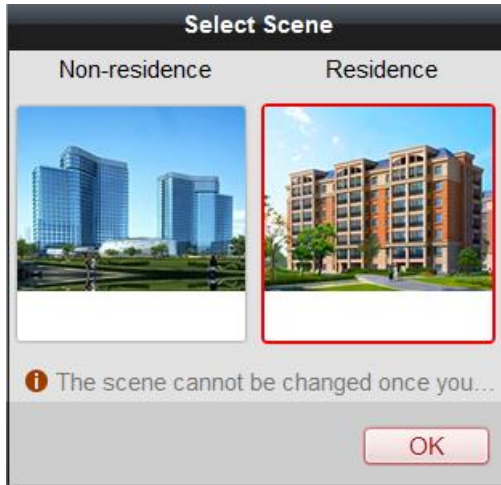

NOTE

Once the scene is configured, you cannot change it later.



Click  ->  tab to enter the Person and Card Management interface.

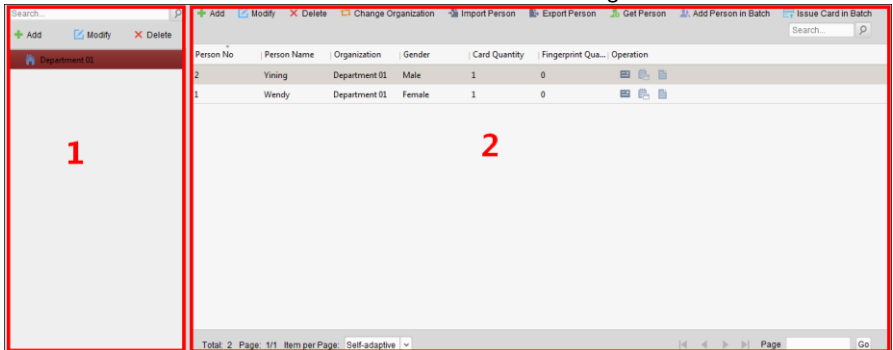

The interface is divided into two parts: Organization Management and Person Management.

1	Organization Management	You can add, edit, or delete the organization as desired.
2	Person Management	After adding the organization, you can add the

		person to the organization and issue card to persons for further management.
--	--	--

8.4.1 Organization Management

Add Organization

Steps:

1. In the organization list on the left, you should add a top organization as the parent organization of all organizations.

Click **Add** button to pop up the adding organization interface.

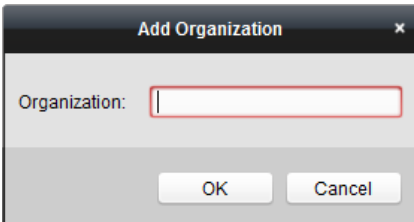

2. Input the Organization Name as desired.
3. Click **OK** to save the adding.
4. You can add multiple levels of organizations according to the actual needs.

To add sub organizations, select the parent organization and click **Add**.

Repeat *Step 2* and *3* to add the sub organization.

Then the added organization will be the sub-organization of the upper-level organization.



NOTE

Up to 10 levels of organizations can be created.

Modify and Delete Organization

You can select the added organization and click **Modify** to modify its name.

You can select an organization, and click **Delete** button to delete it.



NOTE

- The lower-level organizations will be deleted as well if you delete an organization.
- Make sure there is no person added under the organization, or the organization cannot be deleted.

8.4.2 Person Management

After adding the organization, you can add person to the organization and manage the added person such as issuing cards in batch, importing and exporting person's information in batch, etc.



NOTE

Up to 10,000 persons or cards can be added.

Add Person

Person information is necessary for the video intercom system. And when you set linked device for the person, the intercom between intercom devices can be realized.

Steps:

1. Select an organization in the organization list and click **Add** on the Person panel to pop up the adding person dialog.



NOTE

The Person No. will be generated automatically and is not editable.

Add Person
x

Person No.:	<input type="text" value="2"/>	*	
Person Name:	<input type="text"/>	*	
Gender:	<input checked="" type="radio"/> Male <input type="radio"/> Female	*	
Phone No.:	<input type="text"/>		
Date of Birth:	<input type="text" value="2017-01-18"/>		
Place of Birth:	<input type="text"/>		
Email:	<input type="text"/>		<input type="button" value="Upload Picture"/> <input type="button" value="Take Photo"/>

Details
 Permission
 Card
 Fingerprint
 Attendance Rule

ID Type:	<input type="text" value="ID"/>	Country:	<input type="text"/>
ID No.:	<input type="text"/>	City:	<input type="text"/>
Job Title:	<input type="text"/>	Degree:	<input type="text" value="Junior High School Diploma"/>
On Board Date:	<input type="text" value="2017-01-18"/>	Employment Duration:	<input type="text" value="10"/>
Linked Device:	<input type="text"/>		
Room No.:	<input type="text"/>		
Address:	<input type="text"/>		
Remark:	<input type="text"/>		

2. Set basic person information.
 - 1) Enter basic information: person name, gender, phone No., birthday details, and email address.
 - 2) (Optional) Click **Upload Picture** to select the person picture from the local PC to upload it to the client.



NOTE

The picture should be in *.jpg format.

- 3) (Optional) You can also click **Take Phone** to take the person's photo with the PC camera.
3. Set linked device for the person.
 - 1) Click **Details**.

Details		Permission	Card	Fingerprint	Attendance Rule
ID Type:	ID	Country:			
ID No.:		City:			
Job Title:		Degree:		Junior High School Diploma	
On Board Date:	2017-01-18	Employment Duration:	10		
Linked Device:					
Room No.:					
Address:					
Remark					

- 2) Set the linked devices
 - **Linked Device:** You can bind the indoor station to the person.



NOTE

If you select **Analog Indoor Station** in the Linked Device, the **Door Station** field will display and you are required to select the door station to communicate with the analog indoor station.

- **Room No.:** You can enter the room No. of the person.

- 3) Click **OK** to save the settings.
4. Issue the card for the person.
 - 1) Click **Card**.

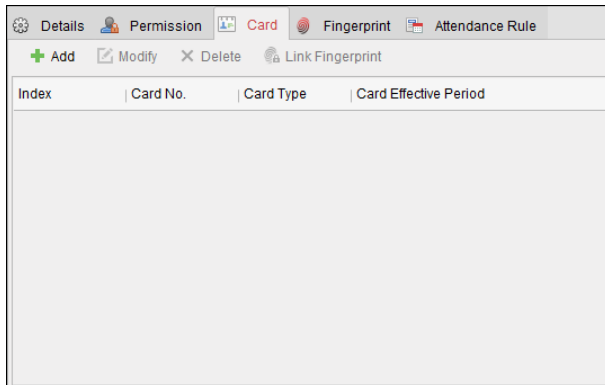

- 2) Click **Add** to pop up the Add Card dialog.

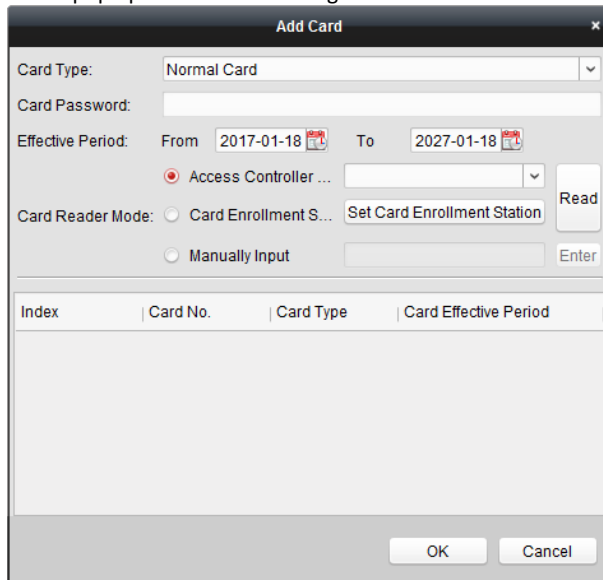

- 3) Select **Normal Card**.
- 4) Enter the password of the card itself in the Card Password field. The card password should contain 4 to 8 digits.
- 5) Enter Card Number manually.
- 6) Click **OK** and the card(s) will be issued to the person.

Import and Export Person Information

The person information can be imported and exported in batch.

Steps:

1. **Exporting Person:** You can export the added persons' information in Excel format to the local PC.
 - 1) After adding the person, you can click **Export Person** button to pop up the following dialog.
 - 2) Click  to select the path of saving the exported Excel file.
 - 3) Check the checkboxes to select the person information to export.

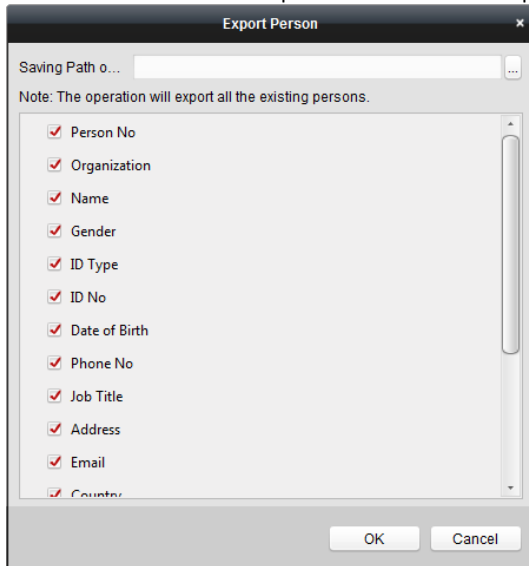

- 4) Click **OK** to start exporting.
2. **Importing Person:** You can import the Excel file with persons information in batch from the local PC
 - 1) click **Import Person** button.

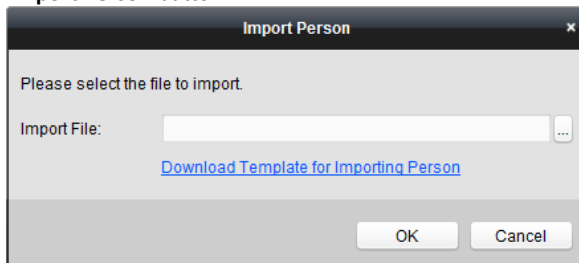

- 2) You can click **Download Template for Importing Person** to download the template first.
- 3) Input the person information to the downloaded template.
- 4) Click  to select the Excel file with person information.

- 5) Click **OK** to start importing.

Get Person Information from Device

If the added device has been configured with person information (including person details, fingerprint, issued card information), you can get the person information from the device and import to the client for further operation.



NOTE

This function is only supported by the device the connection method of which is TCP/IP when adding the device.

Steps:

1. In the organization list on the left, click to select an organization to import the persons.
2. Click **Get Person** to pop up the following dialog box.

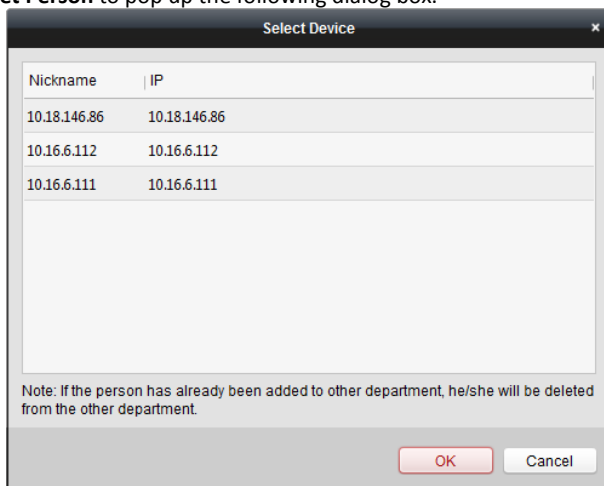

3. The added access control device will be displayed.
4. Click to select the device and then click **OK** to start getting the person information from the device.



You can also double click the device name to start getting the person information.



NOTE

- The person information, including person details, person's fingerprint information (if configured), and the linked card (if configured), will be imported to the selected organization.
- If the person name stored in the device is empty, the person name will be filled with the issued card No. after importing to the client.
- The gender of the persons will be **Male** by default.

Modify and Delete Person

To modify the person information and attendance rule, click  or  in the Operation column, or select the person and click **Modify** to open the editing person dialog.

You can click  to view the person's card swiping records.

To delete the person, select a person and click **Delete** to delete it.



NOTE

If a card is issued to the current person, the linkage will be invalid after the person is deleted.

Change Person to Other Organization

You can move the person to another organization if needed.

Steps:

1. Select the person in the list and click **Change Organization** button.

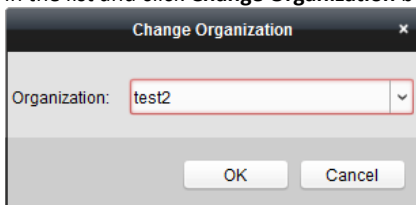

2. Select the organization to move the person to.
3. Click **OK** to save the settings.

Issue Card in Batch

You can issue multiple cards for the person with no card issued in batch.

Steps:

1. Click **Issue Card in Batch** to enter the following dialog.
All the added person with no card issued will display in the Person(s) with No Card Issued list.

2. Select **Normal Card**.
3. Enter the password of the card itself in the Card Password field. The card password should contain 4 to 8 digits.
4. Enter the card quantity issued for each person.
For example, if the Card Quantity is 3, you can read or enter three card No. for each person.
5. Click  to set the effective time and expiry time of the card.
6. Set the card No.
7. After issuing the card to the person, the person and card information will display in the Person(s) with Card Issued list.
8. Click **OK** to save the settings.

8.5 Video Intercom

Purpose:

The Video Intercom Management module provides the function of video intercom, checking call logs and managing notice via the iVMS-4200 client software.





NOTE

For the user with access control module permissions, the user can enter the Access Control module and manage video intercom and search information.

Before you start:

Before you can remote control the video intercom, you should add the device to the software and configure the person to link the device in the Access Control module.

Click  ->  tab on the left icon bar to enter the Video Intercom interface.

8.5.1 Call Indoor Station via iVMS-4200

Steps:

1. Click  tab on the left icon bar to enter the Video Intercom interface.

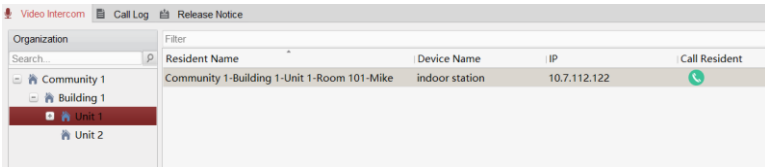

2. Select a resident and click the icon  in the Call Household column to start calling the selected resident.

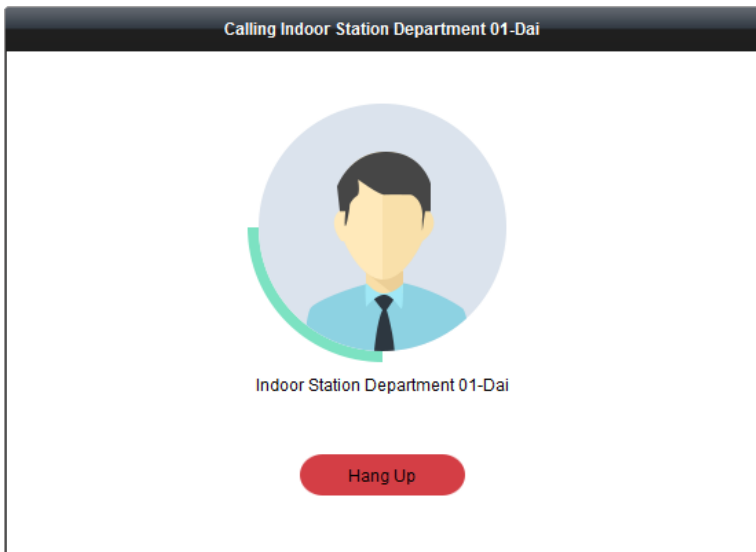

After answered, you will enter the In Call window.

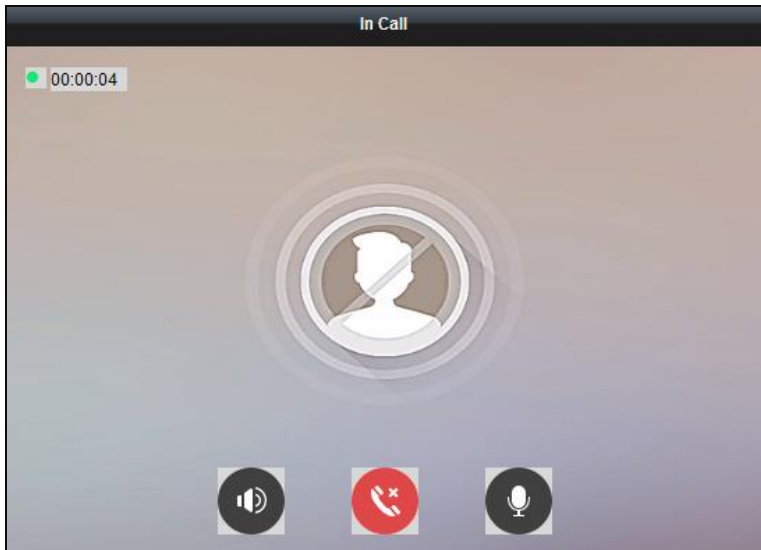

Click  to adjust the volume of the loudspeaker.

Click  to hang up.

Click  to adjust the volume of the microphone.



NOTE

- One indoor station can only connect with one client software.
- You can set the maximum ring duration ranging from 15s to 60s, and the maximum speaking duration ranging from 120s to 600s via the Remote Configuration of indoor station.

8.5.2 Receive Call from Indoor Station/Door Station

Steps:

1. Select the client software in the indoor station or door station interface to start calling the iVMS-4200 and an incoming call dialog will pop up in the client software.

Here we take the **indoor station** as an example.

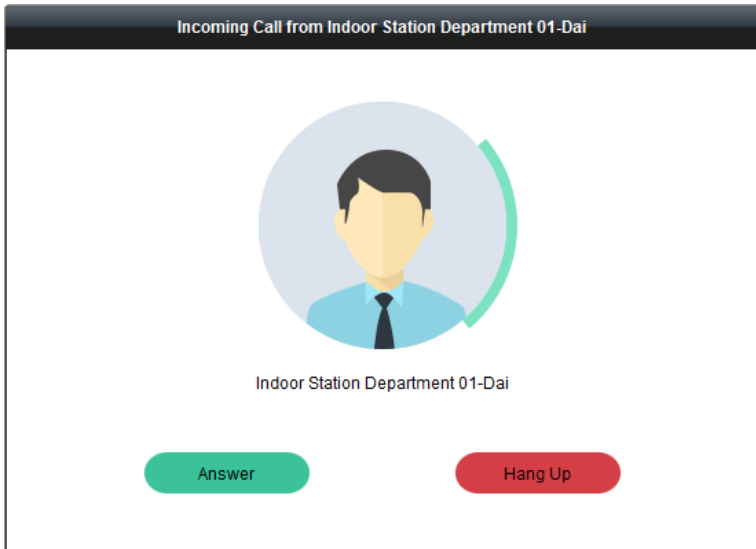

2. Click **Answer** to answer the call.
Or click **Hang Up** to decline the call.
3. After you answer the call, you will enter the In Call window.

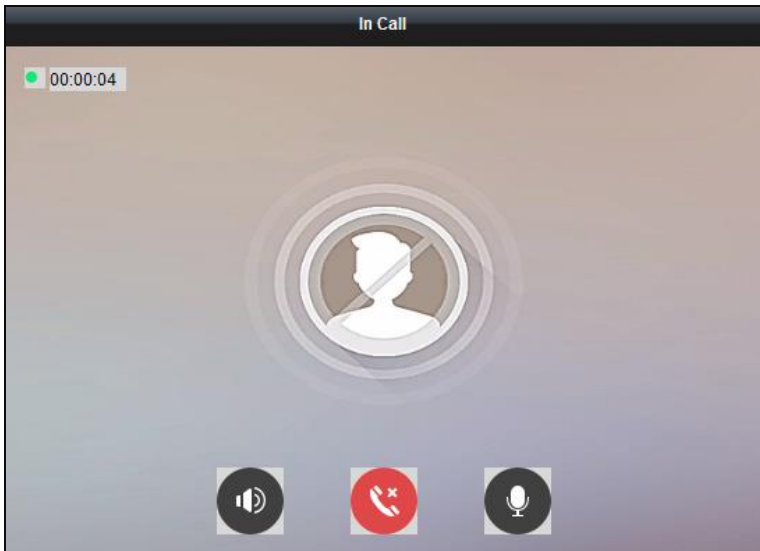

Click  to adjust the volume of the loudspeaker.

Click  to hang up.

Click  to adjust the volume of the microphone.

For door station, you can click  to open the door remotely.



NOTE

- One video intercom device can only connect with one client software.
- The maximum ring duration can be set from 15s to 60s via the Remote Configuration of the video intercom device.
- The maximum speaking duration between indoor station and iVMS-4200 can be set from 120s to 600s via the Remote Configuration of indoor station.
- The maximum speaking duration between door station and iVMS-4200 can be set from 90s to 120s via the Remote Configuration of door station.

8.5.3 View Live Video of Door Station and Outer Door Station

Purpose:

You can get the live view of the door station and outer door station in the Main View module and control the door station and outer door station remotely.

In the Main View module, double-click a door station or outer door station device or drag the device to a display window to start the live view.



You can click **Unlock** on the menu to open the door remotely.

8.5.4 View Call Logs



Purpose:

You can check all the call logs, including dialed call logs, received call logs and missed call logs. You can also directly dial via the log list and clear the logs.

Steps:

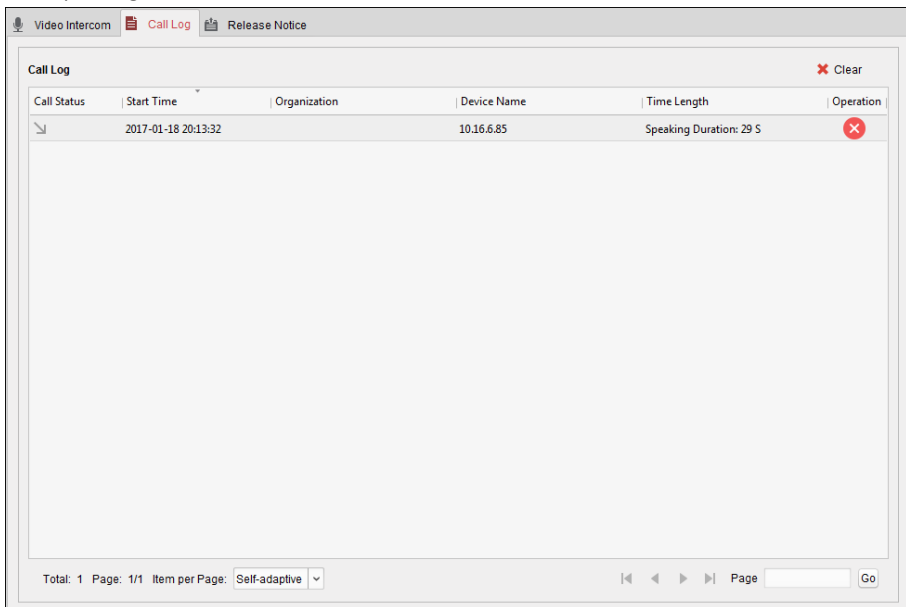
1. In the Video Intercom page, click the **Call Log** tab to enter the Call Log page.
All the call logs will display on this page and you can check the log information, e.g., call status, start time, resident’s organization and name, device name and ring or speaking duration.



2. (Optional) Click the icon  in the Operation column to re-dial the resident.
3. (Optional) Click the icon  in the Operation column to delete the call log.
Or you can click **Clear** at the upper right corner to clear all the logs.

8.5.5 Release Notice

Purpose:

You can create different types of notices and send them to the residents. Four notice types are available, including Advertising, Property, Alarm and Notice Information.

Steps:

1. In the Video Intercom page, click **Release Notice** to enter the Release Notice page.

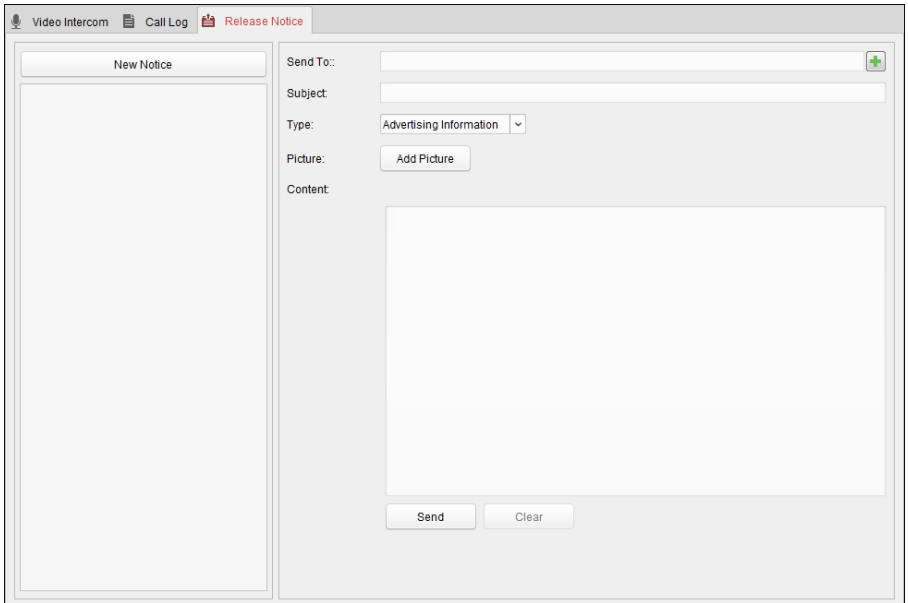

2. Click **New Notice** on the left panel to create a new notice.
3. Edit the notice on the right panel.
 - 1) Click icon  on the Send To field to pop up the Select Resident dialog.

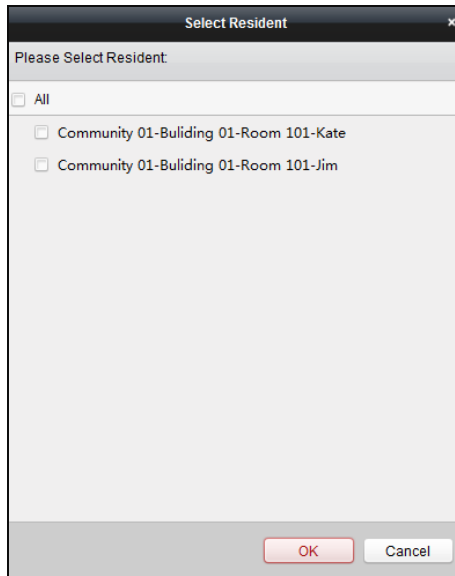

- 2) Check the checkbox(es) to select the resident(s).
Or you can check the **All** checkbox to select all the added residents.
- 3) Click **OK** to save the selection.
- 4) Enter the subject on the Subject field.



NOTE

Up to 63 characters are allowed in the Subject field.

- 5) Click in the Type field to unfold the drop-down list and select the notice type.
- 6) (Optional) Click **Add Picture** to add a local picture to the notice.



NOTE

Up to 6 pictures in the JPGE format can be added to one notice. And the maximum size of one picture is 512KB.

- 7) Enter the notice content in the Content field.
(Optional) You can also click **Clear** to clear the edited content.



NOTE

Up to 1023 characters are allowed in the Content field.

4. Click **Send** to send the edited notice to the selected resident(s).
The sent notice information will display on the left panel. You can click a notice to view the details on the right panel.

8.5.6 Search Video Intercom Information

Purpose:

You can search the call logs between the iVMS-4200 client software and video intercom devices, device unlocking logs and the security notice information.

In the Access Control module, click icon  tab to open the Search page.

Search Call Logs

Steps:

1. In the Information Search page, click the **Call Log** to enter the Call Log interface.

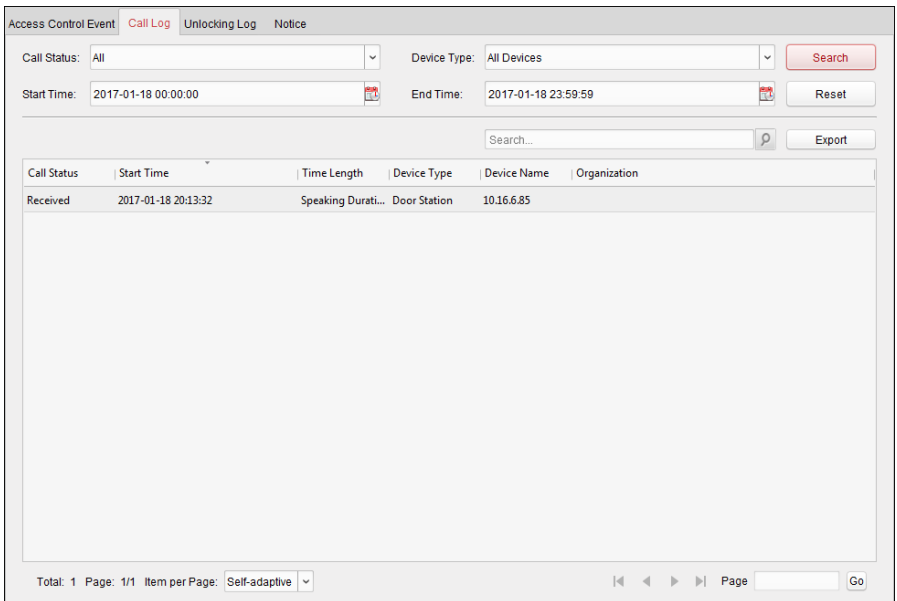

Access Control Event **Call Log** Unlocking Log Notice



Call Status: All Device Type: All Devices Search

Start Time: 2017-01-18 00:00:00 End Time: 2017-01-18 23:59:59 Reset

Search... Export

Call Status	Start Time	Time Length	Device Type	Device Name	Organization
Received	2017-01-18 20:13:32	Speaking Durati...	Door Station	10.16.6.85	

Total: 1 Page: 1/1 Item per Page: Self-adaptive < > Page Go

2. Set the search conditions, including call status, device type, start time and end time.
 - **Call Status:** Click  to unfold the drop-down list and select the call status as **Dialed**, **Received** or **Missed**. Or select **All** to search logs with all statuses.
 - **Device Type:** Click  to unfold the drop-down list and select the device type as **Indoor Station**, **Door Station**, **Outer Door Station** or **Analog Indoor Station**. Or select **All Devices** to search logs with all device types.
 - **Start Time/End Time:** Click  to specify the start time and end time of a time period to search the logs.
(Optional) You can click **Reset** to reset all the configured search conditions.

- Click **Search** and all the matched call logs will display on this page.

For the search results,

- (Optional) Check the detailed information of searched call logs, such as call status, ring/speaking duration, device name, resident organization, etc.
- (Optional) Input keywords in the Search field to filter the desired log.
- (Optional) Click **Export** to export the call logs to your PC.

Search Unlocking Logs

Steps:

- In the Information Search page, click **Unlocking Log** tab to enter the Unlocking Log interface.

The screenshot displays the 'Unlocking Log' search interface. At the top, there are tabs for 'Access Control Event', 'Call Log', 'Unlocking Log', and 'Notice'. The 'Unlocking Log' tab is active. Below the tabs, there is a search form with the following fields and controls:

- Unlocking Type:** A dropdown menu currently set to 'All'.
- Device Type:** A dropdown menu currently set to 'All Devices'.
- Start Time:** A date and time input field showing '2017-01-18 00:00:00'.
- End Time:** A date and time input field showing '2017-01-18 23:59:59'.
- Buttons:** A red 'Search' button, a 'Reset' button, and an 'Export' button.
- Search Field:** A text input field with a magnifying glass icon and an 'Export' button.

Below the search form is a table with the following columns: 'Time', 'Unlocking Type', 'Device Type', 'Card No./Devic...', and 'Capture'. The table is currently empty. At the bottom of the interface, there is a status bar showing 'Total: 0 Page: 1/1 Item per Page: Self-adaptive' and navigation controls including arrows and a 'Page' field with a 'Go' button.

- Set the search conditions, including unlocking type, device type, start time and end time.
 - **Unlocking Type:** Click to unfold the drop-down list and select the unlocking type as **Unlock by Password**, **Unlock by Duress**, **Unlock by Card**, **Unlock by Resident** or **Unlock by Center**. Or select **All** to search logs with all unlocking types.
 - **Device Type:** Click to unfold the drop-down list and select the device type as **Door Station** or **Door Station (V Series)**. Or select **All Devices** to search logs with all device types.

- **Start Time/End Time:** Click  to specify the start time and end time of a time period to search the logs.
3. (Optional) You can click **Reset** to reset all the configured search conditions.
 4. Click **Search** and all the matched unlocking logs will display on this page.

For the searching results,

- (Optional) Check the detailed information of searched unlocking logs, such as unlocked time, card No., device No., etc.
- (Optional) Input keywords in the Search field to filter the searching result.
- (Optional) Click  in the Capture column to view the captured pictures.



NOTE

Viewing captured picture should be supported by device.



- (Optional) Click **Export** to export the unlocking logs to your PC.

Search Notice

Steps:

1. In the Information Search page, click the **Notice** tab to enter the Notice interface.

2. Set the search conditions, including notice type, subject, recipient, start time and end time.

- **Notice Type:** Click  to unfold the drop-down list and select the notice type as **Advertising Information, Property Information, Alarm Information** or **Notice Information**. Or select **All** to search notices with all types.
 - **Subject:** Input the keywords in the Subject field to search the matched notice.
 - **Recipient:** Input the recipient information in the Recipient field to search the specified notice.
 - **Start Time/End Time:** Click  to specify the start time and end time of a time period to search the notices.
(Optional) You can click **Reset** to reset all the configured search conditions.
3. Click **Search** and all the matched notices will display on this page.
- For the searching results,
- (Optional) Check the detailed information of searched notices, such as sending time, sending status, etc.
 - (Optional) Input keywords in the Search field to filter the searching result.
 - (Optional) Click  in the Operation column to pop up Notice Details dialog.

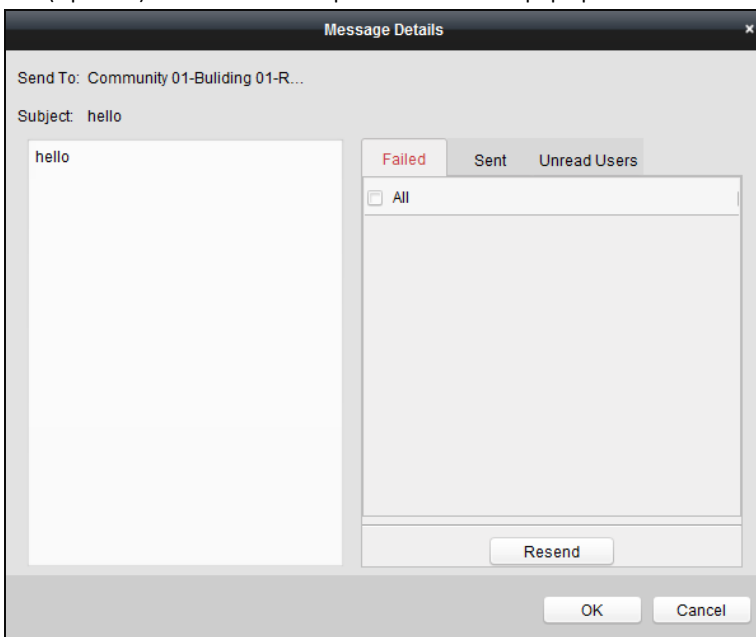

- 4. You can view and edit the notice details, check the sending failed/sent succeeded/unread users, and resend the notice to sending failed/unread users.
- 5. (Optional) Click **Export** to export the notices to your PC.

9 Accessing via Hik-Connect Mobile Client Software

NOTE

- The Hik-Connect mobile client software supports the iOS system and Android system both.
- The basic operations of the client software are similar on the iOS system and on the Android system. Here we take operations on the iOS system as example.

9.1 Install Software

9.1.1 Install Software (iOS)

Steps:



1. Log in the **App Store**.
2. Enter the key words **Hik-Connect** to search the mobile client software.
3. Download and install the software to your iPhone.
4. After installing the software, tap  to run it.

9.1.2 Install Software (Android)

Step:

1. Log onto the **Google Play**.
2. Enter the key words **Hik-Connect** to search the mobile client software.
3. Download and install the software to your phone.
4. After installing the software, tap  to run it.

NOTE

To uninstall the software, tap and hold the software icon  until the icon turns  to , and tap the **delete** icon on the upper-left corner to delete the software.

9.2 Register Software

Purpose:

You should register the software first before logging in the software.

Two ways of registration are available: Registration via Telephone No., and Registration via E-Mail Address. Here we take Registration via Telephone No. as example to introduce registering an account in the software.

Steps:

1. Tap the icon  to run the software, and tap **Register an Account** to enter registration mode selection interface.

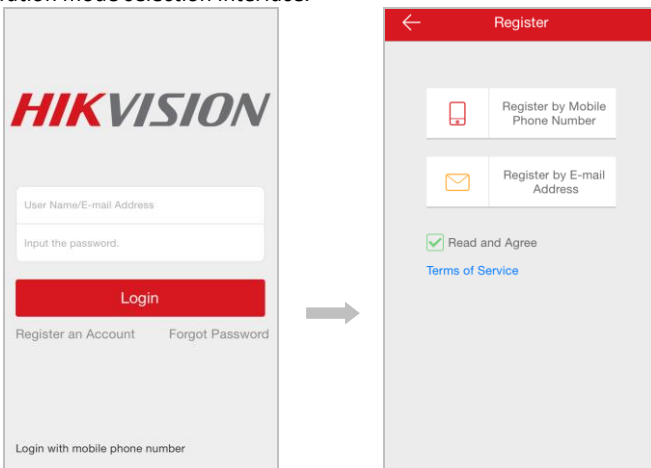

2. Tap **Terms of Service**, and check the checkbox of **Read and Agree** if you agree the Agreement.

3. Tap **Register by Mobile Phone Number**, to enter the region selection interface.

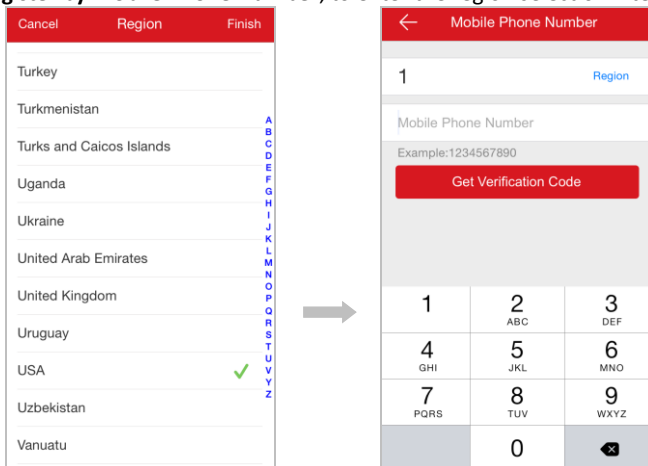

4. Select a target region, enter a valid mobile phone No., and tap the **Get Verification Code** button. The verification code will be sent to your phone.

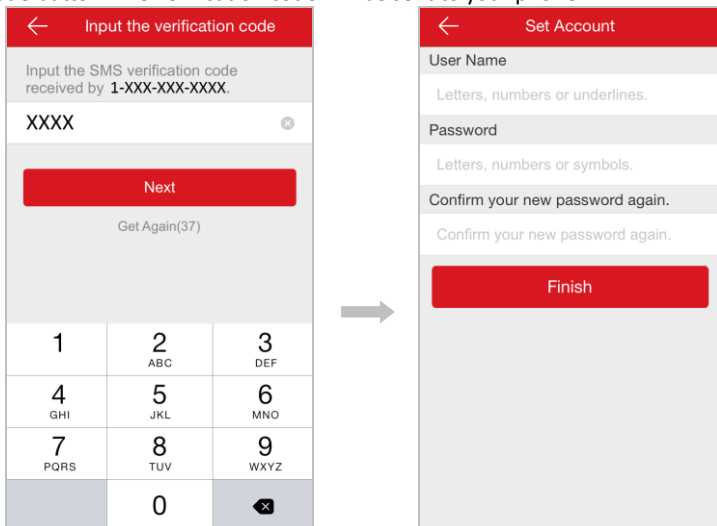

5. Enter the received verification code, and tap the **Next** button to enter the account creating interface. On the account creating interface, enter a user name, a password, a confirm password, and tap the **Finish** button to complete account registration.

9.3 Log in Software

Steps:

1. Tap the icon  to run the software.
2. Enter the user name/e-mail address, and enter the password.
3. Tap the **Login** button to log in the software.

NOTE

- If you want to login via mobile phone No., please tap **Login with mobile phone number**.
- If you forget the password, please tap **Forgot Password** to find the password.

9.4 Add Device

Two ways of adding device are available: Adding Device by Scanning QR Code, and Adding Device by Inputting Device Serial No.

9.4.1 Add Device via QR Code

Steps:

1. On the Home screen, tap the icon .
2. Scan the device QR code to pop up the device information page, and tap the **Add** button.

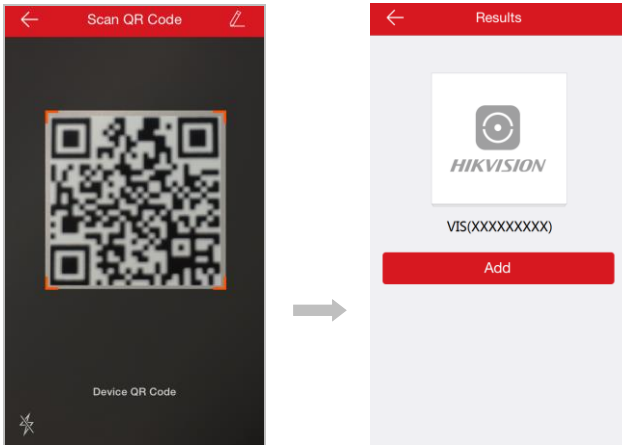

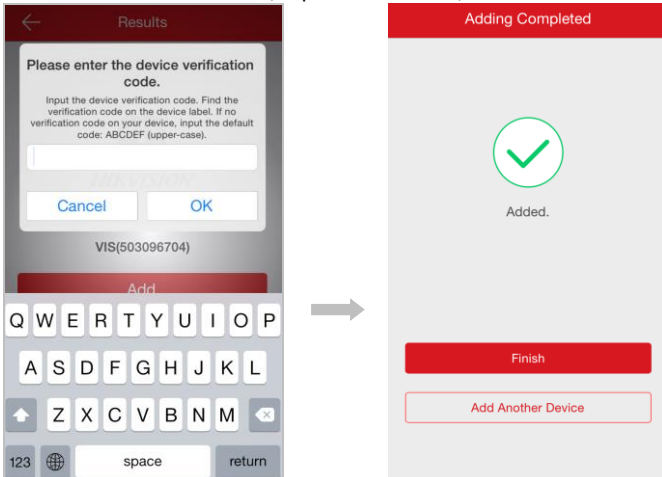

3. Enter the device verification code, tap the **OK** button, and finish the device adding.



9.4.2 Add Device via Serial No.

Steps:

1. On the Home screen, tap the icon , and tap the icon .
2. Enter the serial No. of the device to pop up the device information page, and tap the **Add** button.

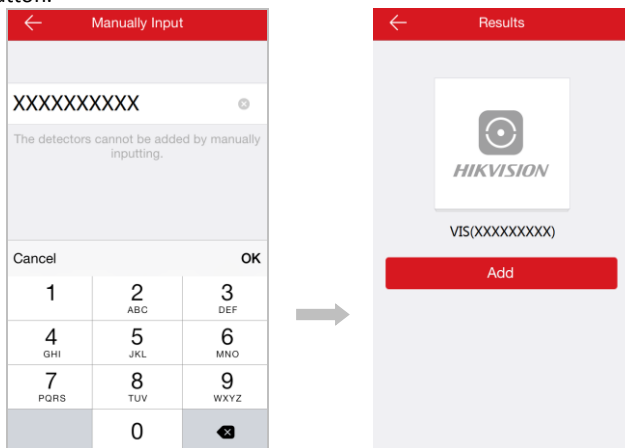

3. Enter the device verification code, tap the **OK** button, and finish the device adding.

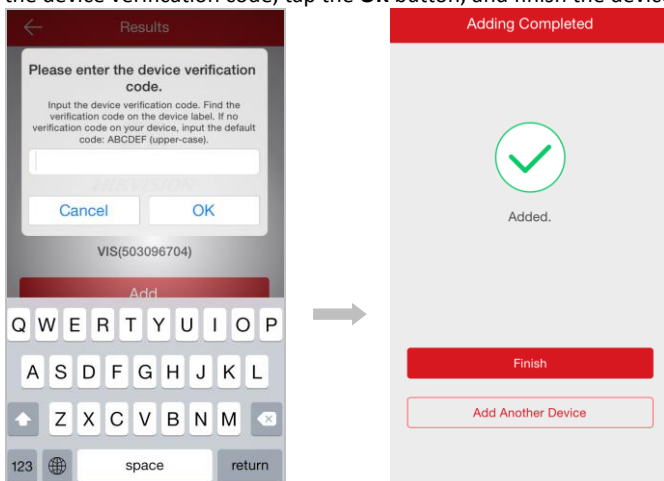

NOTE

- The serial No. of the device is on the label stuck on the rear panel of the device.
- The default device verification code is **ABCDEF**.









9.5 Live View and Remote Unlocking

After adding the device, go the Home page, and tap a camera to enter the live view interface.



On the live view page, you can control the intercom device remotely. See the following table in detail.

Table 9-1 Icon Description

Keys	Description
	Enable the live view.
	Disable the live view.
	Enable/disable the audio.
	Switch to the full-screen mode.
	Switch to the 4-screen mode.
	Zoom in.
	Remote unlock.
	Capture the live view image.
	Enable/disable recording.

Appendix

Installation Notice

While installing the indoor station, please make sure that the distance between any two devices is as far as possible to avoid the howling and echo. The distance between two devices is recommended to be more than 10 meters.



NOTE

Here the devices refer to indoor station, outdoor station and master station.

Wiring Cables

Cable	Specification
Power Cord of Door Station	RVV 2*1.0
Network Cable of Door Station	UTP-five Categories
Door Lock Wiring (With Door Magnetic)	RVV 4*1.0
Door Lock Wiring (Without Door Magnetic)	RVV 2*1.0
Exit Button Wiring	RVV 2*0.5
External Card Reader Wiring	RVVP 4*0.75

