

HIKVISION

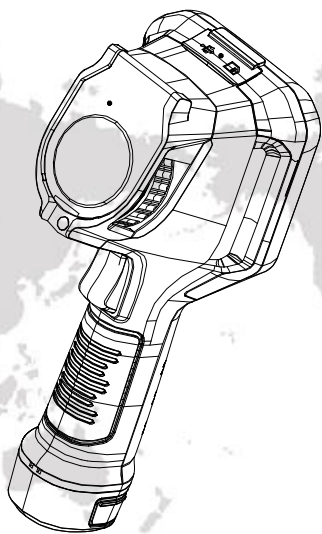

Handheld Thermography Camera

User Manual

COPYRIGHT © 2018 Hikvision. ALL RIGHTS RESERVED

User Manual

COPYRIGHT ©2018 Hangzhou Hikvision Digital Technology Co., Ltd.

ALL RIGHTS RESERVED.

Any and all information, including, among others, wordings, pictures, graphs are the properties of Hangzhou Hikvision Digital Technology Co., Ltd. or its subsidiaries (hereinafter referred to be "Hikvision"). This user manual (hereinafter referred to be "the Manual") cannot be reproduced, changed, translated, or distributed, partially or wholly, by any means, without the prior written permission of Hikvision. Unless otherwise stipulated, Hikvision does not make any warranties, guarantees or representations, express or implied, regarding to the Manual.

About this Manual

This Manual is applicable to **Handheld Thermography Camera**.

The Manual includes instructions for using and managing the product. Pictures, charts, images and all other information hereinafter are for description and explanation only. The information contained in the Manual is subject to change, without notice, due to firmware updates or other reasons.

Please use this user manual under the guidance of professionals.

Trademarks Acknowledgement

HIKVISION and other Hikvision's trademarks and logos are the properties of various jurisdictions. Other trademarks and logos mentioned below are the properties of their respective owners.

Legal Disclaimer

TO THE MAXIMUM EXTENT PERMITTED BY APPLICABLE LAW, THE PRODUCT DESCRIBED, WITH ITS HARDWARE, SOFTWARE AND FIRMWARE, IS PROVIDED "AS IS", WITH ALL FAULTS AND ERRORS, AND HIKVISION MAKES NO WARRANTIES, EXPRESS OR IMPLIED, INCLUDING WITHOUT LIMITATION, MERCHANTABILITY, SATISFACTORY QUALITY, FITNESS FOR A PARTICULAR PURPOSE, AND NON-INFRINGEMENT OF THIRD PARTY. IN NO EVENT WILL HIKVISION, ITS DIRECTORS, OFFICERS, EMPLOYEES, OR AGENTS BE LIABLE TO YOU FOR ANY SPECIAL, CONSEQUENTIAL, INCIDENTAL, OR INDIRECT DAMAGES, INCLUDING, AMONG OTHERS, DAMAGES FOR LOSS OF BUSINESS PROFITS, BUSINESS INTERRUPTION, OR LOSS OF DATA OR DOCUMENTATION,

IN CONNECTION WITH THE USE OF THIS PRODUCT, EVEN IF HIKVISION HAS BEEN ADVISED OF THE POSSIBILITY OF SUCH DAMAGES.

REGARDING TO THE PRODUCT WITH INTERNET ACCESS, THE USE OF PRODUCT SHALL BE WHOLLY AT YOUR OWN RISKS. HIKVISION SHALL NOT TAKE ANY RESPONSIBILITIES FOR ABNORMAL OPERATION, PRIVACY LEAKAGE OR OTHER DAMAGES RESULTING FROM CYBER ATTACK, HACKER ATTACK, VIRUS INSPECTION, OR OTHER INTERNET SECURITY RISKS; HOWEVER, HIKVISION WILL PROVIDE TIMELY TECHNICAL SUPPORT IF REQUIRED.

SURVEILLANCE LAWS VARY BY JURISDICTION. PLEASE CHECK ALL RELEVANT LAWS IN YOUR JURISDICTION BEFORE USING THIS PRODUCT IN ORDER TO ENSURE THAT YOUR USE CONFORMS THE APPLICABLE LAW. HIKVISION SHALL NOT BE LIABLE IN THE EVENT THAT THIS PRODUCT IS USED WITH ILLEGITIMATE PURPOSES.

IN THE EVENT OF ANY CONFLICTS BETWEEN THIS MANUAL AND THE APPLICABLE LAW, THE LATER PREVAILS.

Regulatory Information

FCC Information

Please take attention that changes or modification not expressly approved by the party responsible for compliance could void the user's authority to operate the equipment.

FCC compliance: This equipment has been tested and found to comply with the limits for a Class B digital device, pursuant to part 15 of the FCC Rules. These limits are designed to provide reasonable protection against harmful interference in a residential installation. This equipment generates, uses and can radiate radio frequency energy and, if not installed and used in accordance with the instructions, may cause harmful interference to radio communications. However, there is no guarantee that interference will not occur in a particular installation. If this equipment does cause harmful interference to radio or television reception, which can be determined by turning the equipment off and on, the user is encouraged to try to correct the interference by one or more of the following measures:

- Reorient or relocate the receiving antenna.
- Increase the separation between the equipment and receiver.
- Connect the equipment into an outlet on a circuit different from that to which the receiver is connected.
- Consult the dealer or an experienced radio/TV technician for help.

This equipment should be installed and operated with a minimum distance 20cm between the radiator and your body.

FCC Conditions

This device complies with part 15 of the FCC Rules. Operation is subject to the following two conditions:

1. This device may not cause harmful interference.
2. This device must accept any interference received, including interference that may cause undesired operation

EU Conformity Statement



This product and - if applicable - the supplied accessories too are marked with "CE" and comply therefore with the applicable harmonized European standards listed under the EMC Directive 2014/30/EU, the RoHS Directive 2011/65/EU.



2012/19/EU (WEEE directive): Products marked with this symbol cannot be disposed of as unsorted municipal waste in the European Union. For proper recycling, return this product to your local supplier upon the purchase of equivalent new equipment, or dispose of it at designated collection points. For more information see: www.recyclethis.info.



2006/66/EC (battery directive): This product contains a battery that cannot be disposed of as unsorted municipal waste in the European Union. See the product documentation for specific battery information. The battery is marked with this symbol, which may include lettering to indicate cadmium (Cd), lead (Pb), or mercury (Hg). For proper recycling, return the battery to your supplier or to a designated collection point.

Industry Canada ICES-003 Compliance

This device meets the CAN ICES-3 (B)/NMB-3(B) standards requirements.

This device complies with Industry Canada licence-exempt RSS standard(s). Operation is subject to the following two conditions:

- (1) this device may not cause interference, and
- (2) this device must accept any interference, including interference that may cause undesired operation of the device.

Le présent appareil est conforme aux CNR d'Industrie Canada applicables aux appareils radioexempts de licence. L'exploitation est autorisée aux deux conditions suivantes :

- (1) l'appareil ne doit pas produire de brouillage, et
- (2) l'utilisateur de l'appareil doit accepter tout brouillage radioélectrique subi, même si le brouillage est susceptible d'en compromettre le fonctionnement.

Under Industry Canada regulations, this radio transmitter may only operate using an antenna of a type and maximum (or lesser) gain approved for the transmitter by Industry Canada. To reduce potential radio interference to other users, the

antenna type and its gain should be so chosen that the equivalent isotropically radiated power (e.i.r.p.) is not more than that necessary for successful communication.

Conformément à la réglementation d'Industrie Canada, le présent émetteur radio peut fonctionner avec une antenne d'un type et d'un gain maximal (ou inférieur) approuvé pour l'émetteur par Industrie Canada. Dans le but de réduire les risques de brouillage radioélectrique à l'intention des autres utilisateurs, il faut choisir le type d'antenne et son gain de sorte que la puissance isotrope rayonnée équivalente (p.i.r.e.) ne dépasse pas l'intensité nécessaire à l'établissement d'une communication satisfaisante.

This equipment should be installed and operated with a minimum distance 20cm between the radiator and your body.
Cet équipement doit être installé et utilisé à une distance minimale de 20 cm entre le radiateur et votre corps.



Safety Instruction

These instructions are intended to ensure that user can use the product correctly to avoid danger or property loss.

The precaution measure is divided into **Warnings** and **Cautions**:

Warnings: Neglecting any of the warnings may cause serious injury or death.

Cautions: Neglecting any of the cautions may cause injury or equipment damage.

	
Warnings Follow these safeguards to prevent serious injury or death.	Cautions Follow these precautions to prevent potential injury or material damage.



Warnings

- The device should be used in compliance with local laws and electrical safety regulations. Refer to the appropriate documentation for detailed information.
- The device should be used in the environment within temperature range from -20 °C to 50 °C (-4 °F to 122 °F), and humidity ≤90%
- The input voltage should conform to IEC60825-1 standard: SELV (Safety Extra Low Voltage) and the Limited Power Source ((Input 12 VDC, 1.5A, output 5 VDC, 2A). Refer to the appropriate documentation for detailed information.

- Make sure the plug is properly connected to the power socket.
- If smoke, odor, or noise arises from the device, immediately turn off the power, unplug the power cable, and contact the service center.
- The installer and user are responsible for password and security configuration and its settings.



Cautions

- Do not drop the device or subject it to physical shock.
- Wipe the device gently with a clean cloth and a small quantity of ethanol, if necessary.
- Do not aim the lens at the sun or any other bright light.
- When any laser equipment is in use, make sure that the device lens is not exposed to the laser beam, or it may burn out.
- Do not expose the device to high electromagnetic radiation or extremely hot, cold, dusty, or damp environments.
- Place the device in a dry and well-ventilated environment.
- Keep non-waterproof devices away from liquids.
- Keep the device in original or similar packaging while transporting it.
- A few device components (e.g., electrolytic capacitor) require regular replacement. The average lifespan varies, so periodic checking is recommended. Contact your dealer for details.
- Improper use or replacement of the battery may result in explosion hazard. Replace with the same or equivalent type only. Dispose of used batteries in conformance with the instructions provided by the battery manufacturer.
- Never attempt to disassemble the device.

Safety Instruction



CAUTION: THE PRODUCT IS BUILT IN A REPLACEABLE BATTERY. RISK OF EXPLOSION IF BATTERY IS REPLACED BY AN INCORRECT TYPE. DISPOSE OF USED BATTERIES ACCORDING TO THE INSTRUCTIONS.

Laser Light Supplement Warning

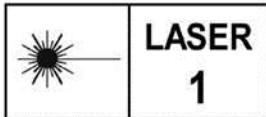

Warning: The laser radiation emitted from the device can cause eye injuries, burning of skin or inflammable substances. Before enabling the Light Supplement function, make sure no human or inflammable substances are in front of the laser lens.

Table of Contents

About This Manual	1
Overview of Contents	1
1 Overview	2
1.1 Box Content	2
1.2 Product Introduction	3
1.3 Functions	3
2 Appearance	5
2.1 Dimensions	5
2.2 Components	6
3 Basic Functions	7
3.1 Charging the Device	7
3.1.1 Charging via the charging base	7
3.1.2 Charging via the USB interface	9
3.2 Power On and Off	10
3.3 Interface Description	11
3.4 Focus Lens	12
3.5 File Exporting	13
3.6 Upgrade	14
3.7 Operation	14
4 Main Configurations	16
4.1 Temperature Measurement	16
4.1.1 Thermometry Settings	16
4.1.2 Thermometry Rule Configuration	18
4.2 Network Configuration	20
4.2.1 Wi-Fi Settings	20
4.2.2 WLAN Hot Spot Settings	21
4.2.3 Bluetooth settings	22
4.3 Storage Settings	22
4.3.1 Recording Settings	23
4.3.2 Capturing Settings	24
4.3.3 View recorded files	25
4.4 Image Configuration	26
4.4.1 Temperature Difference/Range	26
4.4.2 Palettes Settings	27
4.4.3 Thermal/Optical Configuration	28
4.5 Alarm Configuration	29
4.6 Other Configurations	30
4.6.1 Digital Zoom	30
4.6.2 LED Light Supplement	30
4.6.3 Laser Settings	31

4.6.4	Client Software.....	31
5	System Settings	33
5.1	Unit Settings.....	33
5.2	Display Settings.....	33
5.3	Auto Power-off Duration Settings	34
5.4	Device Initialization.....	34
5.5	Device Information	34
6	Appendix.....	35
6.1	Common Material Emissivity Reference	35
6.2	Frequently Asked Questions (FAQ)	36

About This Manual

This document introduces the way to perform and maintain the **Handheld Thermography Camera**.

It covers what is Handheld Thermography Camera, how to set up alarm and rules for Handheld Thermography Camera, concrete functions and descriptions of the camera. It shows you how to record and capture with the camera, and export the files. It also advises basic handling methods of frequently happened errors.

Overview of Contents

This document contains the following chapters, and appendixes:

Chapter 1 Overview introduces the handheld Thermography camera, including the box content, product introduction, and major functions.

Chapter 2 Appearance shows the dimensions of the camera and explains the functions of all components.

Chapter 3 Basic Functions describes how to charge, power on and off the camera, focus the thermal lens, and export file. It also tells the lens assembling procedure and how to operate it with touch-screen and by buttons.

Chapter 4 Main Configurations shows you the way to measure temperature and set temperature alarms. Besides, it describes how to record videos and capture snapshots. You can do Wi-Fi settings, palettes selection, temperature section settings, digital zoom, LED light control, and remote control via client software according to this chapter.

Chapter 5 System Settings indicates the unit settings, display settings, and device initialization, etc.

Chapter 6 Appendix lists the emissivity value of common materials for reference and the frequently asked questions.

1 Overview

1.1 Box Content

See the table below for the box content.

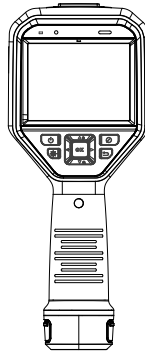

Handheld Thermography Camera (x1)

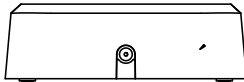

Charging Base (x1)

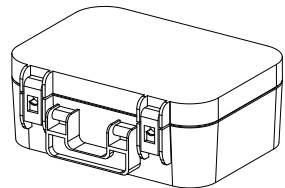

Box (x1)



power Adapter (x1)



USB Cable (x1)

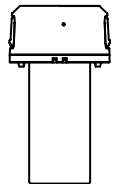

Battery (x1)

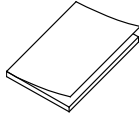

User Manual (×1)

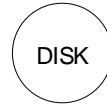

Disk (×1)

Note: The Handheld Thermography Camera includes one lens cover, one battery and one SD card.

1.2 Product Introduction

The handheld Thermography camera is a camera with both optical images and thermal images. It can do thermometry, video recording, snapshot capturing, alarm, and it can connect to Wi-Fi, Hotspot and Bluetooth. The built-in high-sensitivity IR detector and high-performance sensor detects the variation of temperature and measure the real-time temperature.

The Picture-in-picture technique of the Thermography camera and the fusion of optical view and thermal view, enhances the details of the images display. It supports multiple palettes and alarm types. When the detected temperature in the scene does not match with the alarm rules, the device alarms by color of the palette mode automatically. It helps the users to find the risky part and lower your property loss. The device supports Wi-Fi connection, live viewing, recording, and capturing, etc.

The handheld Thermography camera is easy to use, and adopts ergonomic design. It is widely applied to substations, electricity prevention detection of companies, and reconnaissance survey of construction field.

1.3 Functions

Thermometry

Device detects the real-time temperature, and display it on the screen.

Storage

Device is equipped with memory module to store recorded videos, captured snapshots, and important data.

Fusion

Device can display fusion of thermal view and optical view.

Palette and Alarm

Device supports multiple palettes, and you can set the palette mode according to the alarm function

Wi-Fi Function

Device can be connected to Wi-Fi. You can connect the device via Wi-Fi hot spot, and you can view live view, capture, and recording, etc.

Digital Zoom

Device supports 1×, 2× and 4× digital zoom.

LED Light:

LED light supplement makes the device a torch in required scenarios.

Laser Light Supplement:

Long-distance laser light supplement.

2 Appearance

2.1 Dimensions

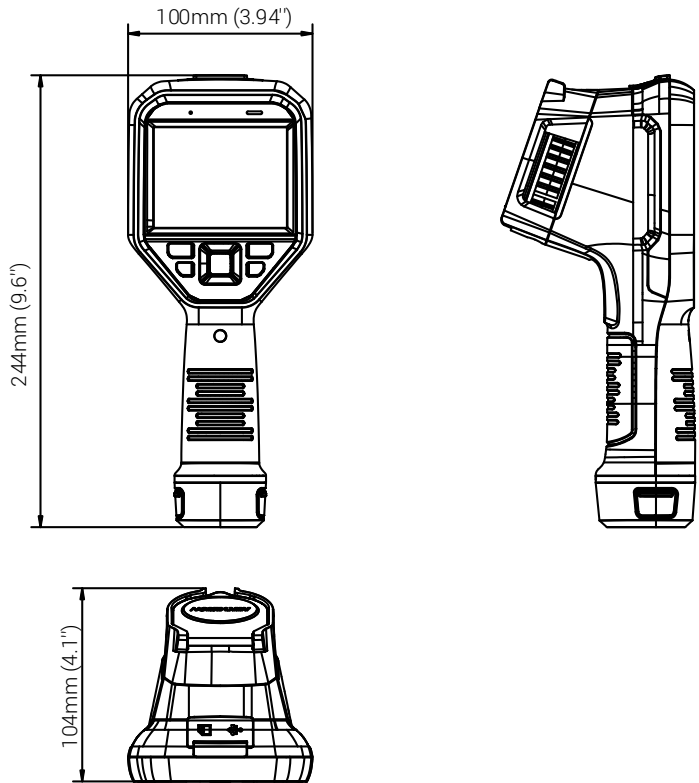

2.2 Components

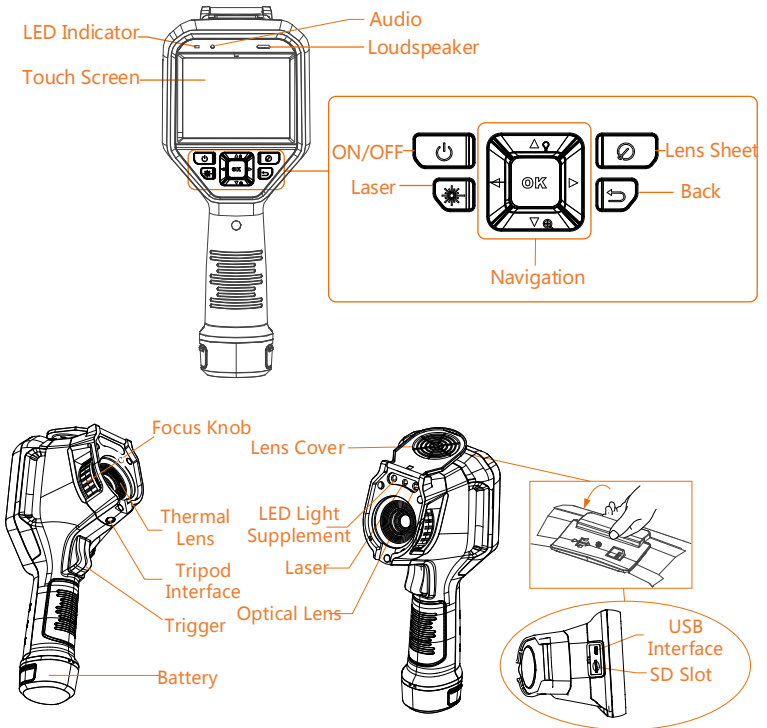

Laser Button Hold the **Laser** button to turn on laser, and release the button to turn off laser.

Navigation Button Menu Button:

- Press the ∇ , Δ , \triangleright , and \triangleleft button to select parameters.
- Press the **OK** button to confirm.

Non-Menu Button:

- Press the Δ button to turn on/off the LED light supplement.
- Hold the ∇ button to digital zoom.

Lens Sheet Button Cover the lens to perform the correction.

Back Button Exit the menu or return to previous menu.

Focus Knob Adjust lens focal length, refer to 3.4 **Focus**

Lens	
Trigger	Pull the trigger to record videos or capture snapshots.
USB Cover	Connect the camera to your PC via USB cable to export files.



Warning:

The laser radiation emitted from the device can cause eye injuries, burning of skin or inflammable substances. Before enabling the Light Supplement function, make sure no human or inflammable substances are in front of the laser lens.

3 Basic Functions

3.1 Charging the Device

3.1.1 Charging via the charging base

Note: Please charge the camera with the USB cable and power adapter supplied by the manufacturer (or according to the input voltage from the specifications).

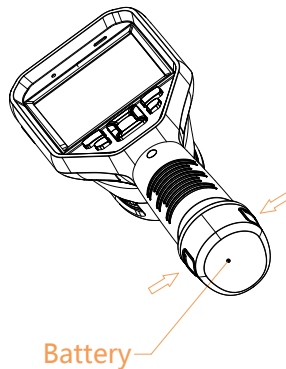

Steps:

1. Hold the camera, and press both battery lock catches of the Thermography camera, see figure below.

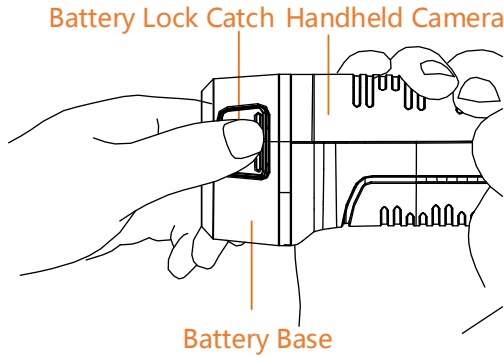

2. Hold the lock catches, and draw the battery base to take out the battery, see figure below.

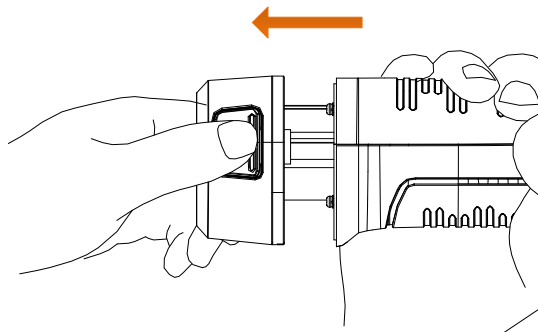

3. Insert the battery into the charging base, see figure below. You can see the charging status via the pilot lamp on the charging base.

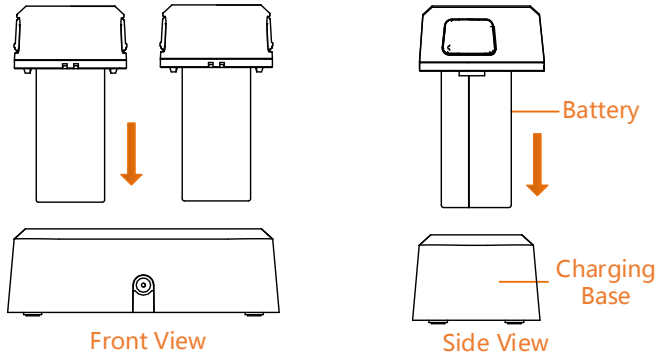

4. When the battery is fully charged, draw the battery from the charging base.
5. Align the ribbed piece on battery with the notch of the camera, and insert the battery into the camera, see figure below.

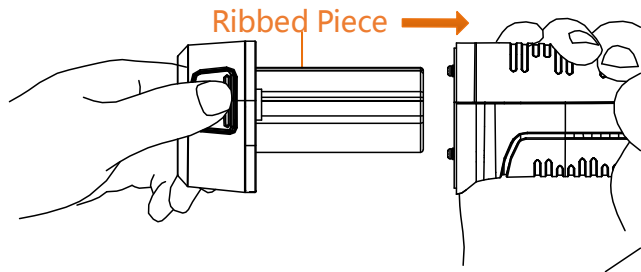

3.1.2 Charging via the USB interface

Note: Please make sure the battery is installed before charging.

Steps:

1. Open the top cover of the camera.
2. Connect the USB interface and the power adaptor with USB cable.

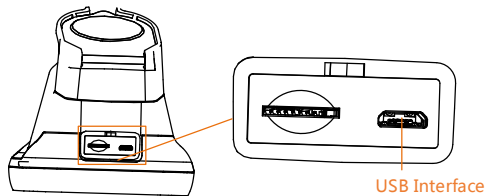

3.2 Power On and Off

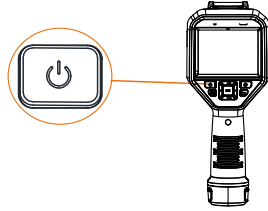

Power On

Remove the lens cover, and hold the  button for over three seconds to turn on the device. You can observe the target when the interface of the camera is stable.

Power Off

When the monocular is turned on, hold the  button for three seconds to power off the device.





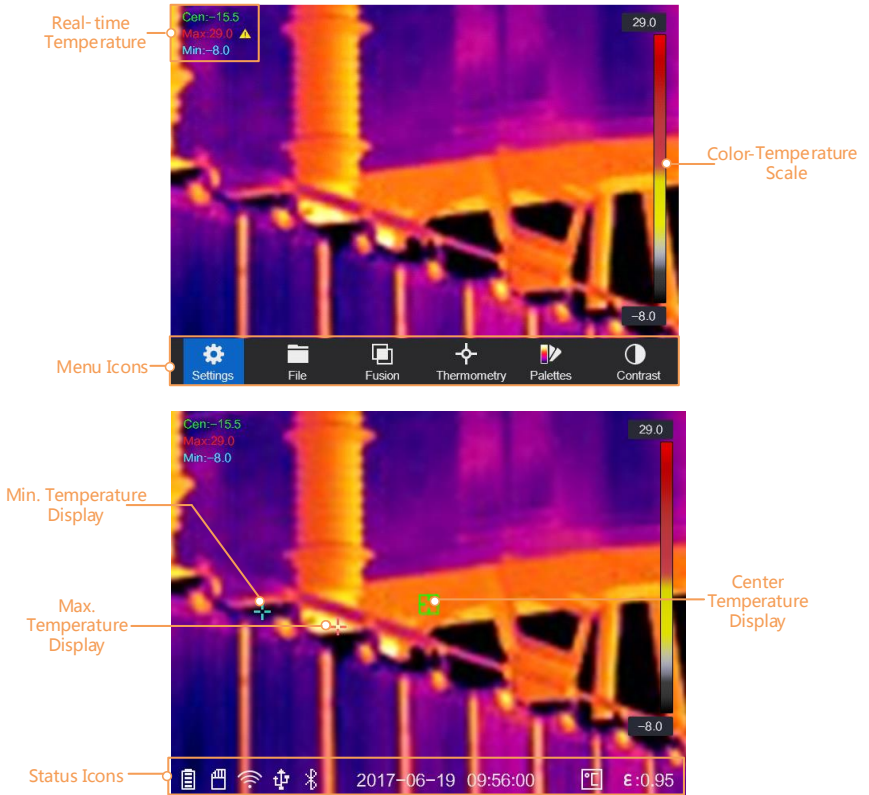

3.3 Interface Description

In the observation interface, tap the screen or press OK button to show the menu bar, see figure below.









For the descriptions of the menu buttons, see the table below.

	<p>Settings</p>	<p>In the Local Settings interface, you can set basic parameters, including thermometry units and range, fuse settings.</p>
--	-----------------	---

	File	You can view the capture snapshots or videos stored in File .
	Thermal/Optical	In the Thermal/Optical Settings () interface, you can set the display to thermal/optical/PIP/combined (fuse) modes.
	Thermometry	In the Thermometry Rule Configuration () mode, you can measure the real-time temperature by rules.
	Palettes	You can set the palettes of the display and the device displays accordingly.
	Contrast	You can adjust the contrast of display manually or automatically.

For the descriptions of the status icons, see the table below.

	USB	This icon shows whether the device is connected to PC via USB interface.
	Wi-Fi	This icon shows whether the device is connected to Wi-Fi or not.
	Hot Spot	This icon show whether the device hot spot is enabled or not.
	SD Card	This icons shows that the device memory card has short free space.
	Battery	This icon shows the battery status of the device.
	Unit	This icon shows which unit the device is using now: ° C, ° F, or Kelvin.

3.4 Focus Lens

Before you start:

Adjust the lens focal length properly before you set any other configurations, or it may affect the image display and temperature accuracy.

Steps:

1. Power on the handheld Thermography camera.
2. Aim the camera lens to the appropriate scene.

3. Adjust the focus knob clockwise or anticlockwise, see figure below.

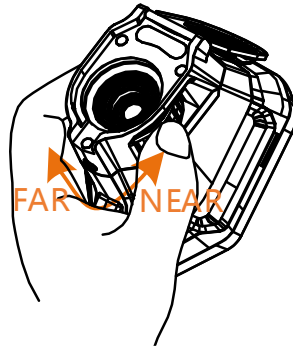

Do NOT touch the lens to avoid affecting the display effect.

3.5 File Exporting

Purpose:

Connect the handheld Thermography camera to your PC with USB cable, you can export the recorded videos and captured snapshots.

Steps:

1. Open the USB cover.
2. Connect the camera to your PC with USB cable and open the detected disk.
3. Enter USB > picture and USB > record to view the videos and snapshots.
 - Select and copy the videos to PC and play the file with the player.

- Select and copy the snapshots to PC and view the files.

4. Disconnect the device from your PC.

Note: For the first time connection, the driver will be installed automatically.

3.6 Upgrade

Steps:

1. Connect the thermography camera to your PC with USB cable and open the detected disk.
2. Copy the upgrade file and paste it to the root directory of the device.
3. Disconnect the device from your PC.
4. Reboot the device and then it will upgrade automatically. The upgrading process will be displayed in the main interface.

Note: After the upgrading, the device automatically reboot. You can view the current version in **Local Settings**  > **Device Information**.

3.7 Operation

The camera supports both touch-screen control and button control.

Touch-screen control

Tap on the screen to set parameters and configurations.

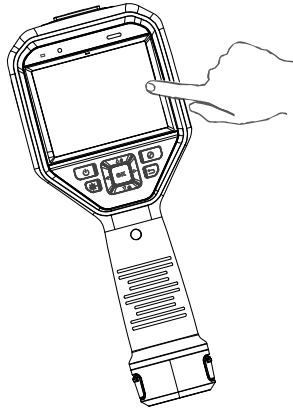

Button control

Press the navigation buttons to set parameters and configurations.

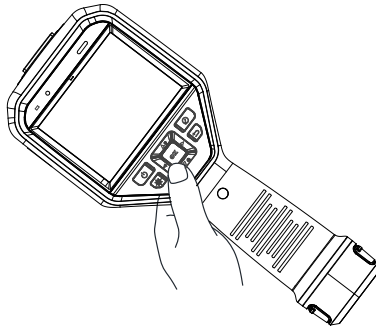

- Press the \triangle , ∇ , \triangleright , and \triangleleft button to move the cursor up/down/left/right.
- Press the **OK** button to confirm.

4 Main Configurations

4.1 Temperature Measurement

Before you start:

Go to **Settings > Device Settings > Unit Settings** to set the temperature unit as K/°C/°F. Refer to *5.1 Unit Settings* for details.

Purpose:

The thermometry (temperature measurement) function provides the real-time temperature of the scene and display it on the left of your screen. The thermometry function is turned on by default.

4.1.1 Thermometry Settings

Purpose:

The thermometry parameters affect the accuracy of temperature measurement.

Steps:

1. Select the **Local Settings** (⚙️) from the main menu.
2. In the **Local Settings** interface, select **Thermometry Settings**.

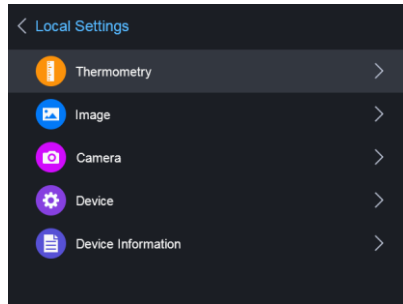

- 1) Set the **Thermometry Range**, **Emissivity**, **Distance**, **Background Temperature**, **Reflection Temperature**, **Humidity**, and **Temperature Bias**.

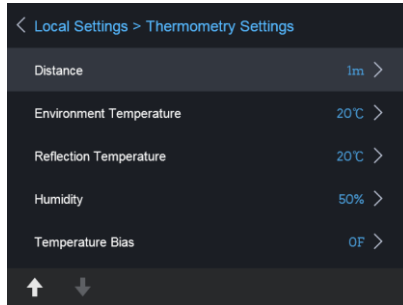

- Thermometry Range:

Select the thermometry range.

- Emissivity:

Set the emissivity of your target as the effectiveness in emitting energy as thermal radiation.

Note: Refer to the *6.1 Common Material Emissivity Reference* for Emissivity values.

- Distance (m/feet):

The straight-line distance between the target and the device.

- Background Temperature:

The average temperature of the environment.

- Reflection Temperature:

If any object (not the target) of high temperature is in the scene, and the target emissivity is low, set the reflection temperature as the high temperature to correct the thermometry effect.

- Humidity:

Set the relative humidity of current environment.

- Temperature Bias:

The device may have slight deviation of temperature measuring, you can set the **Temperature Bias** to correct it.

3. Return to previous menu to save the settings.

4.1.2 Thermometry Rule Configuration

Purpose:

The thermometry parameters affect the accuracy of temperature measurement.

Steps:

1. Select the **Thermometry Rule Configuration** (📏) from the main menu.
2. Set the point/line/frame rules, see figure below.

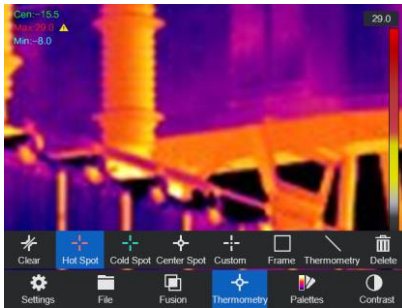

For Point Rule:

You can set Center Point Thermometry, High-Temperature Point, Low-Temperature Point, and Custom Point Thermometry.

- **Center Point Thermometry**
System detects the temperature of the center.

Step:

Tap 📏 and the temperature (center of view) displays **Gen: XX**.

- **High-Temperature Point** (🔥)
System locates the point of the highest temperature.

Step:

Tap 🔥 and the temperature (Highest temperature of view) displays **Max: XX**.

- **Low-Temperature Point**

System locates the point of the lowest temperature.

Step:

Tap  and the temperature (Lowest temperature of view) displays **Min: XX**.

● **Custom Point Thermometry** 

System detects the temperature of a custom point.







Steps:

- 1) Choose  on the interface.
- 2) Press **OK** button.
- 3) Move the point with the navigation buttons or tap on the touch-screen to select a point.
- 4) Press **OK** button to confirm. The temperature of custom point (e.g. P1) displays **P1: XX**.
- 5) Repeat step 1 to 3 to set other custom points.

Note: At most ten custom points supported.

For Frame Rule:

Steps:

- 1) Choose  on the interface.
- 2) Press **OK** button to generate a default frame.
- 3) Press the , , , and  button to move the frame up/down/left/right.
- 4) Press  to enlarge the frame, and press  to contract the frame. Or you can drag the corner of the frame on touch-screen to enlarge or contract the frame.
- 5) Press **OK** button to confirm. The Max. Temperature, Low Temperature, and Average Temperature of frame (e.g. S1) displays **S1 Max: XX Min: XX Avg: XX**.
- 6) Repeat step 1) to 5) to set other frames.

Note: At most three frames supported.

For Line Rule:



Steps:

- 1) Choose  on the interface.
- 2) Press **OK** button to generate a default line.
- 3) Press the Δ , ∇ , \triangleright , and \triangleleft button to move the line up/down/left/right.
- 4) Drag points of the line on the touch-screen to extend or shorten the line.
- 5) Press **OK** button to confirm. The Max. Temperature, Low Temperature, and Average Temperature of line (e.g. L1) displays **L1 Max: XX Min: XX Avg: XX**. The real-time temperature trend chart will display.

Note: Only one line supported.

Delete Rules:

Step:

- Tap  and press **OK** to clear all temperature rules.
- Or tap  and choose the single rule you want to delete to delete it.

4.2 Network Configuration

The handheld Thermography camera supports both Wi-Fi connection and WLAN hot spot.

4.2.1 Wi-Fi Settings

Purpose:

Connect the camera to Wi-Fi network, and you can control the camera via mobile client, etc.

Steps:

1. Select the **Local Settings** (⚙️) from the main menu.
2. Go to **Local Settings > Device Settings > Wi-Fi Settings**.
3. Tap on **Connect to Wi-Fi** to enable Wi-Fi, and the searched Wi-Fi will be listed below.
4. Select your Wi-Fi and enter password to show the keypad interface.
Note: Do NOT tap **enter** or **space**, or the password may be incorrect.
5. Tap **Close** to hide the keypad.
6. Tap **OK** to confirm.

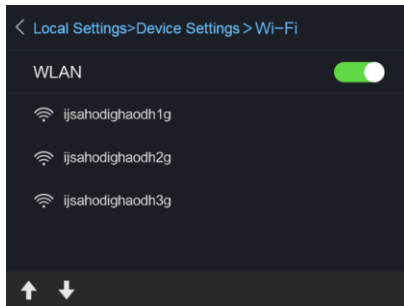

4.2.2 WLAN Hot Spot Settings

Purpose:

Set the handheld Thermography camera as a Wi-Fi AP, and connect your phone to the Wi-Fi. You can set the parameters of the camera via client software.

Steps:

1. Select the **Local Settings** (⚙️) from the main menu.
2. Go to **Local Settings > Device Settings > Wi-Fi Hotspot Settings**.
3. Tap on **Hot Spot** to enable the WLAN hot spot function.
4. Tap **Set Hot Spot** to set the WLAN hot spot. The hot spot name and password display automatically.
5. Edit the hot spot name and password, show the keypad interface.
Note: Do NOT tap **enter** or **space**, and at least 8 characters, or the password may be incorrect.
6. Tap **Close** to hide the keypad.

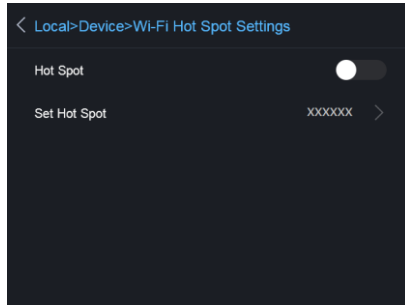

Result:

Connect your phone to the Wi-Fi. Refer to 4.6.4 *Client Software*.

4.2.3 Bluetooth settings

Purpose:

After pairing the handheld camera with bluetooth headsets successfully, you can record and hear the sound contained in the videos or images via bluetooth headsets

Steps:

1. Select the **Local Settings** (⚙️) from the main menu.
2. Go to **Local Settings > Device Settings > Bluetooth**.
3. Tap on **Bluetooth** to enable the bluetooth function. The handheld camera will search the nearby enabled bluetooth headsets and pair them automatically.

Note: You can also press  or **OK** button to quit the pairing.

4. After pairing you can record and hear the sound via the headsets while recording and playing the video or image.

4.3 Storage Settings

Insert memory card into the camera, and you can record videos, capture snapshots, and mark and save important data.

Notes:

- Thermography camera does not support capturing or recording when the menu is shown.
- When the Thermography camera is connected to your PC, it does not support capturing or recording.
- Go to **Local Settings > Device Settings > Filename Header**, you can set the filename header for capturing or recording to distinguish the files recorded in a specify scene.

4.3.1 Recording Settings

Steps:

1. Select the **Local Settings** (⚙️) from the main menu.
2. Go to **Local Settings > Camera Settings > Trigger Settings**
3. Select the **Record**.
4. Press **OK** to confirm.

Note: You can set the **Flashlight Setting** ON/OFF if required.

5. Press (⏪) to exit the setting interface.
6. In the live view interface, pull the trigger to start recording. The recording icon and count down number display in the interface.



7. When you finish, pull the trigger again to stop recording. The recorded video will be saved automatically and exit.

Note: You can also press **OK** or  to stop recording.

8. Refer to *3.5 File Exporting* to export the videos.

Note: in the menu interface, you can pull the trigger to exit, and pull the trigger again to start recording.

4.3.2 Capturing Settings

Steps:



1. Select the **Local Settings**  from the main menu.
2. Go to **Local Settings > Camera Settings > Trigger Settings**
3. Select the **Capture**.
4. Press **OK** to confirm.

Note: You can set the **Flashlight Setting** ON/OFF if required.

5. Press  to exit the setting interface.
6. In the live view interface, pull the trigger to capture snapshot.



7. The live view freezes and device displays the snapshot editing interface.
 - 1) Set text remark or voice remark.
 - Tap  to add text remarks. Tap the screen to show the keypad interface, enter the comment and confirm.

- Tap  to add voice remarks. Hold the **OK** button to start recording and release the button to stop recording.
 - 2) Add thermometry data.
 - Tap  to add thermometry rules, refer to *4.1.2 Thermometry Rule Configuration* for details.
 - 3) Tap  or pull the trigger to save the snapshot.



Note: You can also press  to quit the saving.
8. Refer to *3.5 File Exporting* to export the snapshots.
Note: in the menu interface, you can pull the trigger to exit, and pull the trigger again to capture snapshot.

4.3.3 View recorded files

Steps:

1. Select the **Files** () from the main menu.
2. Press the Δ , ∇ , \triangleright , and \triangleleft button to select the video or , capture snapshot.
3. Press **OK** to confirm.

Note:

- When you are viewing the videos or capture snapshots, you can switch the file by tapping  or .
- When you are viewing the capture snapshots, You can tap  to play the sound.
- For more information contained in capture snapshots or videos, you can install the thermography client to analyze them. You can get the thermography client software from the disk packed in box.

4.4 Image Configuration

Set the image temperature difference and temperature range of the scene.

4.4.1 Temperature Difference/Range

Purpose:

Set a temperature section and the palette only works for targets within the temperature section. You can adjust the temperature range and set the temperature difference.

Steps:

1. Select the **Temperature Difference/Range Settings** (📊) from the main menu.

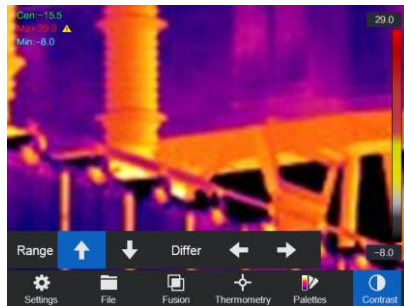

2. Select **Auto** (📊) adjustment or **Manual** (👇).

For Auto Adjustment:

- 1) Select **Auto** (📊).
- 2) Press **OK** to confirm. The device adjusts temperature difference and temperature range parameters automatically.

For Manual Adjustment:

- 1) Select **Manual** (👇).
- 2) Press **OK** to confirm. The color-temperature bar displays.

- 3) Press \triangleright to enlarge the temperature section range (e.g. temperature range changes from $20^{\circ}\text{C} - 40^{\circ}\text{C}$ to $19^{\circ}\text{C} - 41^{\circ}\text{C}$), or press \triangleleft to narrow the temperature range.
 - 4) Press \triangle to move the temperature section higher (e.g. temperature range changes from $20^{\circ}\text{C} - 40^{\circ}\text{C}$ to $30^{\circ}\text{C} - 50^{\circ}\text{C}$), or press ∇ to lower the temperature section.
3. Press  to exit the setting interface.

4.4.2 Palettes Settings

Purpose:



The palettes allow you to select the desired colors. white hot, black hot, fusion, rainbow, ironbow, red hot, and dark blue are selectable.



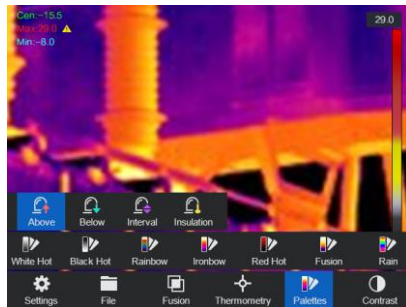

Steps:

1. Select the **Palettes Settings**  from the main menu.



2. Tap on the icons to select a palette type.

	White Hot: The hot part is light-colored in view.
	Black Hot: The hot part is black-colored in view.
	Rainbow The target displays multiple colors, it's suitable for scene without obvious

		temperature difference.
	Ironbow,	The target is colored as heated iron.
	Red Hot:	The hot part is red-colored in view.
	Fusion	The hot part is yellow-colored and the cold part is purple-colored in view.
	Rain	The hot part in the image are colored, and the else is blue.

3. Press  to exit the setting interface.

4.4.3 Thermal/Optical Configuration

Purpose:



You can set the thermal/optical view of the device. Thermal, Fusion, PIP, Optical are selectable.

Steps:

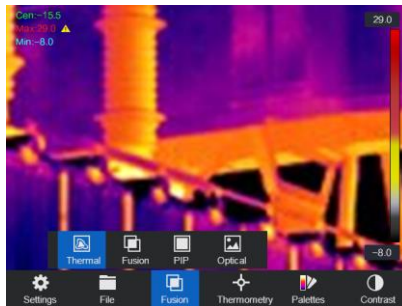
1. Select the **Thermal/Optical Settings**  from the main menu.



2. Tap on the icons to select a view mode.

	Thermal	In thermal mode, the device displays the thermal view.
	Combined	In combined mode, the device displays the combined view of thermal channel and optical channel.
	PIP Mode	In PIP (Picture in Picture) mode, the device displays thermal view inside the optical view.

	Optical	In optical mode, the device displays the optical view.
---	---------	--

3. Press  to exit the setting interface.

4.5 Alarm Configuration

Before you start:

Go to **Palettes Settings** () to set the palette.

Purpose:



Set the alarm rules and the device will alarm when the temperature triggers the rule.

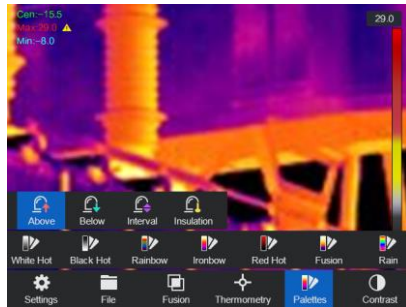

Steps:

1. Go to **Palettes Settings** () from the main menu.



2. Tap on the icons to select an alarm rule type.
3. (Optional) Press the Δ and ∇ to select between upper limit and lower limit.
4. Press the \triangleleft and \triangleright to adjust the rule temperature.

	Above Alarm	Set the alarm temperature, and the device alarms when target temperature is higher than rule temperature.
	Below Alarm	Set the alarm temperature, and the device alarms when target temperature is lower than rule temperature.

	<p>Interval Alarm</p>	<p>Set the alarm temperature section (e.g., 90°C - 150°C), when target temperature is within the section (e.g., 100°C), the device alarms.</p>
	<p>Insulation Alarm</p>	<p>Set the alarm temperature section (e.g., 90°C - 120°C), when target temperature is without the section (e.g., 70 °C or 125°C), the device alarms.</p>

5. Press  to exit the setting interface.

Note: Go to **Local Settings > Image Settings > Audible Warning**, Tap on  to enable audible warning. The device will sound When alarm is triggered.

4.6 Other Configurations

You can set the digital zoom, control the LED indicator and laser, and control the device via client software.

4.6.1 Digital Zoom



Purpose:

Digital zoom in the view, and you can view the target or scene in larger size.

Step:

In the live view interface, press the  button to adjust the digital zoom to 1x, 2x, or 4x.

4.6.2 LED Light Supplement

Go to **Local Settings > Device Settings > Light Supplement**, Tap on  to enable LED light, or press the  button in the live view interface to enable/disable the LED light.

4.6.3 Laser Settings

In the live view interface, hold the  button to enable/disable the laser light.



Warning:

The laser radiation emitted from the device can cause eye injuries, burning of skin or inflammable substances. Before enabling the Light Supplement function, make sure no human or inflammable substances are in front of the laser lens.

4.6.4 Client Software

- **Task 1. Connect the Camera to Wi-Fi**

Purpose:

Connect the camera to Wi-Fi network, and you can control the camera via mobile client, etc.

Steps:

1. Connect your device to Wi-Fi network, refer to [4.2.1 Wi-Fi Settings](#).
2. Download and install the iVMS-4500 client software to your phone.
3. Launch the app.
4. Follow the startup wizard to create, and register an account.
5. Add the handheld Thermography camera to online devices.

Result:

View the live view, capture snapshots, and record videos via the client.

- **Task 2. Set the Camera as Wi-Fi AP**

Purpose:

Set the camera as a Wi-Fi AP, and connect your phone to the Wi-Fi. You can set the parameters of the camera via client software.

Steps:

1. Set your device as Wi-Fi hot spot, refer to [4.2.2 WLAN Hot Spot Settings](#).

2. Download and install the iVMS-4500 client software to your phone.
3. Launch the app.
4. Follow the startup wizard to create, and register an account.
5. Connect your phone to the WLAN Hot Spot of the camera.
6. Select Wi-Fi configuration in the software, enter the serial number of camera to add the device. Refer to the manual of client software for details

Result:

View the live view, capture snapshots, and record videos via the client.

5 System Settings

In the system settings interface, you can set the display brightness, CVBS output, device initialization parameters, and view the device information.

5.1 Unit Settings

Go to **Local Settings** (🔧) > **Device Settings** > **Unit Settings**

For Temperature Unit:

Set the temperature unit as Degree Celsius (°C)/Degree Fahrenheit (°F)/Degree Kelvin (K).

For Distance Unit:

Set the distance unit as Meter (m)/Feet (').

5.2 Display Settings

Go to **Local Settings** (🔧) > **Device Settings** > **Display Brightness**

For Screen Brightness:

Set the screen brightness as Low/Medium/High.

Go to **Local Settings** (🔧) > **Image Settings** > **Display Settings**

For Status Icons:

Enable/disable the statue icons display.

For Time:

Enable/disable the date and time display.

For Parameters:

Enable/disable the parameters display. Parameters means the material emissivity and the temperature unit.

Go to **Local Settings** (⚙️) > **Image Settings** > **CVBS Output**

For CVBS Output:

Enable/disable the CVBS output.

Note: Connect the camera to external CVBS display unit before you enable the **CVBS Output** function.

5.3 Auto Power-off Duration Settings

Go to **Local Settings** (⚙️) > **Device Settings** > **Auto Power-off Duration Settings** to set the automatic shutdown time for device as required.

5.4 Device Initialization

Go to **Local Settings** (⚙️) > **Device Settings** > **Device Initialize** to initialize the device and restore default settings of Measurement Tool, Device Storage, and Restore Default Settings (Restore all parameters).

5.5 Device Information

Go to **Local Settings** (⚙️) > **Device Information** to view the device information: Model, Version No., FPGA Version No., Serial No., IP address and so on.

6 Appendix

6.1 Common Material Emissivity Reference

Material	Emissivity
Human Skin	0.98
PCB	0.91
Cement Concrete	0.95
Ceramics	0.92
Rubber	0.95
Paint	0.93
Wood	0.85
Asphalt	0.96
Brick	0.95
Sand	0.90
Soil	0.92
Cotton	0.98
Cardboard	0.90
White Paper	0.90
Water	0.96

6.2 Frequently Asked Questions (FAQ)

Q: The charge indicator flashes red.

A: Examine the items below.

1. Examine whether the device is charged with the standard power adapter.
2. Plug and unplug the battery once.
3. Make sure the charging temperature is above 0°C (32°F).

Q: Device image is fuzzy.

A: Refer to 0

Focus Lens to adjust the focus knob clockwise or anticlockwise.

Q: Wi-Fi is not found.

A: Examine whether the Wi-Fi function is turned on. If not, refer to 4.2.1 *Wi-Fi* to turn on Wi-Fi.

Q: Capturing or recording fails.

A: Examine the items below:

1. Whether the device is connected to your PC and disabled the capturing and recording.
2. Whether the storage space is full.
3. Whether the device is low-battery.

Q: The PC cannot identify the camera.

A: Examine whether the device is connected to your PC with standard USB cable.



See Far, Go Further