



FIRECLASS

FC503 & FC506 Addressable Fire Control Panels



www.fireclass.net

Installation Manual

Doc. Version 2.0
23 October 2019

To program the fire control panel, use the Software FireClass FC500 (FC501_FC503_FC506) Console release 01.00.01 or higher. Use control panel FW version 1.01 or higher.

Johnson Controls assumes no responsibility for damage to products resulting from improper application or misuse.

Installation of this control panel must take place strictly in accordance with the instructions in this manual and in compliance with the local laws and bylaws in force.

The FC503 and FC506 fire control panels comply with the essential requirements of standards EN54-2, EN54-4 and EN54-21.

Box contents

The control panel is contained in a box. See the contents below:

- A sheet metal cabinet and plastic door with an assembled motherboard and power supply switching.
- The Quick Start Guide.
- A transparent plastic bag containing a USB consisting of the installation manual, user manual, the PC Programming manual, two 3.9 kOhm resistors, a 320 mm red and a black cable with a faston terminal to connect batteries with the main board, and a 320 mm black cable with two faston terminals to connect batteries.
- Proceed carefully to unpack the contents and dispose recyclable materials in accordance with local laws.

Recycling information

The manufacturer advises that customers dispose of any used equipment such as panels, detectors, sirens, and other devices in an environmentally friendly manner. Potential eco-friendly methods include reusing parts or whole products and recycling of products, components, and materials.

Waste Electrical and Electronic Equipment (WEEE) Directive

In the European Union, you must dispose of this product separate to household waste at an appropriate facility to enable recovery and recycling.

Note: The FC503 and FC506 fire control panels support several addressable devices such as detectors, modules, and manual call points. The present manual includes the instructions for the programming of the fire control panels. For further information on these devices and their accessories, visit www.fireclass.net and log into the Reserved Area, under Installation Manuals.

The manufacturer reserves the right to change the technical specifications of these products without prior notice.

Keywords and symbols

In this manual, symbols used in the margin indicate warnings. These symbols are explained in Table 1.

Table 1: Keywords and symbols



Keyword	Symbol	Explanation
DANGER		Warning. Imminent danger. Death or severe injury when disregarded.
WARNING		Warning. Potentially dangerous situation. Death or severe injury possible when disregarded.
CAUTION		Warning. Potentially dangerous situation. Minor injury possible when disregarded.

Table of Contents

Introduction.....	5	Verifying the functionality of the circuit.....	30
FC503 & FC506 fire control panel	5	Programming from the panel	31
Accessory items.....	5	Using the system.....	31
Description	5	Operating the system from the panel	31
Inputs	5	Assistant text composition.....	32
Outputs.....	5	MAIN screen - accessing the system.....	34
Operating features	5	Insert password	34
Interface	8	PROGRAM screen	35
Access to signaling and commands	8	0 Key - insert modify password	35
Users and installers features	8	1 Key- Auto-enrolling (auto-learning)	36
Power supply	9	Auto-addressing procedure	38
Description of the FC500 repeater signaling	9	2 Key – Device	40
FC500 repeater control keys.....	9	3 Key - SW zone.....	42
FC500 repeater LED description	9	4 Key – output	44
Description of the control keys (panel)	9	5 Key- network.....	46
The status LED	10	6 Key – Map Device	47
Parts identification	12	7 Key – USB.....	47
Description of parts	12	8 Key – System	49
Installation	16	9 Key- Restore default.....	50
Installing the control panel.....	16	FC500 repeater address	50
Installing FC500 repeater.....	19	Modify	51
Description of the terminals	19	Accessing the MODIFY menu	51
Telephone line	19	Disable	52
Fire	19	Accessing the DISABLE menu.....	52
Fault	20	7 Key - password (DISABLE).....	52
Auxiliary outputs.....	20	9 Key- sounders.	52
RS485	21	Quick start-up procedure	54
Battery.....	21	Procedure	54
The system wiring.....	21	System default.....	56
Connecting addressable devices.....	21	Accessories.....	60
Connecting repeater FC500.....	22	FC500IP IP module.....	60
Connecting output devices.....	24	4B Universal base	60
Bell outputs	24	FC460H or FC400H Addressable heat detector	60
Connecting the power supply	25	FC460P or FC400P Addressable optical smoke.....	60
Connecting the mains supply.....	25	FC460PH or FC400PH Addressable optical smoke & heat detector.....	60
Thermal probe.....	26	FC460PC Addressable optical smoke & heat detector & CO	60
Connecting the thermal probe to the control panel.....	26	FC410MIM Mini input module	61
Installing the FC500IP board	28	FC410MIO Small addressable multi I/O module.....	61
Installing the 38Ah battery metal box.....	29	FC410SIO Single input and output module.....	61
Maintenance	29	FC420CP Addressable break glass callpoint (indoor) .	61
		FC421CP Addressable break glass callpoint (outdoor)	61

FC430SAB/SAM Sounder base address modules	61
FC430SB Loop low power sounder base	61
4B-I Isolator base	61
FC490ST Loop service tool	62
FC410CIM Contact input module	62
FC410DIM Detector input module	62
FC410RIM Relay interface module.....	62
FC410BDM Beam detector module.....	62
FC400CH Addressable carbon monoxide + heat detector	62
801RIL Remote LED Indicator	62
801HL Remote LED indicator	62
HVR800 High voltage relay.....	62
DPK4 and DPK4I	63
FIRERAY 50/100-Optical Beam Smoke Detector	63
FIRERAY 3000	63
FIRERAY 5000	63
FC410LPSY and FC410LPAV Loop..... powered sounders and sounder-beacons	63
FC410LPBS-R/W Loop powered sounders and sounder- beacons (EN54-23).....	63
FC430LPSB and FC430LPASB loop powered addressable sounder beacon base.....	64
FC430LPBSB Loop powered addressable sounder/beacon base (EN54-23).....	64
FC410SNM Sounder notification module	64
FC410TSM Door control module	64
FC410DDM Universal fire and gas detector module ...	65
FC410QMO Quad monitored output module.....	65
FC410QRM Quad relay module	65
FC410QIO Quad input output module	65
FC440SB Addressable Base Sounder	65
FC440AVB Addressable Sounder Base VAD Sounder	65
FC503/6 Firmware upgrade quick guide	66
Firmware upgrade procedure using FireClass FC500 (FC501_FC503_FC506) Console software	66
Firmware upgrade procedure using the USB pen drive	67
Specifications	68
Technical features.....	68
Description of the terminals	68
CPR information.....	72

Introduction

FC503 & FC506 fire control panel

The FC503 and FC506 fire control panels follow Johnson Controls' highest standards of quality and performance.

Find further details on the FC503 and FC506 fire control panels below:

FC503

FC503 is an analogue addressable fire control panel with one main loop (three sub loops), that can support up to **250 addressable devices and 128 zones**. BAQ140T24 switching power supply powers FC503 at 5.5A @ 27.6 ±1 %V. Suitable batteries include two *12 V/ 17Ah or two *12 V/ 38Ah. The user interface has LEDs and icons.

FC506

FC506 is an analogue addressable fire control panel with two main loops (six sub loops). The panel can support up to **500 addressable devices and a maximum of 250 devices in a single main loop, and 256 zones**. BAQ140T24 switching power supply powers FC506 at 5.5A @ 27.6 ±1 %V. Suitable batteries include two * 12 V/ 17 Ah or two * 12 V/ 38 Ah. The user interface has LEDs and icons.

Note: In this manual, the term FC503 describes the characteristics common to both FC503 and FC506. Notes added describe the characteristics specific to the FC506 panel.

Note: The components of these control panels operate correctly when external ambient conditions comply with the requirements of class EN60721-3-3:1995.

The FC503 control panel has a 4-line, 40 characters per line LCD module with a backlight, which provides written information regarding the system status and for programming the control panel.

Accessory items

FC500

Use this repeater panel for connecting with four wires to FC500 control panels. The repeater panel provides all the visible and audible warnings generated by the control panel. The repeater panel also allows end users to manage the system remotely up to 1000 m with double twist unshielded cable. The FC503 control panel supports up to eight FC500 repeater panels.

FC500-MFI

This is a programmable, multifunctional module for connecting to a real time printer. Furthermore, with terminal blocks, you can connect a standard interface to remotely control and supervise a set of inputs and outputs to manage the control panel.

FC503/FC506 client

The FC503 and FC506 master control panel supports up to seven FC503 or FC506 client control panels. These client control panels expand the FC503 and FC506 system in a modular way.

FC500IP

FC500IP is a module that connects the control panel to a LAN. See [Installing the FC500IP board](#).

FireClass FC500 (FC501_FC503_FC506) Console

This is a user-friendly software application that has Microsoft Windows 7 and higher. The console offers easy ways to program the control panel and also provides event log functions.

FireClass Console Multi Account Engine (FCMAE)

FCMAE allows you to monitor multiple Fireclass systems across the world from a single work station. It manages up to 32 FC500 series panels (FC501, FC503, FC506) plus legacy panels (FC510 and FC520) connected by Ethernet through the FC500IP3 module showing the real time status and alerting the operator once an event occurs in one of the monitored systems.

Description

Inputs

FC503: The one main loop (three sub loops) manages up to 250 devices.

FC506: The two main loops (six sub loops) manage up to 500 devices (250 devices per main loop).

Outputs

This section describes how the control panel outputs operate.

Supervised outputs

With this output, the control panel can detect and signal short circuits and power supply interruptions.

Bypassable disabled outputs

You can disable, by means of the respective key, this type of output.

Silenceable outputs

To stop this type of output, you can use the Silence/Resound Sounders key. You can silence the outputs for an indefinite period during Day Mode or for the programmed silence time during Night Mode.

Operating features

You can program the FC503 control panel to provide WARNING or Delay to Alarm status before ALARM status.

The WARNING display signals the WARNING status. If a detector exceeds its warning threshold, the control panel generates a warning. The input module also generates a warning state; a useful feature for implementing the Systems Supervision capability.

Warning status signals:

- Control panel buzzer; 2 seconds of sound at 440 Hz and then 2 seconds of pause.
- A WARNING message on the LCD display
- The WARNING output points if a user enables the Delay to Alarm option.

Delay to Alarm

If a zone generates an alarm during Day Mode, the control panel starts the Delay to Alarm Time. The Delay to Alarm status signals are:

- Control panel buzzer; 0.5 seconds of sound at 880 Hz and then pause for 0.5 seconds.
- Blinking on the **Delay to Alarm** LED for the first eight zones only.
- Message ALARM+DLYTIME on the LCD display.
- Activation of respective outputs, if the user enables the Delay to Alarm option.

Note: If the control panel detects alarm conditions during Night Mode or from a callpoint, the control panel generates an instant alarm.

Take the following actions during the Delay to Alarm status; see [Access to signaling and commands](#).

- Access Level L1:** to activate an Evacuation Alarm, press and hold the **Evacuate** Key.
- Access Level L2:** to stop the Silence disable outputs and interrupt the Delay to Alarm Time, press the **Silence** key.

When the Silence LED is on during Silence status, press the **Silence** key to release the Silenceable outputs, or press the **Reset** key to restore standby status.

If the control panel operates in Night Mode, the control panel exits from Silence status automatically when the programmed Silence time expires.

Alarm

When the Delay to Alarm time expires, the control panel generates an alarm. The Alarm status signals are:

- Control panel buzzer; 0.2 seconds of sound at 3300 Hz and then 0.2 seconds of pause.
- Alarm LED is on.
- An alarm message on the LCD display.
- Activation of the Fire and SC1 outputs.
- Activation of other outputs including SC2, OC1, or OC2 if programmed.

During the Alarm status, the following can occur:

- At Access Level 2 you can stop the Silenceable outputs by pressing the **Silence** key.
- At Access Level 2 you can press the **Reset** key and Silence Buzzer.

Note: Refer to [Access to signaling and commands](#) for further information.

During the Silence status when the Silence LED is on, use the **Silence** key to release the Silenceable outputs. The **Reset** key restores the standby status.

When the programmed Night Mode Silence time expires, the control panels exits Silence status.

Day and night mode

The control panel can operate in Day or Night Mode. See the relevant section in the “PC Programming” chapter.

If you silence the system in Day Mode, the Silence status remains until you unmute the system, provided that no other alarm incidents occur. If you silence the system during Night Mode, the Silence status remains until the Night Mode Silence time expires.

At default, the system is set to Day Mode. During Day Mode, silenced alarms are not unmuted automatically.

Fault

This control panel can detect and signal the faults shown in [Table 2](#). Fault conditions signals are:

- Control panel buzzer; 1 second of sound at 660 Hz and pause for 1 second.
- The Fault LED and relative Fault LED is on.
- A Fault message on the LCD display.
- Activation of the Fault output.
- Activation of other outputs including SC2, OC1 or OC2 if programmed.

The Fault output and any additional programmed fault outputs automatically restore to standby when fault conditions clear.

Under certain circumstances, fault conditions may clear spontaneously. If this occurs, the memory stores the event until you reset the control panel. Blinking on the Fault LED signals stored fault events.

Silence

This control panel provides a **Silence** key that can restore the Silenceable outputs to Standby status.

When the Silence LED is on, this signals the Silence status.

The Silence status remains until one of the following occurs:

- You press the Silence key again
- The programmed Night Mode Silence time expires when the control panel operates in Night Mode.
- A new alarm condition is detected.

Table 2: Description of faults

Message	Problem
Mains fault	The control panel is not powered from the mains
Battery	The control panel's batteries charger not working properly
Low battery	The control panel batteries are empty
Earth	Leakage to earth
24A Output	Shorted 24A Output
24R Output	Shorted 24R Output
Firmware main contr.	Checksum fault
Not programmed dev	Loop device without address
Loop return open	Loop negative signal open
Loop signal open	Loop positive signal open
Loop local short	Local short on loop controller
Loop right short	Right side loop short
Loop left short	Left side loop short
Non answer	Loop device does not answer
Dirty level	Smoke detector only; the dirty threshold has been exceeded
Short circuit	Short circuit on input module
Open circuit	Open circuit on input module
Power supply	Main fault
Wrong value	A loop device has an incorrect value
Stuck output	An output module relay is not switched
Same address	Several loop devices have the same address
Wrong Type	Different loop device from that programmed in the panel
IP Communicator	Communication lost with IP controller
IP receiver	Communication lost with IP receiver
PSTN communicator	The communication with PSTN controller is lost
Telephone line	Telephone line fault
LOG Full	LOG fault
PSTN Action not Ack.	A PSTN action not acknowledged
SC X short	SC x= (1 or 2) short circuit
SC X open	SC x (1 or 2) open terminal
Prog.data main cont	Data programming checksum fault
Prog.data tel.board	Aux Controller data programming checksum fault
Loop Communication	Communication loop fault controller
Display communication	Communication fault on display controller
LOOP x NOISY	The devices on the loop x (1, 2 or 3) do not communicate properly with the panel. Check the quality of wiring.
REPEATER COMMUNIC.	A repeater on the RS485 does not respond
MFI x COMMUNIC.	(x from 1 to 4)
67PRINTER x FAULT	(x from 1 to 4)
PRINTER x ABSENT	(x from 1 to 4)
MFI x SERIAL CHANN.	(x from 1 to 4)
MFI x INy SHORT	(x from 1 to 4; y from 1 to 5)
DEFAULT DATA	The fire panel resets to default data

Note: You can only mute the Silenceable outputs manually at access level 2 or 3.

Disabled

This control panel can disable the devices on the loop, SC2 output, OC1 and OC2 outputs, the software zones, the RS485 network devices such as repeater, client panel, and FC500MFI.

DISABLED zones cannot generate alarms or warnings of any kind, and DISABLED outputs cannot be activated.

When the Disabled LED is on, this signals the Disabled status.

Note: The Disable facility is only available at access level 2 or 3.

Reset

Resetting the control panel restores the outputs to standby status, clears the memory, and disconnects the power supply to terminal 24R for 2 seconds.

Note: Resetting the panel can only occur at access level 2 or 3.

Interface

Visual signaling

The system status signals on the control panel LEDs are as follows:

- Green indicates power ON condition
- Amber indicates specific operating modes, for example Day or Night Mode, and Fault conditions.
- RED indicates alarm conditions.

Memory

The control panel signals Fault events by FAULT LED blinking until the system resets, even if the event clears in the meantime.

Audible Signaling

The buzzer signals the control panel status as shown in Table 3.

Note: When the control panel mutes an alarm and detects a new fault, the control panel resounds the previous silenced alarm.

Table 3: Audible Signaling

Status	Sound	Pause	Frequency
SYSTEM FAULT (Main processor fail)	2.5 s	2.8 s	1300 Hz
SYSTEM FAULT (Programming data corrupted)	1 s	1 s	660 Hz
Warning	2 s	2 s	440 Hz
Delay to Alarm	0.5 s	0.5 s	880 Hz
Alarm	0.2 s	0.2 s	3300 Hz
Fault	1 s	1 s	660 Hz

LAMP TEST:

This key allows you to test the control panel buzzer and LEDs.

Access to signaling and commands

There are four access levels, in compliance with the Fire Safety Regulations in force.

Access Level1 (L1) Viewing:

All persons can view the control panel status without a password required.

Access Level 2 (L2) Operating the system (PIN code entered):

Password code users can operate the system at user level.

Access Level 3 (L3) Programming and Opening the Control Panel (Password Code entered):

This level of access is for installers. Therefore, only qualified, authorised users are allowed to open the control panel door, which requires removal of cover screws, for maintenance or battery replacement purposes.

Access Level 4 (L4) Repairing or replacing the PCB:

Only the manufacturer can repair or replace the PCB that requires removal of the cover screws.

Users and installers features

The panel can recognize and manage up to eight different users and two different installers. At each login of any user or installer, the panel logs the login event and the user or installer's ID. The panel also logs the return to access level 1 to indicate the end of the user or installer's session. The default passwords for the eight users are as follows:

USER 1	11111
USER 2	22222
USER 3	33333
USER 4	44444

USER 5	55555
USER 6	66666
USER 7	77777
USER 8	88888

The default passwords for the two installers are as follows:

INSTALLER 1	00000
INSTALLER 2	99999

By default, only USER 1 works with its default password. The other users are unavailable and disabled. USER 1 may be enabled and available.

By default, only INSTALLER 1 works with its default password. The other installers are unavailable and disabled. INSTALLER 1 may be enabled and available.

Only INSTALLER 1, using the FireClass FC500 (FC501_FC503_FC506) Console or panel user interface, can modify the availability and enable the status of USERS 2 to 8 and INSTALLER 2.

The INSTALLER 1, using the FireClass FC500 (FC501_FC503_FC506) Console or panel user interface, may modify the password for USERS 1 to 8 and INSTALLER 2.

Each installer or each user can modify their own password.

When INSTALLER 1 enters the first password through the user interface to a user or installer, the system declares the password "available" and enables access.

If INSTALLER 1 loses their password, they can enter a new password using the following procedure:

1. Remove the two screws at access level 4, open the fire panel, and remove the jumper J5 of the main board.
2. Access the installer menu screen.
3. Access the programming screen of the installer password and enter the new password.
4. The system stores the new password as the current password for INSTALLER 1. The user interface returns to the MAIN screen, indicating local programming, followed by a panel reset.
5. Replace the J5 jumper to restore the normal program menu screen functionality.

Power supply

The power supply system of the FC503 & FC506 control panels complies with EN54-4. All models are powered by the mains. The FC503 and FC506 have switching power supply that supplies up to 5.5 A at 27.6V. Both models can house two 12V, 17Ah batteries that when connected in series, supply 24V to the control panel and peripherals in the event of a blackout.

Notes

- If necessary, whether for the full configured loop or for particular system requirements, a user or installer can connect the FC503 and FC506 control panels to two

12V, 38 Ah batteries in an external metal box. See [Figure 16](#).

- The battery must be a VRLA (valve regulated lead acid) type.
- The battery must comply with all applicable standards indicated in paragraph M.2.1 of standard EN 62368-1:2014 "Requirements (safety of batteries and their elements)"; In this case, the battery must comply with the standards: IEC 60896-21:2004 and IEC 60896-22:2004.
- A skilled professional must install and replace the battery.
- The battery must have an enclosure with flammability class UL94V-1 or better.

The control panel can detect, signal, and store in memory the following power faults:

- Shorted 24A or 24R outputs
- Low battery
- Battery fault
- Battery disconnected
- Battery trouble LED
- Ground fault Earth LED
- Mains failure Power Supply Fault LED

The Battery fault may be signaled with a delay up to 1 minute; see [Table 5](#). The Mains (Amber) fault is signaled when the programmed delay expires.

Description of the FC500 repeater signaling

FC500 repeater control keys

Test, **Silence Buzzer** and **Evacuate** control keys can only be activated without a password at access level L1. All other control keys can be activated with a password at access level L2 and L3. See Table 4.

FC500 repeater LED description

[Table 5](#) provides a description of the FC500 repeater LEDs.

Description of the control keys (panel)

You can only activate the **Test**, **Silence Buzzer** and **Evacuate** control keys without a pin at access level 1. You must use a pin to activate all other control keys, at access level 2 and 3.

Silence

Use the **SILENCE** key to restore the Silenceable outputs to standby status. If the control panel operates in Night Mode, Silence remains until the programmed Night Mode Silence time expires; if in Day Mode, Silence remains until you press the **SILENCE** key again. In both modes, Silence status cancels when the system detects a new alarm condition.

Reset

You can only enable the **Reset** key at Level 2 with a pin as the fire panel returns to standby status after the Alarm, Delay to Alarm, Warning and Fault conditions stop. At the end of the Reset time, the system reprocesses any Alarm,









Delay to Alarm, Warning or Fault signal that Reset operations did not clear.

For the **Evacuate, Lamp** or **Buzzer Test, Investigate, Silence Buzzer** keys, see Table 4.

When Reset is running, the command keys are inoperative.

Any FC500 repeaters connected to the panel can carry out resetting the fire panel. It is necessary to use a pin to access level 2 or higher.















Table 4: Description of the control panel and repeater keys

Key	Description
 SILENCE/ RESOUND SOUNDERS	Restores the Silenceable outputs and the loop devices to standby status. Note: The silence status remains until you press the SILENCE key again in day mode; or until the night mode silence time expires in night mode; or until the system detects a new alarm condition.
 RESET	Resets the fire detectors and restores all outputs to standby status
 INVESTIGATION DELAY	Refreshes the delay to alarm time Note: If this key is pressed during delay to alarm, the remaining delay to alarm time is increased with the programmed investigation delay.
 EVAC	Activates the evacuation Note: If you press this key, the system generates an alarm.
 SILENCE BUZZER	Silences the local buzzer on the control panel Note: The buzzer operates every time a new event is activated.
 LAMP TEST	Tests the buzzer and the LEDs Note: If you press this key when the control panel is functioning as intended, all LEDs will be on and the buzzer emits a continuous beep.
 HELP	Explains the information on the LCD display in the different screens Note: An embedded help feature present on the panel LCD display. Note: The HELP key is disabled on the repeater.
 System fault acknowledgement switch	In the case of system fault LED latches, the installer or user must press this switch to identify unintended panel operation. Then, you must press the reset button so the panel returns to its default state. Notes: To access this switch, the installer or user must open the front cover of the panel. The switch is on the left bottom side of the main PCB. This key is not available on the repeater. A System fault LED latches occurs in one of the following conditions: <ul style="list-style-type: none"> • The system resets itself (watchdog reset) when any internal logical fault occurs. • The system is powered ON after a complete panel shut down.

The status LED

Table 5 describes how the control panel LEDs operate. During standby status, only the Green Mains LED and the Day mode LED, if the control panel is in Day mode, should be on.

Table 5: Description of the status LEDs.

LED	Description
	FIRE (Red) ON indicates the alarm status. In the event of an alarm, the control panel activates the unbypassed alarm outputs.
	GENERAL FAULT (Amber) ON indicates the presence of a fault. The following LEDs or the screen display indicates the type of fault. OFF indicates no fault.
	SYSTEM FAULT (Amber) ON ** indicates a blocked control panel and *** indicates the control panel restart. IMPORTANT: Maintenance required. Blinking *** indicates that the data panel programming is corrupted. Note: When the control panel is switched on for the first time, this LED blinks until a reset has been performed. Note: ** indicates the buzzer system fault pattern; *** indicates the buzzer fault pattern. Note: The System fault LED latches if one of the below conditions occurs: <ul style="list-style-type: none"> The system resets itself (watchdog reset) when any internal logical fault occurs. System is powered ON after a complete panel shut down.
	FIRE SIGNAL FAULT (Amber) ON indicates that the communicator is disabled. Blinking indicates that the communicator is faulty.
	POWER SUPPLY FAULT (Amber) ON indicates a mains failure (230 V). Blinking indicates a Switching Power supply fault. During this condition, the control panel is powered by the batteries.
	EARTH FAULT (Amber) ON indicates a voltage leakage to Earth. IMPORTANT: Check wiring insulation.
	BATTERY TROUBLE (Amber) ON indicates that the batteries are empty or faulty. If this condition persists, the batteries are unable to function as intended in the event of a blackout. IMPORTANT: New batteries are required.
	POWER ON (Green) ON indicates that the panel is supplied with power. OFF indicates a mains failure whereby both mains and battery power is lost (the battery disconnect threshold is 19.2 V). Power must be restored before the batteries reach the disconnect threshold.
	MORE INFO (Amber) ON indicates that there is hidden information with lower priority. View List shows the hidden information. OFF indicates no hidden information is available.
	SOUNDERS SILENCED (Amber) ON indicates that the silenceable outputs and loop device have been forced into standby by means of the SILENCE/ RESOUND SOUNDERS key. In day mode, the silence status remains until the SILENCE/RESOUND SOUNDER key is pressed again. In night mode, the silence status remains until the night mode silence time expires or until the system detects a new alarm or a new trouble condition.
	FIRE SIGNAL ON (Red) ON indicates that the transmission was successful. Blinking indicates that the transmission is in progress. On the control panel screen, the connection type, such as PSTN, GSM, or LAN network, is displayed.
	SOUNDERS FAULTS/DIS (Amber) ON indicates that the output is disabled or outputs configured to "act as SC1" are disabled. Blinking indicates that the SC1 is in fault or outputs configured to "act as SC1" are in fault. OFF indicates that all the main sounder outputs (EN54-1, TYPE "C" outputs) function properly.
	DISABLED (Amber) ON indicates the disabled status of any bypassable entity.
	TEST (Amber) ON indicates the test conditions on at least one zone.

☀	DAY MODE (Amber)	ON indicates that the control panel is operating in day mode. OFF indicates that the control panel is operating in night mode.
1-8	SOFTWARE ZONES (Red)	ON indicates that the corresponding software zones are in Alarm status *. Note: * indicates that the zone outside the 1- 8 range does not have a related LED, its alarm status is displayed only by the LCD. Blinking indicates that the corresponding software zones are in Delay to Alarm status.
	CONTROLS ON (Amber)	ON indicates that the control panel is at least at level 2 so the SILENCE/RESOUND SOUNDERS, RESET and INVESTIGATION DELAY keys are enabled.

Note: * the zone outside the 1 to 8 range does not have a related LED, its alarm status is displayed only by the LCD, ** buzzer SYSTEM FAULT pattern, *** buzzer FAULT pattern.

Parts identification

Figure 1: FC503 and FC506 Parts: external view

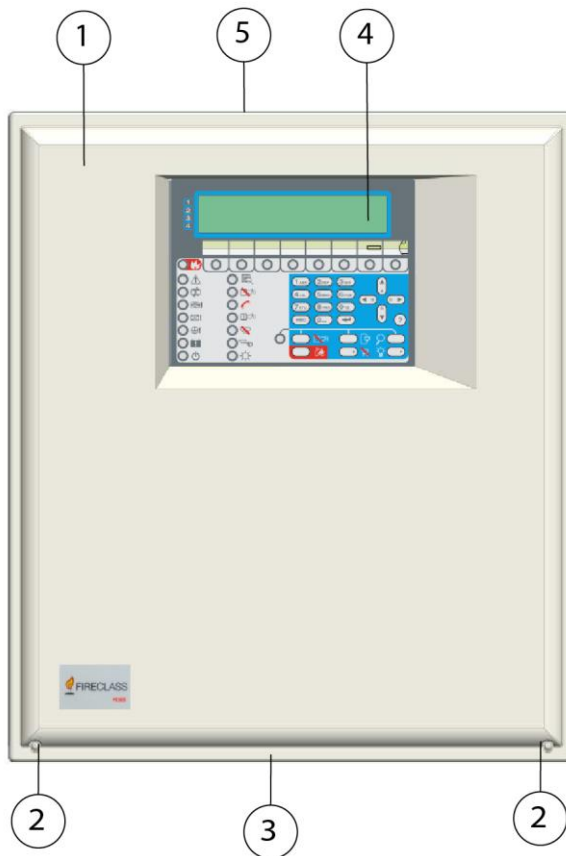

Description of parts

This section describes the components of the FC503 and FC506 control panels.

Unless otherwise stated, the numbers in boldface in this manual refer to the tables and diagrams in this section.

1	FC503 or FC506 cover
2	Screws (2) to close the cover on panel
3	Knockout for connection FC503, FC506 panel with FC500BX battery cabinet (accessory item) (1)
4	Display
5	Knockouts for cables ducted externally (18)

Figure 2: FC503 and FC506 Parts: Internal view

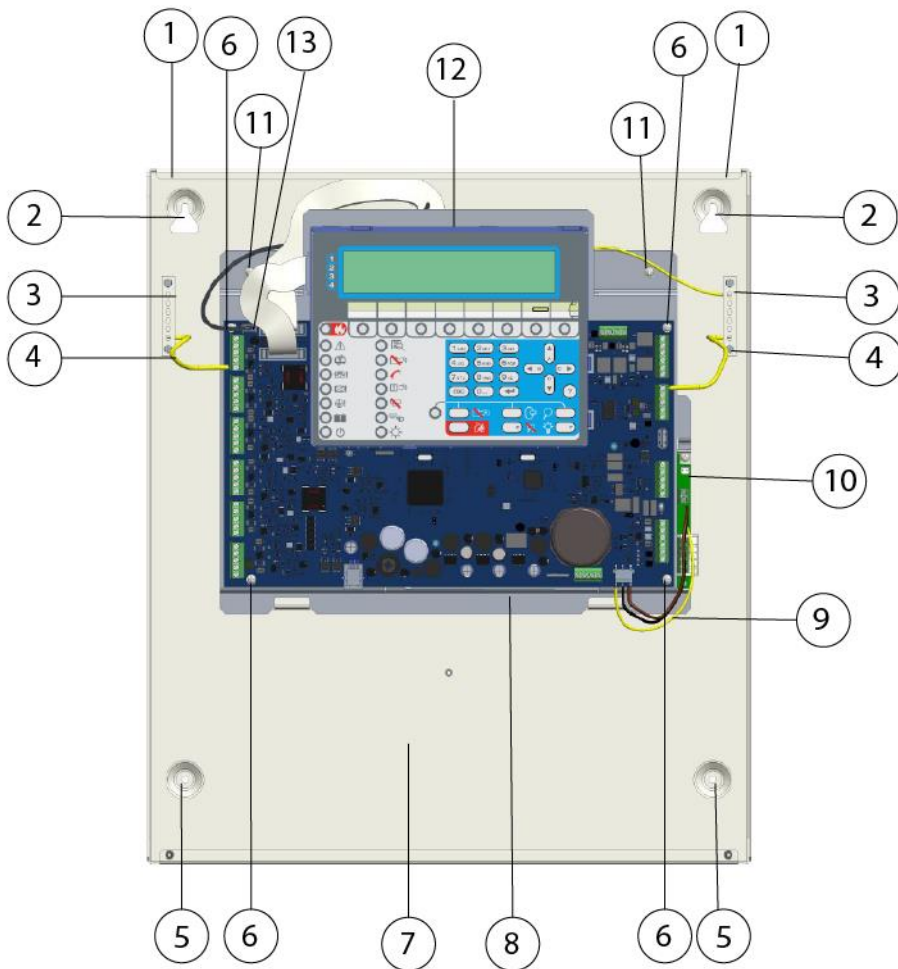

1	Hooks to secure the cover on the panel (2)
2	Panel anchor screw locations (Top) (2)
3	Terminals (2) for the earth connection wires
4	Earthing Cables (2)
5	Panel anchor screw locations (Bottom) (2)
6	Screws to secure main board (4)
7	Location for 2 batteries 12V, 17Ah
8	Metal chassis
9	Power cable for main module
10	Switching power supply (See Figure 4)
11	Screws to secure chassis (2)
12	Main Module (See Figure 3)
13	Serial port RS 232 (PC link)

Figure 3: Main module parts

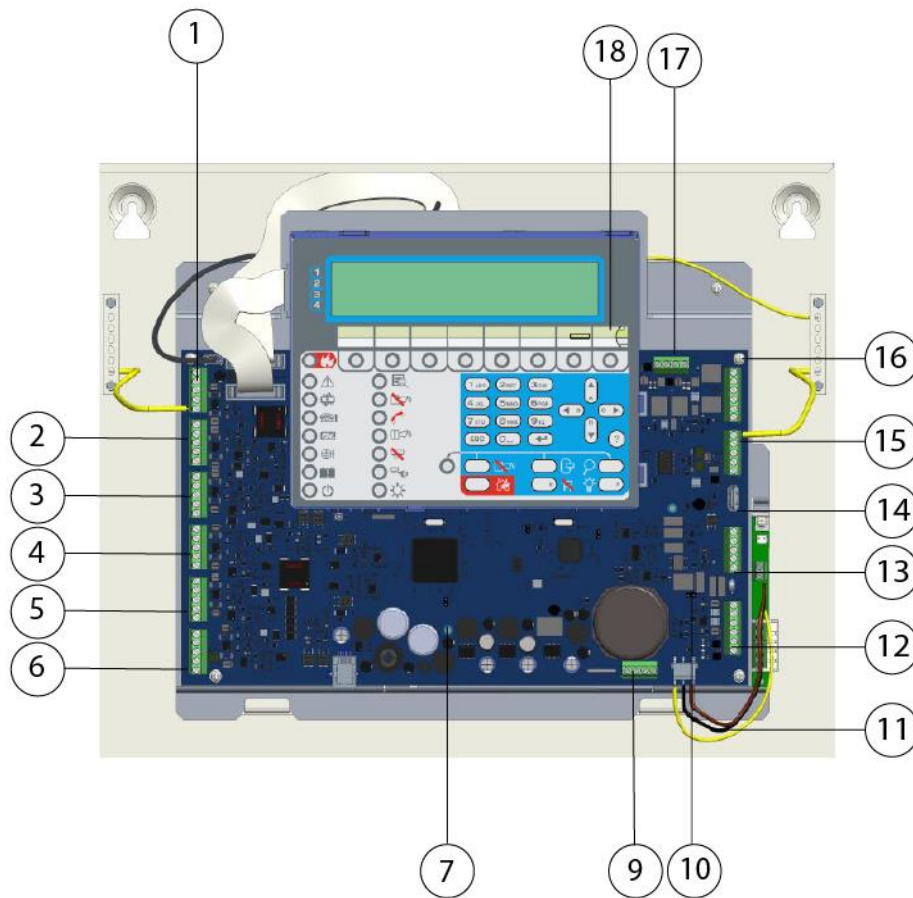

1	Loop 1 (sub loop 1)
2	Loop 2 (sub loop 2)
3	Loop 3 (sub loop 3)
4	Loop 4 (sub loop 4)
5	Loop 5 (sub loop 5)
6	Loop 6 (sub loop 6)
7	Jumper J5 to reset the INSTALLER PIN no.1 to the factory default (00000)
8	Buzzer (not visible)
9	Battery connection terminals
10	Jumper for the exclusion of the Earth Fault: œœ = Earth Fault detected (Default); oo = Earth Fault ignored
11	Power supply main module connector
12	Programmable outputs and auxiliary power supply terminals

13	Terminals for phone line connection
14	USB port
15	RS485 serial port
16	Fire and Fault relay outputs
17	SC outputs
18	Opening to insert the zone location text strip

Figure 4: BAQ140T24 Switching-power-supply

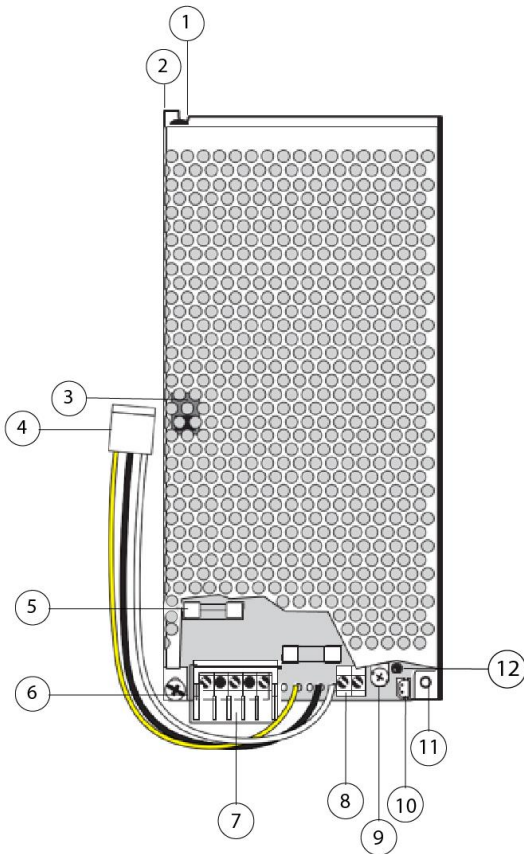

Notes:

- Before connecting the fire control panel to the PC for the PC programming phase, remove the jumper of the main board. See [Figure 3](#), item 10. When the programming phase finishes, replace the jumper to ensure the Earth fault or Leakage to Earth is detected.
- To silence the buzzer permanently during installation, engage the control panel at access level 3 and remove the Jumper J5. See [Figure 3](#), item 7. A disabled buzzer causes the zonal LEDs to flash and a "BUZZER OFF" string displays alternately with the date and time on the panel user interface. As a result of this procedure, the timeout for the installer does not change. To reactivate the buzzer, replace the Jumper J5 when the installation process completes.

1	Switching-power-supply closure rivet
2	Switching-power-supply anchor
3	Voltage switch (230V)
4	Cable: connects the switching power supply to the main board (connected at factory)
5	Switching power supply fuse protects against overload:BAQ140T24 = F 4A 250V
6	Switching-power-supply screws
7	Mains power terminals (230V~ 60/50 Hz)
8	Auxiliary power-supply terminals (27.6 V)
9	Fine trimmer for the switching-power-supply output voltage
10	Thermal probe connector
11	Switching-power-supply anchor hole (2)
12	Mains indicator LED (switching power supply)

Installation



CAUTION

Installation of the control panel must take place strictly in accordance with the instructions in this guide and in compliance with the local laws and bylaws in force.

Prior to commencing the installation of the control panel, take adequate precautions to prevent damage to the sensitive electronic components on the display board and control board due to electrostatic discharge. Discharge any static electricity accumulated by touching a convenient earthed object such as an unpainted, copper radiator pipe. Repeat the process at regular intervals during the installation process.

Installing the control panel

Work carefully through the following steps. See [Figure 1](#) and [Figure 2](#) for further information. Install the FC500IP module before mounting the control panel as described in the paragraph [Installing the FC500IP board](#).



CAUTION

- Place the panel in a clean, dry position where there is no shock or vibration present, and at least 2 meters away from pager systems or any other radio transmitting equipment.
- Separate fire alarm cables from all other wiring unrelated to the fire alarm system.

1. Identify a suitable mounting location on the wall for the control panel.
2. Remove the two screws from the cover and open the control panel. See [Figure 1](#), item 2. Lift the lower part of the cover and push upwards to fully remove the cover from the panel assembly.
3. Disconnect the earth cables at the top left and right of the control panel chassis. See [Figure 2](#), item 4.
4. Remove the chassis, including power supply and control board, from its fixings by unscrewing the screws on the chassis. Remove the top left and right screws completely. Push the chassis upwards and remove. See [Figure 2](#), item 11. Do not remove the power supply or control board from the chassis. Handle the chassis carefully to avoid damage and place it safely to one side.
5. Level and hold the empty cabinet up to the wall. Mark the positions for the four mounting holes on the wall.
6. Drill the holes at the marked positions on the wall. Check for water pipes and electrical wiring before drilling.
7. Insert the top two screws halfway. Hang the panel on

the top two screws and tighten them securely.

8. Insert the bottom two screws and tighten them securely.
9. Refit the chassis using the two resting features at the bottom of the cabinet and the top two mounting screws.
10. Reconnect the earth lead to the main board. See [Figure 2](#), item 6.
11. Insert the installation cables into the cabinet using the cable entry knockouts at the top of the cabinet. Use the knockouts for all the cables and secure the cables through the cable ties. See [Figure 1](#), item 5.
12. When all installation cabling is complete, check the cabling to ensure that it is free from short circuits, open circuits, earth faults, and crossed connections.
13. Program the control panel in accordance with the instructions in the *FC503 & FC506 Addressable Fire Control Panels User Manual* and the *FC503 & FC506 Addressable Fire Control Panels PC Programming Manual*.
14. Test the entire system. Ensure that you test the control panel, detectors, fire warning, and fire control devices.
15. Remove any debris from the cabinet.
16. Attach the cover to the hooks and rotate the cover down to close it. Secure the cover at the bottom with two screws. See [Figure 1](#), item 2.

Figure 5: Chassis mounting details

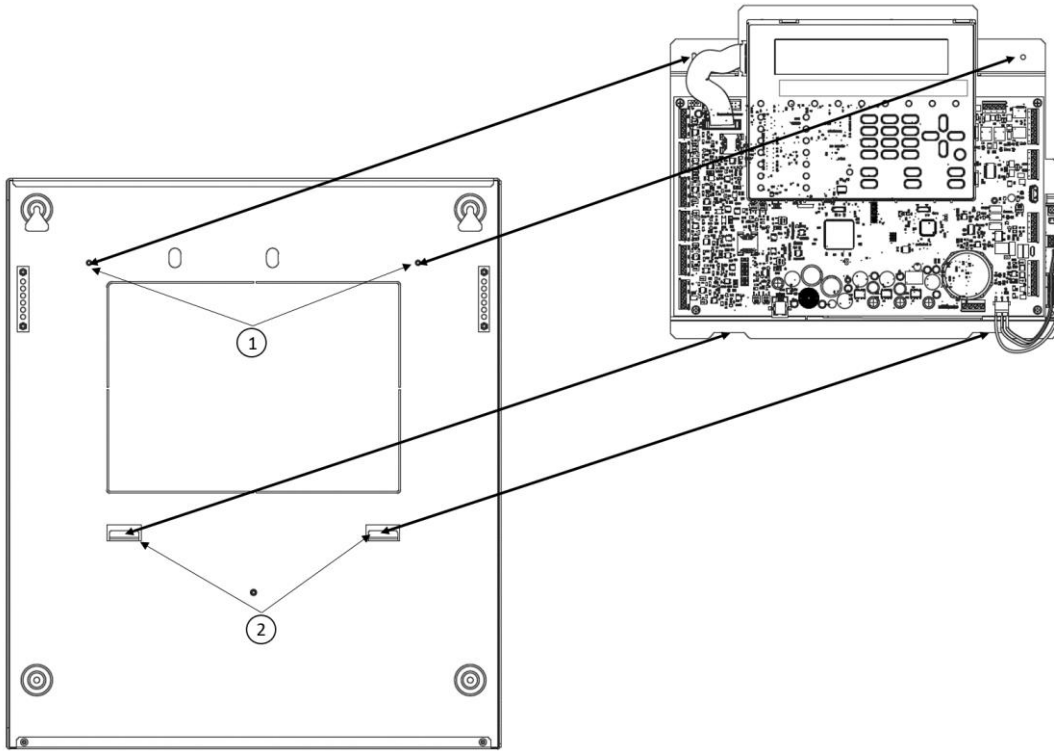

1	Mounting studs
2	Mounting slots

Figure 6: Cabinet dimension details

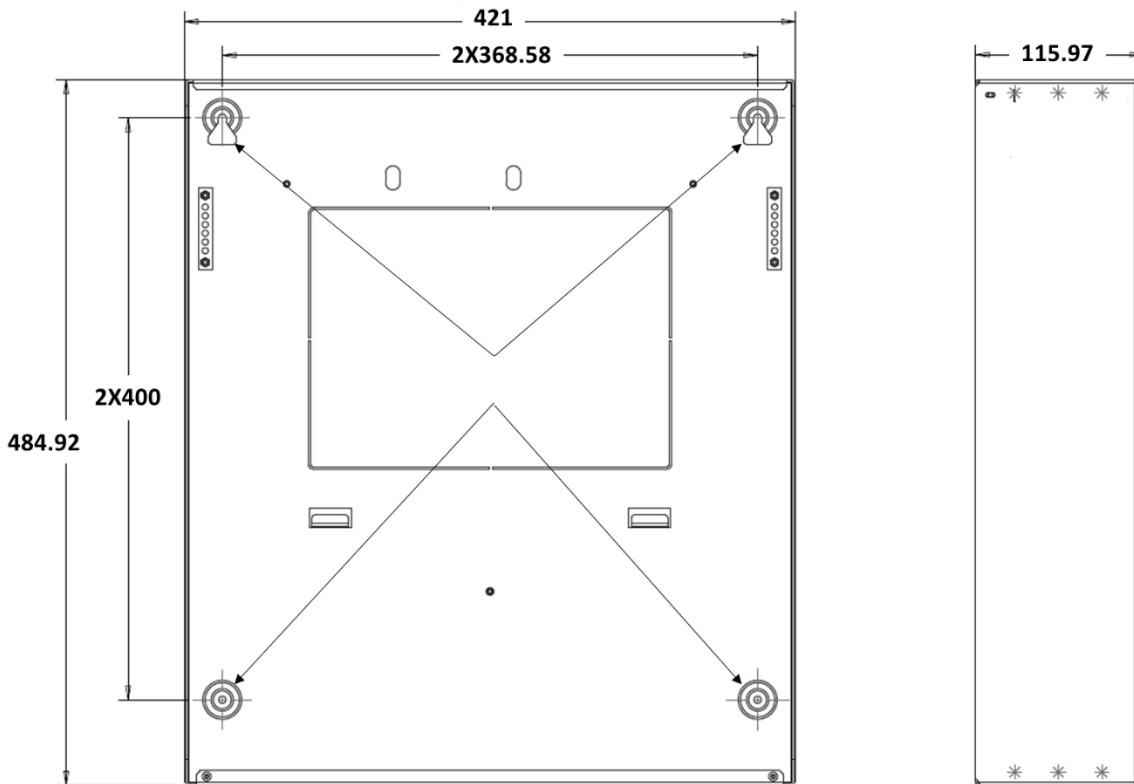

Note: All dimensions are in mm.

1	Mounting holes
---	----------------

Figure 7: FC500 repeater installation

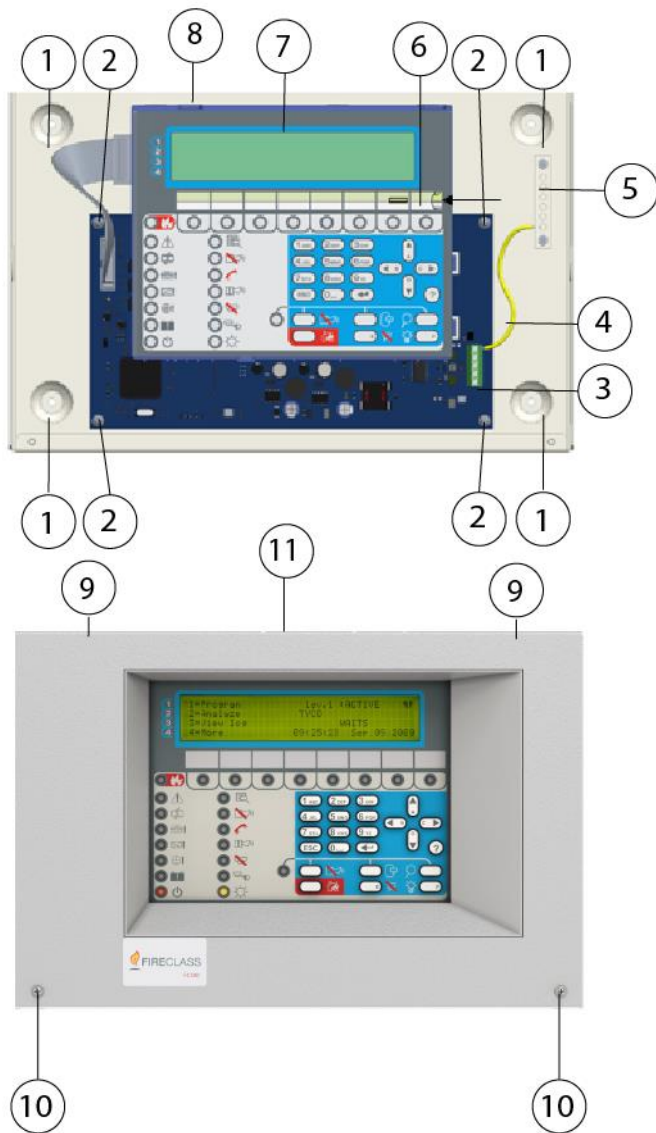

1	Holes for cabinet mounting (4)
2	Screws to secure main module (4)
3	Connector for the repeater RS485 interface
4	Earthing cable
5	Terminal for the earth connection wires
6	LED label slot
7	User interface repeater board
8	Knockouts for cables ducted externally (4) (One on each side)
9	Hooks to secure the cover on the panel (2)
10	Screws to secure cover (2)
11	Repeater panel cover

Inserting the LED and keys labels in the repeater user interface

To insert the LED and keys labels in the repeater user interface, work through the following steps. See [Figure 7](#).

1. Remove the screws, and open the Repeater FC500. Corresponding to the A or B in the overlay, insert the relevant LED and keys Labels. See [Figure 7](#), item 10.
2. Check that the labels are correctly inserted and close the repeater FC500.

Installing FC500 repeater

Repeaters can be wall mounted, or flush mounted to an outlet box or similar.

Follow these steps when installing an FC500 Repeater. See [Figure 7](#).

1. Lay the connection cables. Refer to the section Connecting Repeaters.
2. Remove the screws and open the repeater FC500. See item 10.
3. If you are flush mounting the repeater, go to step 4. If you are wall mounting the repeater, drill the anchor screw holes. See item 1.
4. Pull the wires through the wire entry, then using the anchor screws, secure the repeater to the wall. See item 8.
5. Complete the connections to the terminal board of the RS485 Interface, as described in the [Connecting Repeaters](#) section. See item 3.
6. Connect the earth wire to the threaded support on the board, as shown in [Figure 7](#). See item 5.

Description of the terminals

This section describes the control panel terminals.

FC503

Main loop 1

Loop 1 (sub loop 1)

- +LEFT: Positive signal
- - LEFT: Negative signal (return)
- +RIGHT: Positive signal
- - RIGHT: Negative signal (return)
- SH: Cable shield terminal.

Loop 2 (sub loop 2)

Loop 2 (sub loop 2) terminals are the same as Loop 1 (sub loop 1) terminals.

Loop 3 (sub loop 3)

Loop 3 (sub loop 3) terminals are the same as Loop 1 (sub loop 1) terminals.

Notes:

- The three sub loops of the panel can manage up to 250 addressable devices.
- The maximum current load for the three loops must not exceed 1A.

FC506

Main loop 1

Loop 1 (sub loop 1)

- +LEFT: Positive signal

- - LEFT: Negative signal (return)
- +RIGHT: Positive signal
- - RIGHT: Negative signal (return)
- SH: Cable shield terminal.

Loop 2 (sub loop 2)

Loop 2 (sub loop 2) terminals are the same as Loop 1 (sub loop 1) terminals.

Loop 3 (sub loop 3)

Loop 3 (sub loop 3) terminals are the same as Loop 1 (sub loop 1) terminals.

Main loop 2

Loop 4 (sub loop 4)

Loop 4 (sub loop 4) terminals are the same as Loop 1 (sub loop 1) terminals.

Loop 5 (sub loop 5)

Loop 5 (sub loop 5) terminals are the same as Loop 1 (sub loop 1) terminals.

Loop 6 (sub loop 6)

Loop 6 (sub loop 6) terminals are the same as Loop 1 (sub loop 1) terminals.

Notes:

- The six sub loops of the panel can manage up to 500, maximum of 250 in a single main loop, addressable devices.
- The total length of the cables connected to the three loops must not exceed 2000 m.
- The maximum current load for the three sub loops must not exceed 1A.

Telephone line

LE

Terminals for connecting the external telephone line.

LI

Terminals for connecting the internal telephone line. Connect these terminals to other telephone devices that need to share the same phone line as the fire panel.

There is also a terminal for connecting the earth wire.

Fire

[NC][NO][C]

The following features describe the [NC][NO][C] fire output:

- This is a non-supervised fire output; a dry contact relay for non-supervised devices.
- The fire output activates by default when the first fire event occurs.
- Deactivation of the fire output occurs during the panel reset.
- The fire output may be muted; see the default programmable option=NOT silenceable.
- It is not possible to disable the fire output.
- The fire output may be programmed to work differently,

only with the FC503_FC506 software.

- During standby status, terminal [C] closes to terminal [NC].
- In the event of fire, terminal [C] closes to terminal [NO].

Note: EN54-2 certification applies only when the fire output is not C or J or G (EN 54-1) type. Therefore, you must not use this output to manage fire alarm devices, fire or fault transmission devices, or an automatic fire alarm system.

Fault

[NC][NO][C]

This is a non-supervised fault output; a dry contact relay for non-supervised devices.

The fault output activates when:

- The first fault event occurs.
 - In the case of logic fault.
 - In the case of total loss of power.
- Other features of this fault output include:
- Deactivation of this fault occurs during the panel reset.
 - It is not possible to silence the fault output.
 - It is not possible to disable the fault output.
 - The fault output may not be programmed to work differently.
 - During standby status, terminal [C] closes to terminal [NC].
 - In the event of fault, terminal [C] closes to terminal [NO].

Note: EN54-2 certification applies only when the fault output is not J (EN 54-1) type. Therefore, you must not use this output to manage fault transmission devices.

SC1, Sounder circuit

This sounder circuit is a supervised, silenceable, bypassable or disabled bell output for the alarm signaling devices. Terminals for the connection of devices that are activated with the positive 24V must be supervised.

During standby status, negative pull-down to 0 V on [+] terminal; positive pull-up to 27.6 V on the [-] terminal. When control panel is in alarm status, positive pull-up to 27.6 V on the [+] terminal; negative pull-down to 0 V on the [-] terminal.

Silence the SC1 using the menu command **DISABLE**.

Note: You cannot program this output, it activates every time the control panel goes into ALARM status.

SC2, Sounder circuit

This sounder circuit is a supervised, silenceable, bypassable or disabled programmable bell output, for the panel alarm signaling or panel delay to alarm or panel warning or panel fault or 1,2,3 or 4 software zones(OR) alarm, or 1,2,3 or 4 software zones(OR) warning or 1,2,3 or 4 software zones (OR) fault or 1,2 or 3 points(OR) alarm or 1,2 or 3 points(OR) delay to alarm or 1,2 or 3 points(OR) warning or 1,2 or 3 points(OR) fault.

During standby status, negative pull-down to 0 V on [+] terminal; positive pull-up to 27.6 V on the [-] terminal. When a programmed event occurs, positive pull-up to 27.6 V on the [+] terminal, negative pull-down to 0 V on the [-] terminal.

You can force the SC1 and SC2 outputs to standby by resetting the control panel. The SC outputs hold standby status for the programmed silence time. If alarm conditions are present when the programmed silence time expires for the SC1 or another programmed event for the SC2, they reactivate.

Notes:

- SC1, SC2 accept devices that operate within SELV limits only.
- The SC2 output, if programmed as SC1, is type C.
- If using a 2-wire connection loop, the EN54-2 certification only applies when the total number of devices, including detectors and manual callpoints, does not exceed 32.

Auxiliary outputs

OC1-OC2

These outputs are silenceable, bypassable or disabled, unsupervised and programmable. These are open-collector terminals for the panel alarm signaling (default) or panel delay to alarm or panel warning or panel fault or 1,2,3 or 4 software zones(OR) alarm, or 1,2,3 or 4 software zones(OR) delay to alarm, or 1,2,3 or 4 software zones(OR) warning or 1,2,3 or 4 software zones(OR) fault or 1,2 or 3 points(OR) alarm or 1,2 or 3 points(OR) delay to alarm or 1,2 or 3 points(OR) warning or 1,2 or 3 points(OR) fault, which will be close to ground, when the connected event becomes active, and will remain in this state until the generating event has ended (so after a manual reset or a fault re-store).

You can program the output OC1 to signal the telephone line failure so it can combine with a relay, for switching from the primary phone line to the reserve line.

You can also force the OC1 and OC2 outputs to standby by resetting the control panel.

The OC1 and OC2 outputs activate with a delay equal to the delay to alarm time when the programmed event occurs.

Note: EN54-2 certification applies only when OC1 and OC2 outputs are not C or J or G, EN 54-1 type. Therefore, do not utilize this output to manage the fire alarm device or fire or fault transmission devices or automatic fire alarm system.

24R [GND]

Resettable auxiliary power supply to devices that operate at 24 V, 1A max powered by the following standby batteries:

- Positive (27.6 V) on terminal [24R];
- Negative on terminal [GND].

Note: This power supply disconnects for 2 seconds when resetting the control panel, so it suits devices that restore when the power supply disconnects.

24A [GND]

This is auxiliary power supply for devices that operate at 24 V, 1A max always and guaranteed by the following batteries:

- Positive (27.6 V) on terminal [24A];
- Negative on terminal [GND].

RS485

24V[B|A|GND|SH

These are the terminals for the FC500 repeater, (maximum 8) and the FC500MFI module (maximum 4, 1A max). Types of terminals include:

- Serial bus terminals [A] and [B];
- 27.6 V power voltage terminals [GND] and [24V].

Note: The maximum cable run allowed is 1000m.

Battery

+BAT-

Terminals to connect the batteries inside the FC503, FC506 control panel.

The system wiring

Internal and external wiring:

Note: If you use conductors with a total cross-sectional area of 0.5 mm² or greater, use the procedure found in the IEC 60332-1-2 and IEC 60332-1-3 standards.

If you use conductors with a total cross-sectional area of less than 0.5mm², use the IEC60332-2-2 standard.



CAUTION

Bunch high voltage leads (230V) separately from low voltage leads (24V). Bunch leads in a way that avoids contact with other wiring and components.

Note: Use only shielded cable for all connections, with one end connected to the SH terminal of the control panel and the other one left free.

Connecting addressable devices

The control panel FC503 has one main loop or three sub loops for addressable analogue devices. The control panel FC506 has two main loops or six sub loops for addressable analogue devices. The maximum number of connecting addressable devices for one main loop is 250 addressable analogue fire detectors and analogue devices such as input modules and output modules.

Every detector and module connected to the loops must have a unique address. You can use two or four wires for the loop connections.

Specify the loop connection type during the programming phase. The following figures illustrate the loop connections:

- [Figure 8](#) illustrates the 2-wire connection to Loop 1.
- [Figure 9](#) illustrates the 4-wire connection to Loop 2.

Whatever the type of connection performed, ensure that any short or open circuit in the wiring does not lead to the loss of more than 32 detectors. It is necessary to fit an isolator every 32 detectors.

If using a 2-wire connection type, you can connect addressable analogue fire detectors and analogue devices such as input and output modules on the left and right sides. There are two spur circuits per sub loop

Figure 8: Wiring diagram of a 2-wire connection

A) Isolators;

B) Compatible analogue devices (Fire detector, Input modules, Output modules, Manual callpoints);

C) T connection.

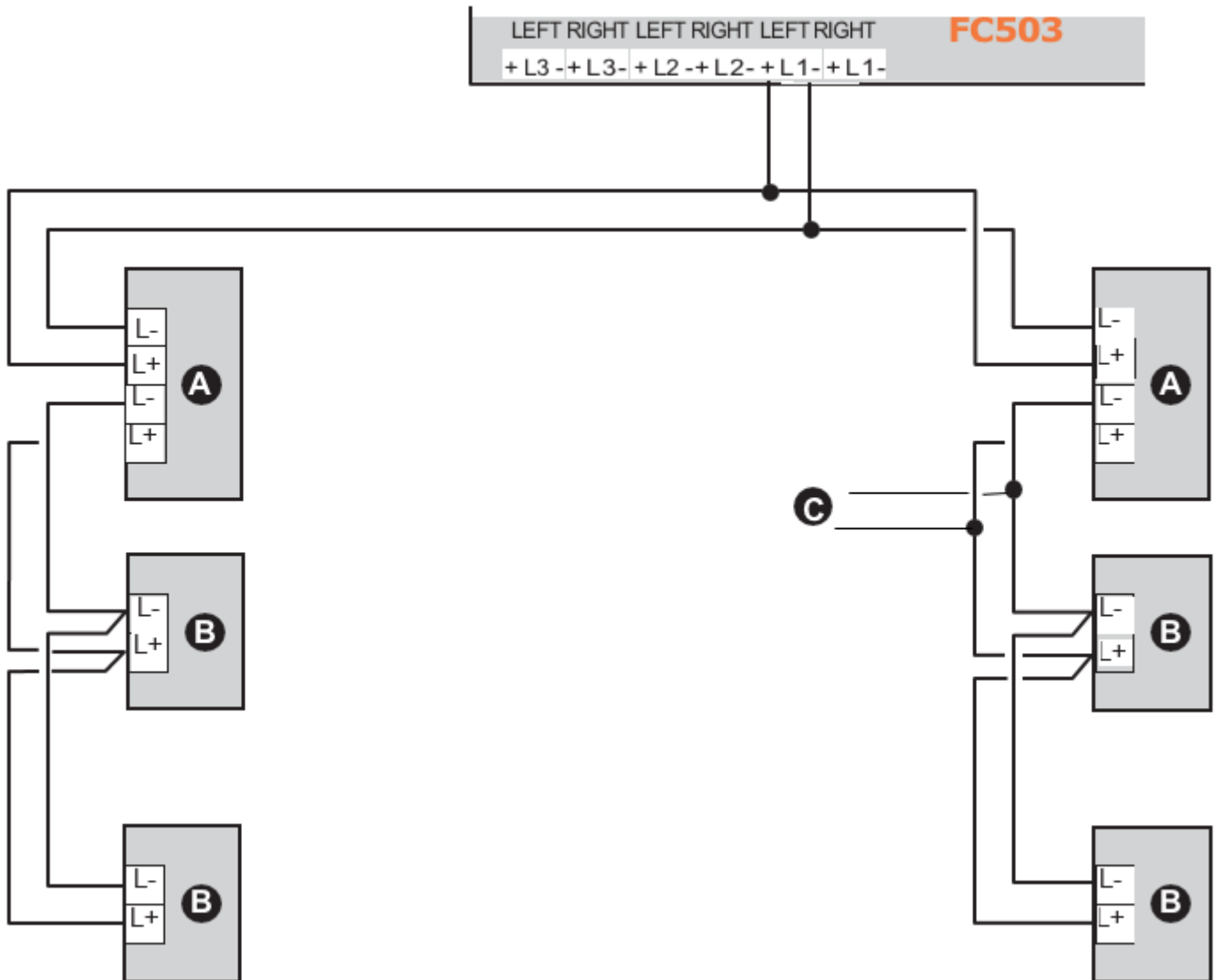

Connecting repeater FC500

For an example of how to connect two FC500 repeaters, see [Figure 10](#). The RS485 port of the FC503, terminals [GND], [A], [B] and [24V], accepts up to eight FC500 repeaters. Terminals [A] and [B] supply the power (27.6 V) to the repeater panels.

When a mains fault occurs, the repeaters decrease the absorbed power, switching off the LCD display backlighting; by pressing a key, the LCD display backlighting switches on again for 20 seconds. However, the absorption of the repeaters continues to run down the backup batteries and decrease the stand-by supply time of the system.

As there is only one control panel in the system, it must supply the repeaters with power, unless a power supply station is in the system.

Use only shielded cable, with one end connected to the earth terminal of the control panel and other left free; secure the continuity between several segments of connection.

Figure 9: Wiring diagram of a 4-wire connection

A) Isolators

B) Compatible analogue devices (Fire detector, Input modules, Output modules, Manual callpoints)

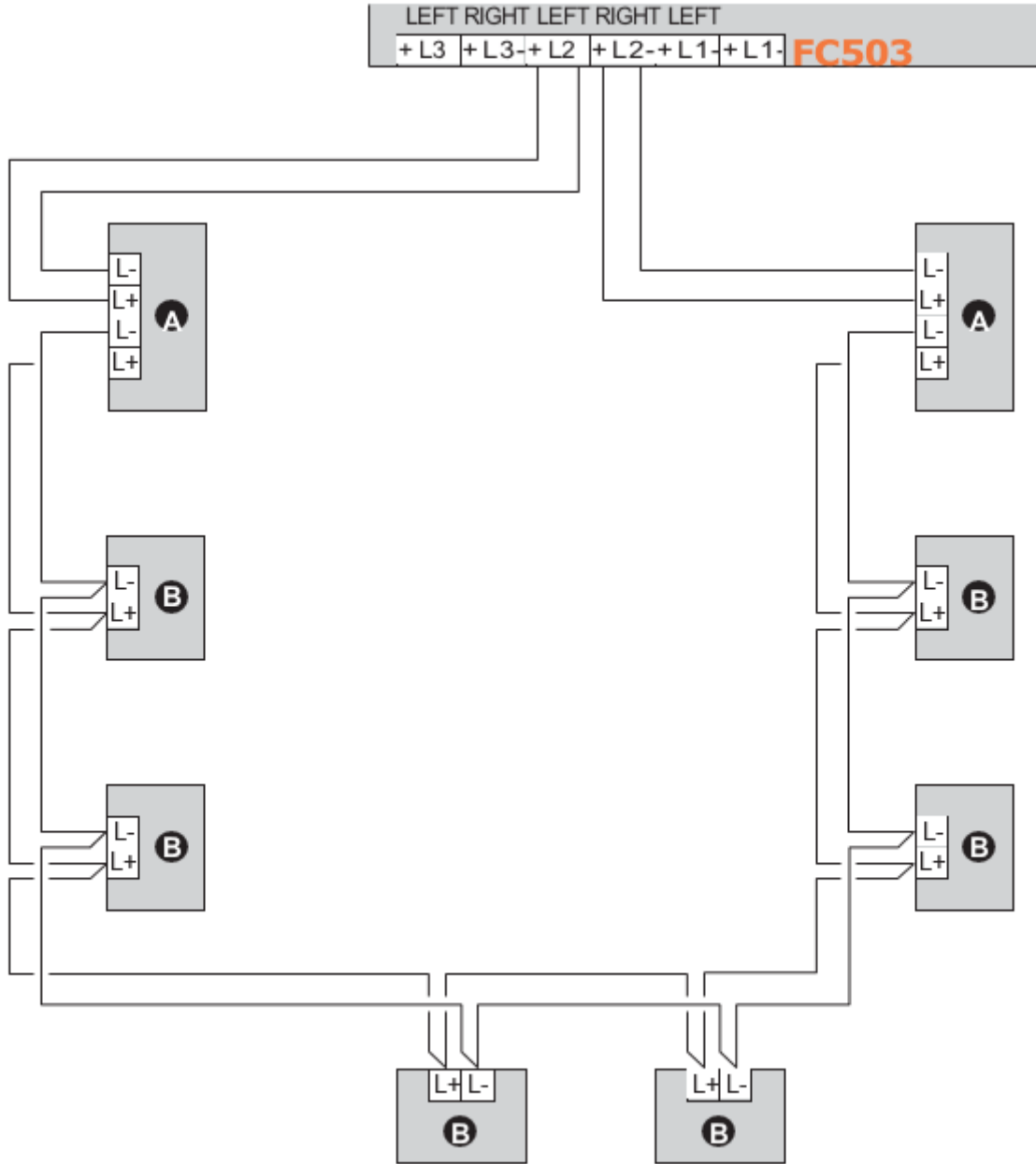

Figure 10: Wiring diagram of eight (max) FC500 repeaters connected to the RS485

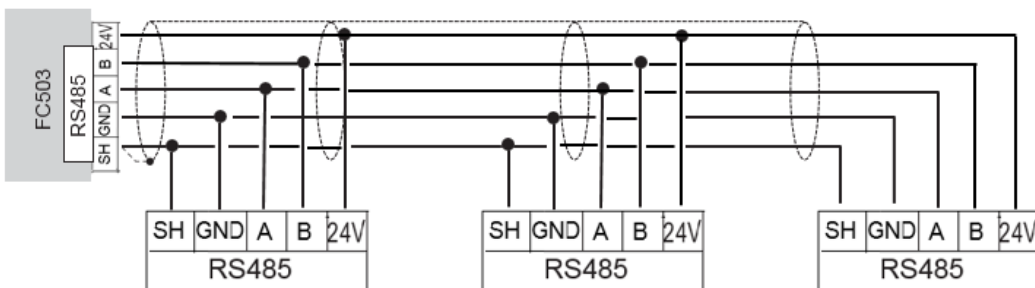
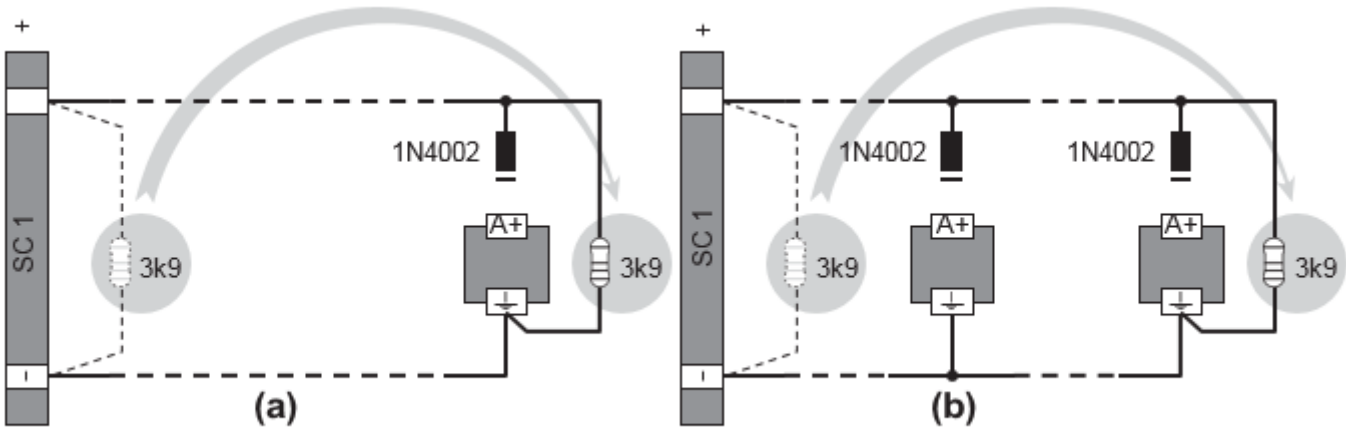

Figure 11: Wiring diagram of the connection of a single device

- (a) Connecting to several devices
- (b) Connecting to bell outputs (device activated by positive (27.6 V) on terminal [A+])



Connecting output devices

The control panel has non supervised outputs and two bell outputs.

Connect output devices to the loops using output modules.

Bell outputs

The bell outputs are indicated by the letter SC and their address number.

The SC1 and SC2 bell outputs are supervised, silenceable, and bypassable or disabled. SC2 is also programmable.

Force the bell outputs to standby using the **SILENCE** button. Once a user acknowledges an alarm, you can silence the audible signaling devices and leave the visual signaling devices active until alarm conditions cease.

For example, a connection similar to the wiring diagram in [Figure 12](#) activates the flasher, the bell and the visual and audible signaling device of the self-powered siren in alarm conditions.

Using the **SILENCE** button stops the horn, but not the flasher, which continues to signal alarm status until you press the **RESET** button.

Figure 12: Wiring diagram: Non-silenceable and silenceable output connections

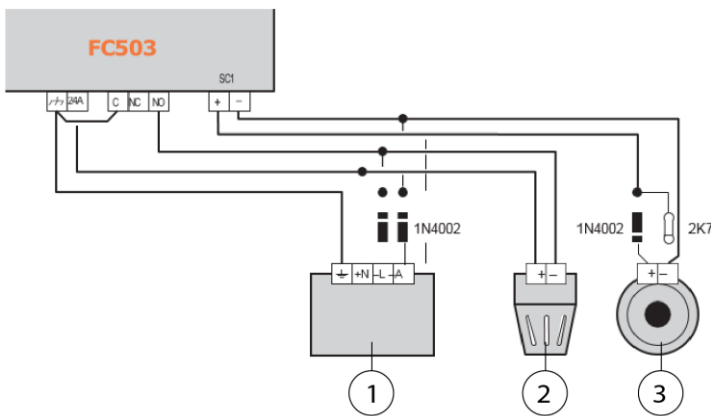

1	Self-powered siren CALL-R24
2	Flasher
3	Bell

Connecting the power supply

The power circuits of this control panel comply with the EN54-4 standard.



CAUTION

In order to comply with the safety regulations in force, the mains must be equipped with a bipolar isolating device for protection against over voltage and short-circuit to Earth. Example: automatic isolating switch.



DANGER

C.I.E in overvoltage category II. If C.I.E is subjected to transient voltages that exceed those for its design overvoltage category, it requires additional transient voltage protection to be provided external to the equipment.

Pollution degree: PD2

This control panel is powered from the Mains (230 V~ 60/50 Hz) through a switching power supply, located inside the case. The FC503 and FC506 control panels provide housing for two 12 V, up to 17 Ah batteries inside the panel or two 12 V, 38 Ah in an external metal box for power during Mains failure. See [Figure 16](#).

Notes

- The battery must be a VRLA (valve regulated lead acid) type.
- The battery must comply with all applicable standards indicated in paragraph M.2.1 of standard EN 62368-1:2014 "Requirements (safety of batteries and their elements)"; In this case, the battery must comply with the standards: IEC 60896-21:2004 and IEC 60896-22:2004.
- A skilled professional must install and replace the battery.
- The battery must have an enclosure with flammability class UL94V-1 or better.

The non-volatile memory holds the programmed data at all times. In the event of MAINS failure, the AMBER Power Supply LED turns ON.

The control panel checks the batteries at all times. In the event of low battery, no Battery or any battery related fault, the Battery Trouble LED turns ON. If this occurs, the Mains power restores before the batteries empty, otherwise the system shuts down.

Connecting the mains supply



CAUTION

Do not allow the power cable to cross over other wiring. The power cable must be routed and held firmly in place by a two cable tie. See [Figure 2](#).

Follow the below steps to connect the Mains Supply:

1. Locate the backup batteries in the cabinet. See [Figure 2](#). Secure the batteries to the panel of the

panel, using the cable ties, in the appropriate opening.

2. Using the jumper supplied, connect the batteries in series.
3. Observing the battery polarity, connect the battery terminals to terminals -BAT+ on Main Board. Wires are supplied.
4. FC503 and FC506 use 17 Ah or 38 Ah @ 12 V Power Sonic batteries or similar.
5. Connect the switching power supply BAQ140T24 with the external power supply (mains). Connect the **Earth** wire to the terminal 7 on the main board. See [Figure 4](#).
6. Connect the **Neutral** wire to terminal [N], and the **Live** wire to terminal [L] on the terminal block 7. See [Figure 4](#).
7. Connect the connector or cable 4 in [Figure 4](#) to the main board connector 9 in [Figure 2](#). The control panel resets on power up.

Figure 13: Wiring diagram for the power supply

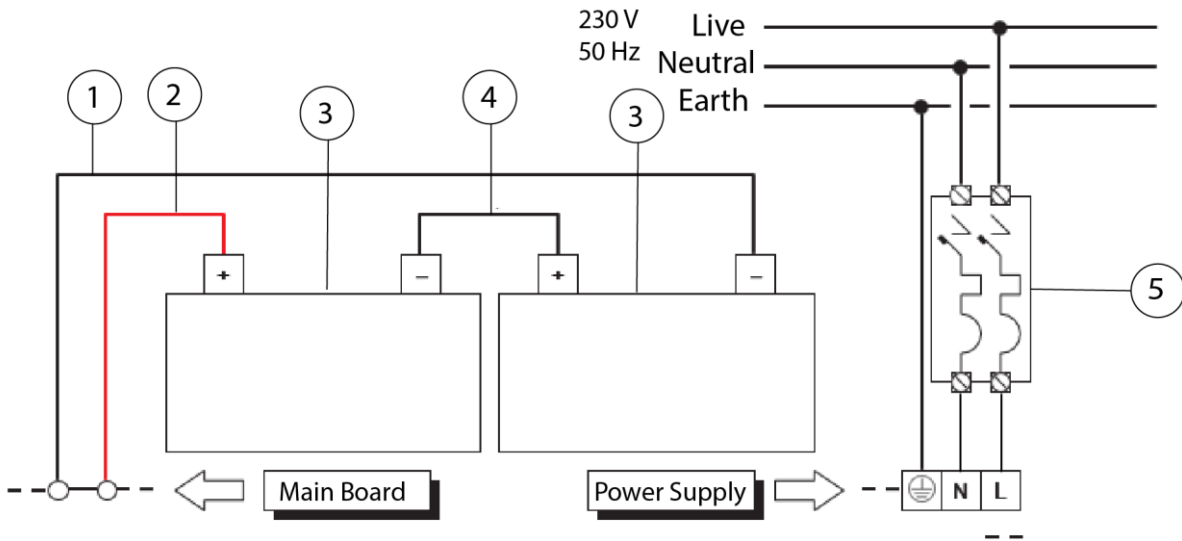

1	Black wire
2	Red wire
3	Battery 12V
4	Jumper
5	Automatic Isolating Switch

panel main board.



CAUTION

Before removing the probe, disconnect the battery from the main board. Removing the thermal probe causes the switching power supply voltage to rise to 27.6 V or greater. This damages the battery.

Thermal probe

The control panel supports the KST thermal probe. The probe optimizes the battery charging process by regulating the charge voltage in accordance with the battery temperature.

Work carefully through the following instructions. Refer to Figures 13, 14 and 16.

Connecting the thermal probe to the control panel

Note: The panel comes with a KST thermal probe installed to connector 10 on the power supply. See Figure 4.

1. Use the trimmer 9 in Figure 4 to adjust the voltage. Refer to the graph in Figure 14 and Table 6. For example: if the probe is located in an ambient temperature of 20°C, the output voltage must be 27.489V.
Important: The probe temperature must be considered during voltage adjustment.
2. Once the voltage adjustment is complete, attach the thermal probe to the battery. Refer to Figure 16. This will provide an optimum level of thermal conductivity.
3. Connect the batteries to the battery terminal on the

If you are disconnecting the battery and you are required to work without the thermal probe (EN54 approval will be lost), adjust the switching power supply output voltage using the trimmer (46) as per Table 6. Reconnect the batteries only if their voltage equates to 27.6 Vdc or less.

To verify battery efficiency, the charger circuit measures the internal resistance of the batteries. To ensure you receive an accurate reading, use only the cables supplied; longer cables or those that have an insufficient section may incorrectly simulate an inefficient battery.

Figure 14: Switching power supply output voltage graph

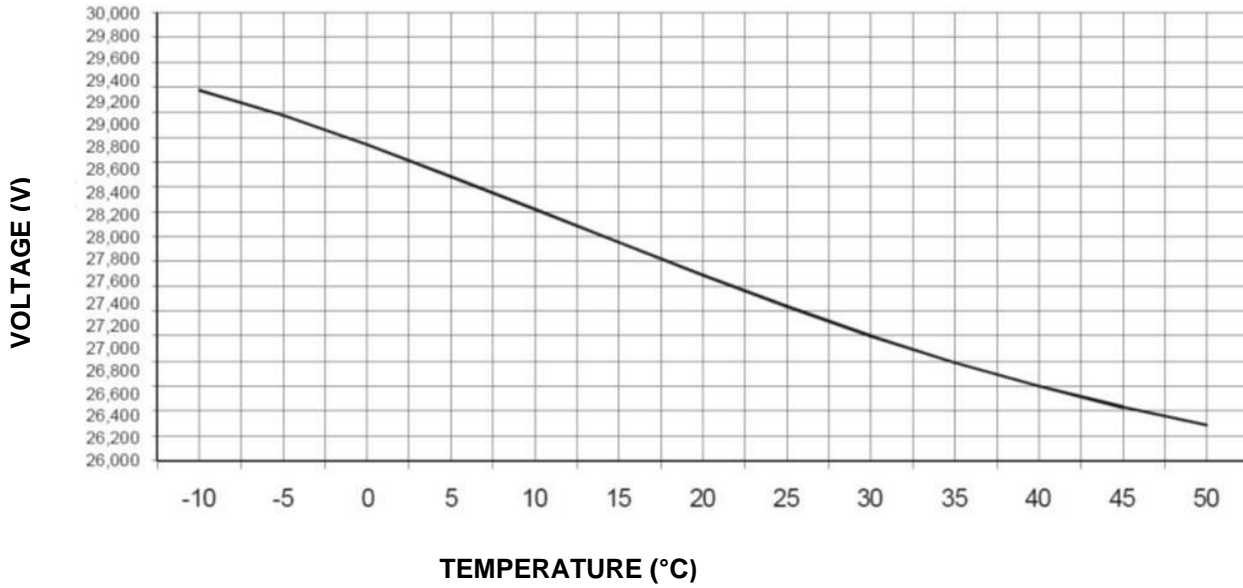

Finding the output voltage using the graph

1. Indicate the probe temperature on the TEMPERATURE (°C) axis.
2. Draw a line from the temperature value point up to the curve **a**) and draw a line from the intersection point across to the VOLTAGE (V) axis.
3. Adjust the output voltage of the switching power supply to the resultant value. For example, if the probe temperature is 22°C, the output voltage of the switching power supply must be set at 27.4 V.

Table 6: Switching power supply output voltage chart

TEMPERATURE (°C)	-10	-5	0	5	10	15	20	25	30	35	40	45	50
VOLTAGE (V)	29.980	28.770	28.537	28.283	28.018	27.752	27.489	27.240	27.002	26.788	26.597	26.428	26.282

Finding the output voltage using the chart

1. Select the nearest value to the probe temperature on the TEMPERATURE (°C) row.
2. Read the respective value on the VOLTAGE (V) row.
3. Adjust the output voltage of the switching power supply to the indicated value. For example, if the probe temperature is 22 °C, the output voltage of the switching power supply must be set at 27.4 V.

Installing the FC500IP board

Install the IP module into the base of the control panel, as shown in [Figure 15](#). Follow these instructions to install the FC500IP board.



CAUTION

- Before installing the FC500IP Module, disconnect the control panel from its power supply, the mains, and the batteries.
- You must connect the IP module to the earth of the electricity supply system.
- You must insert the earth cable (item 10) between the fixing bracket of the module, the screw (item 5) and the earth terminal (item 11).

Figure 15: FC503 connection with the FC500IP

Do not remove the wiring already present on the screw (item 11).

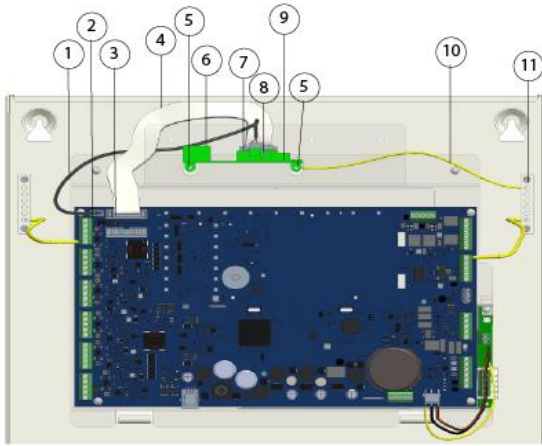

1. Open the control panel by unscrewing the two screws, then lift the cover from the bottom to separate it from the chassis. See [Figure 1](#), item 2.
2. Remove the fastening screw between the control board and the chassis. See [Figure 2](#), item 6.
3. Unlock the control board support and user interface using a flat screwdriver.
4. Lift the control board and user interface display from the base.
5. Insert the IP module below the chassis and align the mounting holes given.
6. Put the IP module screws through the holes on the chassis. See [Figure 15](#), item 5.
7. Assemble the control board again in place with the help of four screws. See [Figure 2](#), item 6.
8. Re-fit the control board and display and secure

the screw.

9. Connect the IP module connector ([Figure 15](#), item 8) to the control panel connector (item 3) using the supplied flat cable (item 4).
10. If you only need to manage the control panel through the IP, connect the IP module connector ([Figure 15](#), item 7) to the control panel connector (item 2) using the supplied PC link cable (item 1).
11. Connect the cable (item 10) between the screws (item 5) and (item 11). See [Figure 15](#).
12. Connect the Ethernet connector ([Figure 15](#), item 6) to the LAN using an Ethernet cable.
Note: Use a category 5 or greater Ethernet cable, STP, or FTP.

1	PC Link cable
2	Serial port RS 232 (PC LINK)
3	Module IP (FC500IP) connector
4	Flat cable for the connection with FC500IP
5	FC500IP fixing screws
6	Ethernet connector
7	PC Link connector
8	Flat cable connector
9	FC500IP board
10	Cable for earth wiring of the FC500IP
11	Earth Terminals

13. Reconnect the control panel to the power supply.
14. Program the IP Module as described in the section PC Programming.

Installing the 38Ah battery metal box

Work carefully through the following steps for the FC503 and FC506 fire panel only. See [Figure 16](#).

1. Remove the two screws on the cover and open the metal box.
2. Drill the anchor screw holes. Check for water pipes and electrical wiring before drilling.
3. If necessary, using a hammer or similar tool, remove the surface conduit wire knockouts of the metal box.
4. Secure the metal base to the wall.
5. Secure the cable conduit union with the cabinet using HB Flame Class or higher lock nuts. See [Figure 16](#).
6. Pull the wires through the cable entry and connect them as shown in [Figure 16](#). See the [Connecting the power supply](#) section.

Maintenance

To ensure the system operates normally, you must carry out regular testing and an installer must provide periodic maintenance in accordance with local laws.

For the maintenance of other devices such as detectors and modules, follow the dedicated instructions for the devices.

Users must carry out the following operations regularly:

- Use a damp cloth to remove dust from the control panel cabinet. Do not use solvents of any kind.
- Using the **Lamp Test** key, check that the LEDs and buzzers function properly.

The following operations must be carried out regularly by qualified persons only:

- Ensure that the batteries are sufficiently charged and functioning properly. If not, replace them immediately.
- Ensure that all cables and connections are intact.
- Ensure that there are no unrelated objects inside the control panel case.
- Ensure that the control panel can process a fire alarm and operate the regular sounders and outputs subsequent to a fire alarm incident. If there is a facility for transmitting fire alarm signals to a central station, ensure that signal comes through correctly.

Verifying the functionality of the circuit

The purpose of verifying the circuit's functionality is to ensure the circuit can detect faults.

1. Connect one of the loops' SH terminals to the ground.
2. Verify that the fire panel correctly reports the fault
3. Remove any connection points previously made.

Figure 16: Control panel and 38Ah Batteries metal box connection (accessory item)

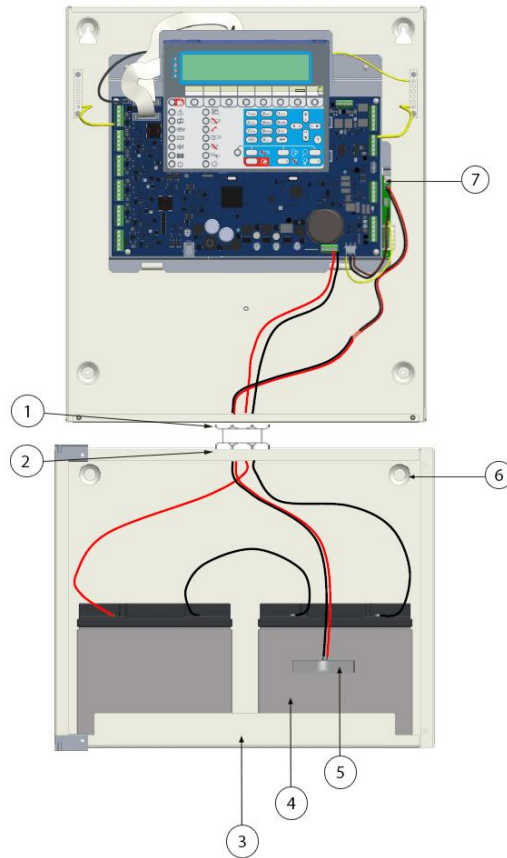

1	Nuts on Control Panel
2	Nuts on 38Ah Batteries cabinet
3	38Ah Batteries cabinet (Accessory item)
4	38Ah Batteries
5	Thermal probe
6	Holes for cabinet mounting
7	Connector for Thermal probe connections

Programming from the panel

The following section provides an overall view of using the user interface programming (main panel) of the control panel.

For PC Programming help, refer to the *FC503 & FC506 Addressable Fire Control Panels PC Programming Manual*.

Using the system

Manage the FC503 and FC506 systems from the user interface (main panel) or through the FireClass FC500 (FC501_FC503_FC506) Console application. The user interface (main panel) allows access to three authorized access levels. The three access levels are:

- Level 1 (lev.1 or L1)** allows read-only access to the parameters.
The options included in lev.1 are:

 - ANALYZE** key views the status of the: LOOP, DEVICE, SW ZONES, OUTPUT, NETWORK, TELECOM, OPTIONS, LOG, FW Vers., and PANEL
 - View LOG**
 - View lists** key views the lists of: DIS. ZONES, DIS. DEVICES, DIS. PARTS, WALK TEST, FAULTS, WARNINGS and Dev. in TEST
- Level 2 (lev.2 or L2)** is referred to as the User Level. To access L2 enter the USER PIN (Access Level 2). L2 includes all the operations of L1 and access to the **MODIFY** and **DISABLE** keys.
The additional options included in L2 are:

 - MODIFY** key for: Init MSG (MESSAGE), L2 USER PASSWORD, DAY/NIGHT, TIME and DATE, CLEAR LOG and WALK TEST
 - DISABLE** key for: DIS LISTS, SW ZONES, OUTPUT, NETWORK, COMMUNIC, FIRE RELAY

Note: Disable Devices, User Passwords and Sounders are only possible at L3
- Level 3 (lev.3 or L3)** is also referred to as the Installer Level.
To access L3 enter the INSTALLER PIN (Access Level 3).
L3 includes all of the operations of L1 and L2 and you can also program the system from L3. The programming phase allows you to program the control panel and peripheral devices including detectors, modules, and repeaters in detail.
The additional options included in L3 are:

 - AUTO, DEVICES, SW ZONES, OUTPUTS, NETWORK, MAP DEVICE, USB, SYSTEM, DEFAULT, and L3 PWD.**

Note: This section shows the operations managed at L3 (Installer Level). Refer to the *FC503 & FC506 Addressable Fire Control Panels User Manual* for further details about the operations managed at L1 and L2 (User Level).

Operating the system from the panel

Use the alphanumeric keypad, the cursor keys, the **ESC** key, and the **ENTER** key to manage the system from the user interface (main panel).

Alphanumeric keypad

Use the alphanumeric keypad to create labels and enter data and codes. The alphanumeric string cannot exceed 20 characters.

Each time the alphanumeric key is pressed in the selected position, pointed by the cursor, the characters printed on the key will appear in sequence and cyclically.

Table 7: Alphanumeric keypad functions

Key	Sequence
1	ABC1
2	DEF2
3	GHI3
4	JKL4
5	MNO5
6	PQR6
7	STU7
8	VWX8
9	YZ blank 9
0	blank 0

Note: Long press (press for more than 1 s) the **0** key to clear the entered data and return the cursor to its starting point.

Cursor keys

Table 8: Cursor keys functions

Key	Function
Up	Use for upper-case letters
Down	Use for lower-case letters
Right	Use to scroll along the line
Left	Use to scroll along the line

ESC and ENTER keys

Table 9: ESC and ENTER key functions

Key	Function
ESC	Use to cancel the operation and return to the previous screen
ENTER	Use to confirm the entered text and proceed or use in the MAIN screen to signal a local programming activity followed by a panel reset

Assistant text composition

To simplify the entry of text strings, an assisted procedure has been included, based on a pre-compiled list of 128 vocabulary words with a maximum of 18 characters. When one of the numeric keys is pressed to enter a letter, the first word in the list that begins with that letter will be inserted. The **Up** and **Down** arrows will load the next or the previous word in the list.

Activate the assisted entry procedure by pressing the **Up** key for more than 3 seconds. Deactivate the assisted entry procedure by pressing the **Down** key for more than 3 seconds. See [Figure 17](#).

Figure 17: Assisted entry procedure

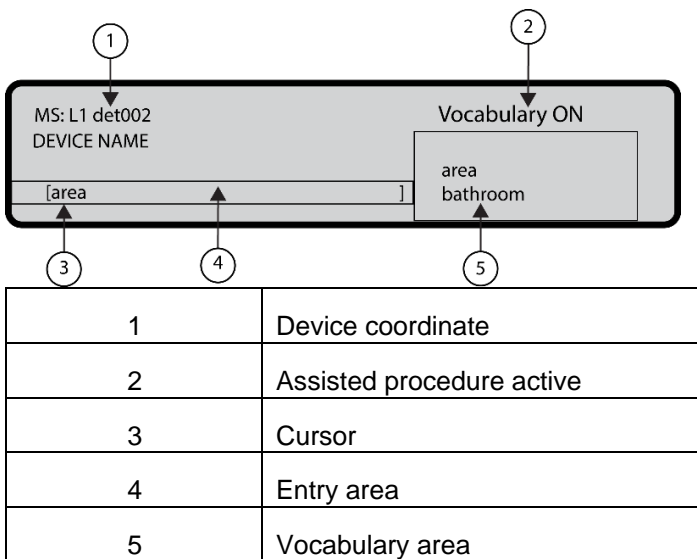

When the assisted entry procedure is active, the string Vocabulary ON blinks on the upper right area of the LCD display. In the Vocabulary area the word currently selected, in the row aligned with the Entry area, is displayed. The word that precedes it in the vocabulary is displayed in the upper row while the next word is displayed in the lower row. In the Entry area the words used to compose the label are displayed.

To enter a word, press the numeric key (more than one time if necessary) related to the first letter of the word that needs to be entered. If this word is not correct, scroll through the vocabulary using the **Up** and **Down** keys until a suitable word is found. During the vocabulary scan, the word in the middle row is entered in the Entry area at the cursor position. Use the **Left** and **Right** keys to move the cursor to the beginning of each word.

Single selection

Use single selection to select a single value between a set of possible values. The maximum number of values is 8.

ON off
^

The selected value is displayed in upper case. The selection of a new value will automatically deselect the previously selected value.

In this phase the keypad and keys have the following functions:

Alphanumeric keypad

No function is related to the alphanumeric keypad.

Cursor keys

Table 10: Cursor key functions in single selection

Key	Function
Up	No function
Down	No function
Right	Use to move the cursor to the next value position and select the value pointed to.
Left	Use to move the cursor to the previous value position and select the value pointed to.

ESC and ENTER keys

Table 11: ESC and ENTER key function in single selection

Key	Function
ESC	Use to cancel the operation and return to the previous screen
ENTER	Use to accept the programmed string. The user interface moves to the next programming parameter screen, if any, or returns to the MAIN screen signaling a local programming activity followed by a panel reset.

Multiple selection

Use multiple selection to select more than one value between a set of possible values. The maximum number of values is 8.

SUN mon tue wed thu **FRI SAT**

^

The selected values are displayed in upper case.

In this phase the keypad and keys have the following functions:

Alphanumeric keypad

No function is related to the alphanumeric keypad.

Cursor keys

Table 12: Cursor key functions in multiple selection

Key	Function
Up	No function
Down	No function
Right	Use to move the cursor to the next value position and select the value pointed to
Left	Use to move the cursor to the previous value position and select the value pointed to

ESC and ENTER keys

Table 13: ESC and ENTER key function in multiple selection

Key	Function
ESC	Use to cancel the operation and return to the previous screen
ENTER	Use to accept the programmed string. The user interface moves to the next programming parameter screen, if any, or returns to the MAIN screen signaling a local programming activity followed by a panel reset

Date and time

Use date and time to enter the date and time.

The default format for date and time is:

hh: mm: ss dd/mm/yy

^

It is also possible to enter the date and time in the alternative time format:

hh: mm: ss mm/dd/yy

^

In this phase the keypad and keys have the following functions:

Alphanumeric keypad

Use the alphanumeric keypad to enter the date and time numeric value.

Note: Long press the **0** key to clear all the entered data.

Cursor keys

Table 14: Cursor key functions in date and time

Key	Function
Up	No function
Down	No function
Right	Use to move the cursor to the next digit position
Left	Use to move the cursor to the previous digit position.

ESC and ENTER keys

Table 15: ESC and ENTER key function in date and time

Key	Function
ESC	Use to cancel the operation and return to the previous screen
ENTER	Use to accept the programmed string. The user interface moves to the next programming parameter screen, if any, or returns to the MAIN screen signaling a local programming activity followed by a panel reset.

Numeric entry

Use numeric entry to enter numeric data up to 20 digits.

[^]

^

In this phase the keypad and keys have the following functions:

Alphanumeric keypad

Use the alphanumeric keypad to enter the numeric value.

Note: Long press the **0** key to clear all the entered data.

Cursor keys

Table 16: Cursor key functions in numeric entry

Key	Function
Up	No function
Down	No function
Right	Use to move the cursor to the next digit position
Left	Use to move the cursor to the previous digit position.

ESC and ENTER keys

Table 17: ESC and ENTER key function in numeric entry

Key	Function
ESC	Use to cancel the operation and return to the previous screen
ENTER	Use to accept the programmed string. The user interface moves to the next programming parameter screen, if any, or returns to the MAIN screen signaling a local programming activity followed by a panel reset.

Note: To program each parameter or option inside the system, the same screen will be used. The screen can adapt itself to the most appropriate program mode for the parameter to program.

If you enter an incorrect value an error message will display for 5 seconds. See [Figure 18](#).

Figure 18: WRONG VALUE screen

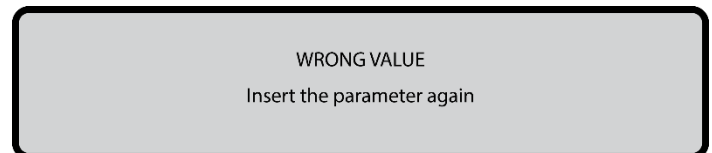

MAIN screen - accessing the system

When you access the panel for the first time after installation, you will be prompted to choose the display language. Once you select the language, the MAIN screen will display. See [Figure 19](#).

Figure 19: MAIN screen

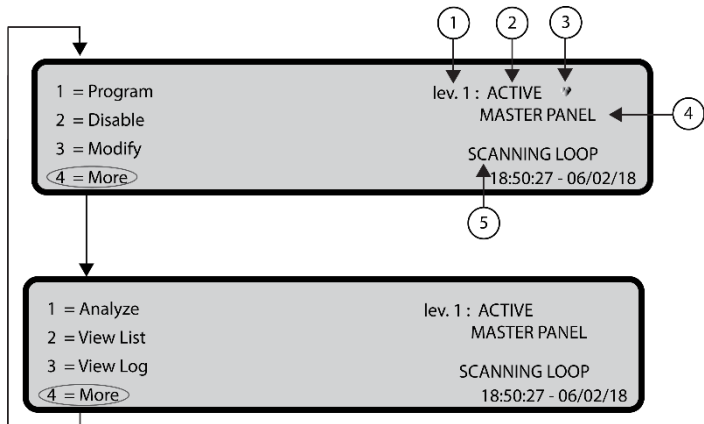

1	Access level
2	Control panel status
3	If blinking, control panel working properly
4	Control panel name
5	Current phase

In this phase the keypad and keys have the following functions:

Alphanumeric keypad

Table 18: Alphanumeric keypad function in MAIN screen

Key	Function
1	Display Program or Analyze
2	Display Disable or View List
3	Display Modify or View Log
4	Select between groups of related functions of keys 1, 2, and 3

Cursor keys

Table 19: Cursor key functions in MAIN screen

Key	Function
Up	Use to increase the brightness of the LCD display
Down	Use to decrease the brightness of the LCD display
Right	Use to increase the contrast of the LCD display
Left	Use to decrease the contrast of the LCD display

ESC and ENTER keys

Table 20: ESC and ENTER key function in MAIN screen

Key	Function
ESC	Use to exit the MAIN screen and to move from the user interface to the front screen or event driven screen, if any. If you press the ESC key for more than 3 seconds, the panel will access level 1.
ENTER	No function

Note: When the panel starts its normal activity and there is no access to the user interface for a period of 30 seconds, the user interface leaves the MAIN screen and reaches the front screen. For more features refer to the description of the MAIN screen in the *FC503 & FC506 Addressable Fire Control Panels User Manual*.

Insert password

Select the **1** key, Program, from the MAIN screen to insert the installer password required to operate at L3. The default installer password is 00000. All digits will be masked with an asterisk.

In this phase the keypad and keys have the following functions:

Alphanumeric keypad

Use the alphanumeric keypad to select the **0** key and access the display.

Cursor keys

No functions are related to the **Up**, **Down**, **Right**, or **Left** keys.

ESC and ENTER keys

Table 21: ESC and ENTER key function in insert password

Key	Function
ESC	Use to return to the previous screen or to clear the entered digits of a password.
ENTER	Use to accept and verify the password.

If the password is incorrect or missing, an error message will appear. See [Figure 20](#).

Figure 20: Wrong password screen



PROGRAM screen

From the MAIN screen, press the **1** key to select the PROGRAM screen. Enter the password. See [Figure 21](#).

Figure 21: PROGRAM screen

FC503 Panel		lev. 3 : PROGRAM ▾	
1 = Auto	2 = Device	3 = SW Zone	4 = Output
5 = Network	6 = Map. Dev.	7 = USB	8 = System
9 = Default	0 = L3 PWD		

In this phase the keypad and keys have the following functions:

Alphanumeric keypad

Table 22: Alphanumeric keypad function in PROGRAM screen

Key	Function
1	Auto: starts the auto-learning of the loop devices and the RS485 network devices (Repeater only).
2	DC Dev: starts the selection and programming screen of the loop devices.
3	SW Zone: starts the programming screen of the software zones.
4	Output: starts the programming screen of the Outputs.
5	Network: starts the programming screen of the RS485 network, FC500MFI modules.
6	Map Device: activates the On Demand device mapping feature.
7	USB: starts the programming screen for the management of the USB memory stick.
8	System: starts the programming screen of the system parameters.
9	Default: forces a default setting restore procedure.
0	L3 PWD: starts the screen to insert the L3 password (Installer code). See 0 Key-insert modify password .

Cursor keys

No functions are related to the **Up**, **Down**, **Right**, or **Left** keys.

ESC and ENTER keys

Table 23: ESC and ENTER key function in PROGRAM screen

Key	Function
ESC	Use to cancel the operation and to return to the MAIN screen.
ENTER	No function

0 Key - insert modify password

On the PROGRAM screen, press the **0** key to modify the Level 3 Installer password. The default password is 00000 and every digit will be masked by an asterisk.

In this phase the keypad and keys have the following functions:

Alphanumeric keypad

Use the alphanumeric keypad to insert a 5 digit password. The first digit must be **0** for INSTALLER 1 (Main Installer) and **9** for INSTALLER 2. The panel verifies the correct entry of the identification digit. In the case of an error, a denial tone is generated.

Cursor keys

No functions are related to the **Up**, **Down**, **Right**, or **Left** keys.

ESC and ENTER keys

Table 24: ESC and ENTER key function in insert modify password screen

Key	Function
ESC	Long press (press for more than 1 s): use to clear all the entered digits Short press (press for less than 32 ms): use to abort the enter password procedure and return to the Calling screen.
ENTER	Use to accept and verify the password.

If the password is incorrect, the Wrong Password screen will display for 5 seconds. See [Figure 20](#).

To avoid entering duplicate passwords, use a specific digit as the first digit of your password. Refer to Table 25 for the first digit of the password for each user or installer.

Table 25: First digit of password

User or Installer	First digit of password
USER 1	1
USER 2	2
USER 3	3
USER 4	4
USER 5	5
USER 6	6
USER 7	7
USER 8	8
INSTALLER 1	0
INSTALLER 2	9

Figure 22: Modify password screen

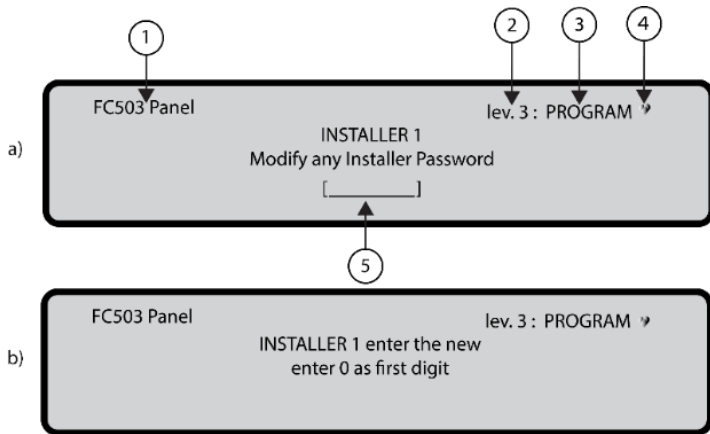

1	Control panel name
2	Access level
3	Control panel status
4	If blinking, control panel working properly
5	Field to insert password

Auto

Use the Auto option from the PROGRAM menu to enroll the loop devices and the RS485 network devices automatically for repeater FC500.

The Auto option consists of three main phases:

1. Auto-enrolling
2. Auto-addressing
3. Devices mapping.

1 Key- Auto-enrolling (auto-learning)

Auto-enrolling (auto-learning) can be done during the installation phase and after changes of the loop and network configurations.

Use the 1 Key to select the Auto option. See [Figure 23](#).

Figure 23: Auto scan results screen

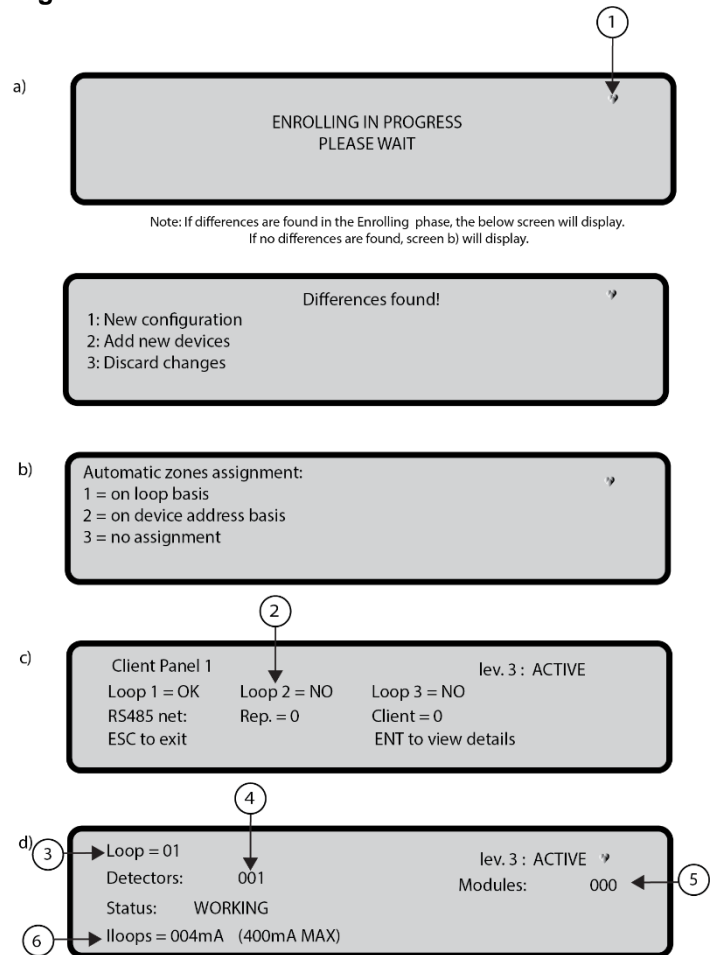

1	If blinking, control panel working properly
2	List of present loop with the autoscan result
3	Num. analysed loop
4	Num. found detectors
5	Num. found modules
6	Value of the current in the three loops, in real time. Data is updated every 5 s.

In this phase the keypad and keys have the following functions:

Alphanumeric keypad

No function is related to the alphanumeric keypad.

Cursor keys

No functions are related to the **Up**, **Down**, **Right**, or **Left** keys.

ESC and ENTER keys

Table 26: ESC and ENTER key function in auto-enrolling

Key	Function
ESC	Use to cancel the operation and return to the MAIN screen
ENTER	No function

If an open circuit is detected when the auto-enrolling is launched, you are prompted to launch the procedure to locate the loop break. The number of devices visible on the left and right side of the loop is calculated and displayed on the LCD.

If a double address fault is detected when the auto-enrolling is launched, you are prompted to switch on the LEDs of the involved devices.

Note: If the faults are generated in unsteady situations, for example with devices which start or stop working randomly or faulty contacts between wires, the result of the new operations may be misleading.

Sounders triggered by

Sounders triggered by allows you to activate the sounders on the control panel alarm or on the zone alarm by default. The enroll procedure on the control panel LCD prompts you to choose whether to activate the enrolled sounders on the control panel alarm or the zone alarm.

Automatic zone assignment

After a few seconds, the panel will prompt you to choose the type of automatic zone assignment. This feature allows you to assign the zone to each enrolled detector and define the first trigger zone for the activation of all outputs channels in the enrolled modules.

The possible schemes used to assign the zones are displayed on the panel during the enroll process:

- 1 = on loop basis
- 2 = on device address basis
- 3 = no assignment

See [Figure 23, d](#).

The three different schemes are:

Scheme 1: All the devices located on each sub loop will be assigned to a separate zone.

For example, all the devices located on Loop 1 (sub loop 1) will be assigned to zone 1 and all the devices located on Loop 2 (sub loop 2) will be assigned to zone 2.

Scheme 2: Each zone contains two device addresses.

For Main Loop 1 of FC503, assign devices from zone 1 to zone 125. For Main Loop 1 of FC506, assign devices from zone 1 to zone 125 and for Main Loop 2 of FC506, assign devices from zone 128 to zone 253.

Examples of zone assignments are:

For Main Loop 1

The first two addresses are assigned to zone 1

The next two addresses are assigned to zone 2

⋮

The last addresses (249 and 250) are assigned to zone 125

For Main Loop 2

The first two addresses are assigned to zone 129

The next two addresses are assigned to zone 130

⋮

The last addresses (249 and 250) are assigned to zone 253

Note: For Main Loop 1 of FC503, devices will not be assigned to zones 126, 127, and 128.

For Main Loop 1 and Main Loop 2 of FC506, devices will not be assigned to zones 126, 127, 128, 254, 255, and 256.

Scheme 3: All the devices found on the loop are assigned to zone 0, system zone.

The previous zone assignment schemes are also applied to the first trigger zone in the case of output only devices such as sounders, beacons, and SNM modules or output channels of input output devices.

For devices already addressed (1-250) the zone assignment procedure is the same as explained above. See [Figure 23, d](#). For devices that are not addressed, if you choose **ESC** at the end of Auto addressing, the panel assigns the zone based on the loop, but if you choose **ENTER** the panel assigns the zone based on its address.

In this phase, only the alphanumeric keypad is active.

Alphanumeric keypad

Use the alphanumeric keypad to select the appropriate zone assignment scheme 1 to 3:

Table 27: Alphanumeric keypad function in the programming screen

Key	Function
1	Scheme 1
2	Scheme 2
3	Scheme 3

Sounders triggered by

In this screen, the installer is prompted to choose whether to activate the enrolled sounders on:

1. Zone Alarm
2. Panel Alarm

Warning enrolling (auto-learning)

When there are differences between the current configuration and the enrolling (auto-learning) results, the Modify any Installer Password screen will appear. See [Figure 22, b](#).

In this phase the keypad and keys have the following functions:

Alphanumeric keypad

Table 28: Alphanumeric keypad function in warning enrolling

Key	Function
1	Use to delete the old configuration and accept the new configuration
2	Use to accept only the differences detected between the new and the previous configuration. The new devices will be added, while the devices that are no longer present will be removed. This applies both to the loop devices and 485 network devices.
3	Use to discard the current configuration that is detected. The previous configuration will still be valid.

Cursor keys

No functions are related to the **Up**, **Down**, **Right**, or **Left** keys.

ESC and ENTER keys

Table 29: ESC and ENTER key function in warning enrolling

Key	Function
ESC	Use to cancel the operation and return to the MAIN screen
ENTER	Use to activate the device details screen

The fields Loop1, Loop2, and Loop3 show if there are any devices connected. In Autoscan OK or NO, you can view details on the Loop. See [Figure 23, c](#). The RS485net: Rep shows the number of repeaters found on the network RS485.

In this phase the keypad and keys have the following functions:

Cursor keys

Table 30: Cursor key functions in loops

Key	Function
Up	Use to show information relating to the next loop
Down	Use to show information relating to the previous loop
Right	No function
Left	No function

ESC and ENTER keys

Table 31: ESC and ENTER key function in loops

Key	Function
ESC	Use to cancel the operation and to return to the MAIN screen
ENTER	Use to accept the device selection and activate the loop device programming

Note: When the enrolling is done, the devices programming data, except their assigned names, will restore to the factory defaults. Any previous configurations will be lost.

Auto-addressing procedure

Auto-addressing creates a sequence of operations to make all the devices accessible by the panel without executing any previous configuration action on the devices during their installation phase. Use the auto-addressing procedure instead of the FC490ST programming tool for loop devices and instead of manually assigning device addresses. The auto-addressing procedure is also used in the device mapping phase to determine or set the geographical position of the devices on the site.

Note: In the program menu of the loop devices, a new item appears. This allows you to switch on and off the device LED to activate the device LED from the control panel user interface in order to easily identify the device on a given field.

The auto addressing procedure is part of the loop devices enroll process in the FC503 and FC506 panels.

To initialize the loop devices enroll process follow these steps:

1. Press the **1** key to enter the PROGRAMMING mode. Enter the default INSTALLER PIN (00000). Each digit will be masked by an asterisk.
2. Select option 1: AUTO.

When all the devices are initialized in the Loop, the panel will prompt you to choose the type of automatic zones assignment:

- 1** = According to the loop
- 2** = According to the addresses of the devices
- 3** = Do not assign. When this choice is made, the user can reach the results phase by:
 - Pressing the **ENTER** key to activate the AUTO-ADDRESSING phase
 - or
 - Pressing the **ESC** key to go to the FAULT screen (not addressable devices).

By default, any addressable device has the address 255. The fire panel examines the serial number of each device and assigns it an address from 1 to 250. If the control panel finds a device with a different address than the default, it leaves the address set on that device.

The control panel is ready to work at this time with the default basic programming.

Optionally, you can set the system addresses differently. To set the system addresses differently, complete the following steps:

1. Press the **ENTER** key, so the fire panel initiates the MAPPING DEVICES phase.
2. In the MAPPING DEVICES phase, activate all the input devices including detectors, input modules, and manual call points in sequence. Return to the front of the fire alarm control panel.
3. Report the sequence of activation on the map of system. The fire panel will store the activation sequence.
4. Use the user interface **Up** and **Down** keys to examine the first activated device. Select the device. When the device is selected, the address will blink. If necessary, change the address. Press **ENTER** to confirm and the address will become fixed.

Note: When Reset is running, the command keys are inoperative. To switch to the programming phase of the device, press the **ENTER** key again.

Second phase of auto-addressing

In the second phase, examine the sounders, the beacons, and the output module.

Locate the devices by scanning the list of auto-addressed devices.

When you reach an output-only device, the device becomes active until a new device is selected or the permanent address is entered. Activation is signaled by a sounder starting to sound, a beacon starting to flash, or an output module illuminating its LED.

Unique indicates that it is the only device of its type on the loop. For example, if only one FC410DDM module is used in the system, it is tagged as Unique and it is not necessary to activate it if you know where it is.

Note: The enroll process does not take place until all of the loop wiring issues have been resolved.

Use the auto-addressing procedure when there are NG1 devices on the loop or it has no effect. The device mapping process does not take place until all of the double address faults have been removed.

Figure 24: Programming option AUTO

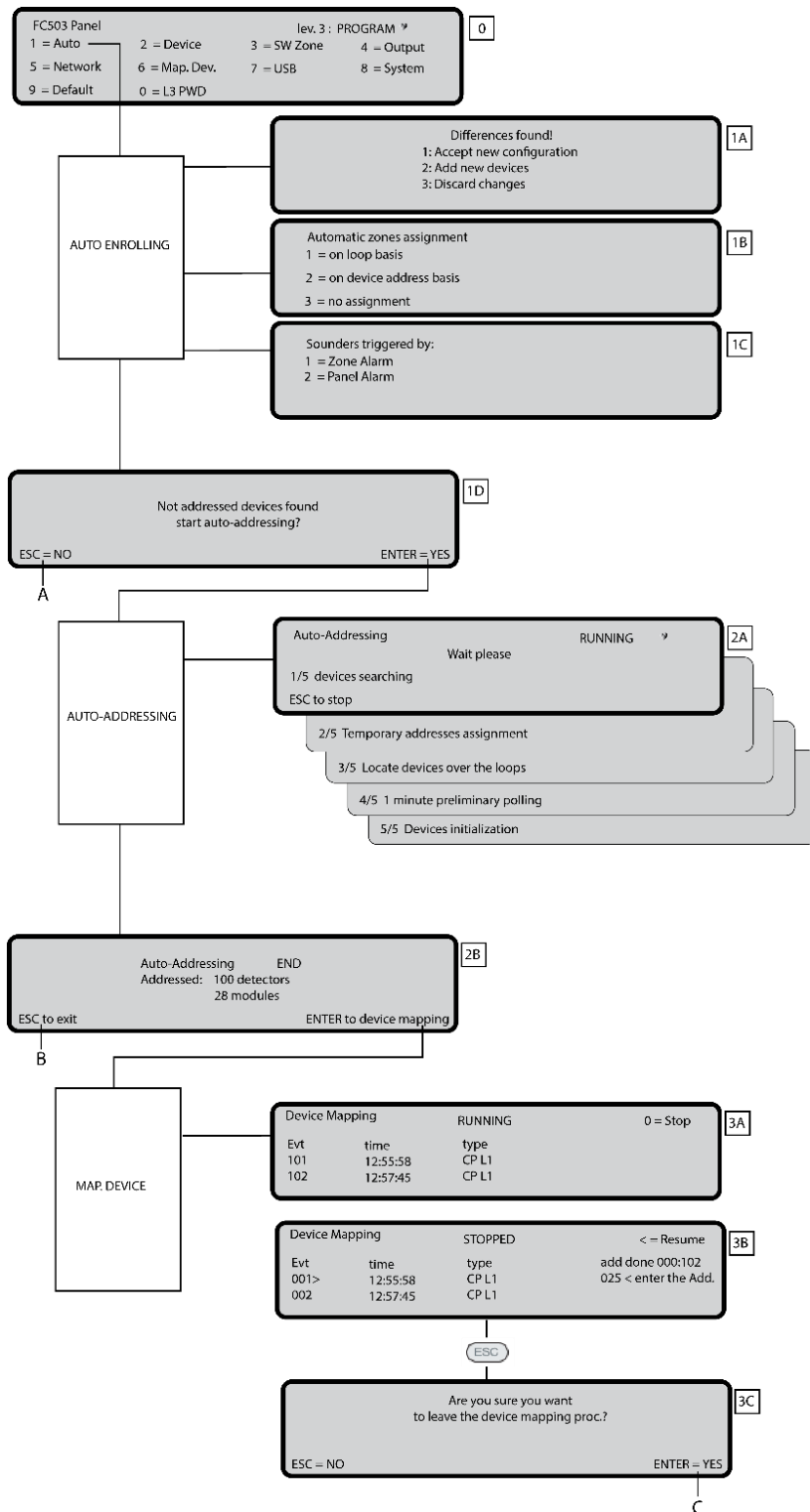

2 Key – Device

The Device option in the PROGRAMMING menu activates the screen used to select and program the devices on the loops. See Figure 24.

Choose the loop

For more information, refer to *View devices* in the *FC503 & FC506 Addressable Fire Control Panels User Manual*.

In this phase the keypad and keys have the following functions:

Alphanumeric keypad

Table 32: Alphanumeric keypad function in choose the loop

Key	Function
1	Loop 1
2	Loop 2
3	Loop 3

Cursor keys

Table 33: Cursor key functions in choose the loop

Key	Function
Up	No function
Down	No function
Right	Use to select the next available loop
Left	Use to select the previous available loop

ESC and ENTER keys

Table 34: ESC and ENTER key function in choose the loop

Key	Function
ESC	Use to delete the procedure and return to the previous screen
ENTER	Use to accept the selection and activate the corresponding programming screen

The selected device field shows the currently selected device. See [Figure 25](#). The add field is used to enter the address of the selected device. The scroll bar of available devices shows the addresses and the class of all devices configured in the selected loop.

The address of the device is represented by three digits and the class of the device is represented by a single character. The class of the device is either *d* for detector or *m* for module.

Example: d087

The scroll can be viewed by using the cursor keys or entering a device address in the add field.

Choose the device

In this phase the keypad and keys have the following functions:

Alphanumeric keypad

Use the alphanumeric keypad to enter the address of the selected device. If the address entered does not exist, the next available device is selected.

Cursor keys

Table 35: Cursor key functions in choose the device

Key	Function
Up	No function
Down	No function
Right	Use to select the next available device
Left	Use to select the previous available device

ESC and ENTER keys

Table 36: ESC and ENTER key function in choose the device

Key	Function
ESC	Use to delete the procedure and return to the previous screen
ENTER	Use to accept the selection and activate the corresponding programming screen

Figure 25: Selecting and programming devices on the loop

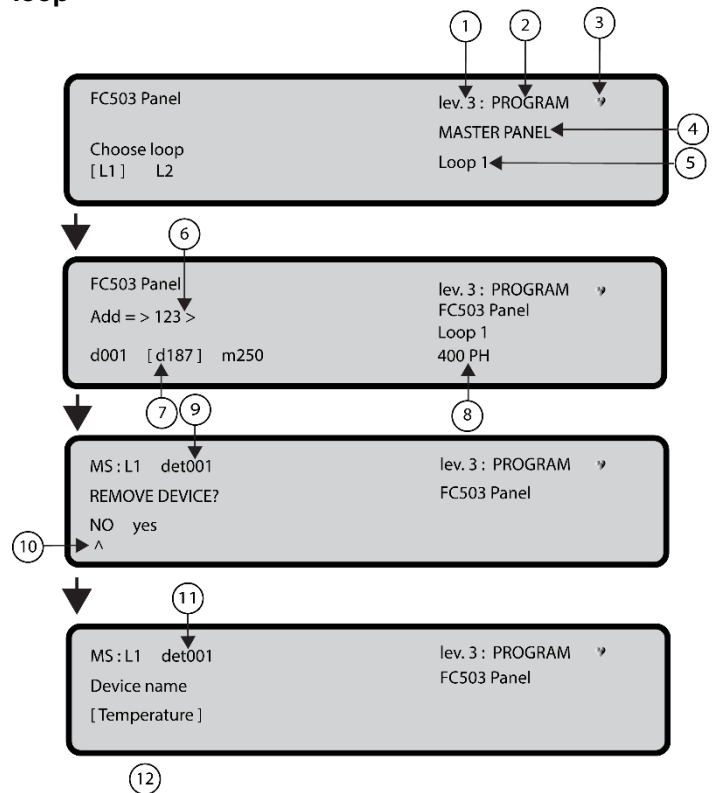

1	Access level
2	Control panel status
3	If blinking, control panel working properly
4	Name of control panel
5	Name of loop

6	Programmed address
7	Selected address
8	Selected device
9	Detector to program
10	Select
11	Detector to program
12	Parameter to program

Table 37: Values table of the programming devices

Heat detector	Smoke detector	Smoke + Heat detector	Heat + CO detector	Heat+Smoke + CO detector
Remove device? No Yes	Remove device? No Yes	Remove device? No Yes	Remove device? No Yes	Remove device? No Yes
Working mode: DAY: A2S CR A1R		Working mode: DAY: Temp=A2S A1R DIS	Working mode: DAY: CO=Default Enhanced Disabled	Working mode: DAY: Universal High Immunity
Working mode: NIGHT: A2S CR A1R		Working mode: NIGHT: Temp=A2S A1R DIS Smoke=Default Enhanced Disable	Working mode: NIGHT: CO=Default Enhanced Disabled	Working mode: NIGHT: Universal High Immunity
		Working mode: DAY: Smoke=Default Enhanced Disable	Working mode: DAY: Temp=A2S A1R DIS	
		Working mode: NIGHT: Smoke=Default Enhanced Disable	Working mode: NIGHT: Temp=A2S A1R DIS	
Detector label	Detector label	Detector label	Detector label	Detector label
Assigned zone	Assigned zone	Assigned zone	Assigned zone	Assigned zone
Detector base	Detector base	Detector base	Detector base	
Standard Isolator Relay Sounder Addressable	Standard Isolator Relay Sounder Addressable	Standard Isolator Relay Sounder Addressable	Standard Isolator Relay Sounder Addressable	
Callpoint label	Generic Module	DDM Module		
Remove device? No Yes	Remove device? No Yes	Remove device? No Yes		
Callpoint label	Module label	Module label		
Assigned zone		Detector type CNV conventional GSO 4-20 mA source GSI 4-20 mA sink		
	Channel to program	Channel to program		
Generic digital input channel (loop devices)	Generic digital output channel (loop devices)	DDM input channel		
Working mode: B NO C NO C NC				
Input label	Output label	Input label		
Assigned Zone	Trigger Zone # 1	Assigned Zone		
	Trigger Zone # 2			
	Trigger Zone event ALA Alarm DLY Delay to alarm WAR warning FAU fault TST Test DK Double Knock			
	Silenceable On Off			
	Trigger Zone # 3 Trigger Zone # 4 Trigger Point # 1 Trigger Point # 2 Trigger Point # 3			

Note: The underlined options are the default options

Loop devices programming screen

After selecting the loop and the device, the option LED is displayed. See [Figure 25](#). The LED option allows for the location of the selected device in the site, lighting its LED

when the option ON is selected.

Note: Press the **ENTER** key to validate the selection. If the device has no LED, the device sounder or beacon will be activated. The option OFF removes the device signalling. The option SKP exits the feature and moves to the normal device programming sequence.

Remote LED

After programming other parameters, it is possible to enable the activation of the programmable Remote LED of a detector.

The detector has an output used to drive the Remote LED. The output is activated only for the detector alarm to which it belongs. It is possible to program it to activate for other events as the activation occurs for other panel outputs and for the detector alarm to which it belongs.

Note: The Remote LED can also be programmed on the FireClass FC500 (FC501_FC503_FC506) Console in the programming screen for the detectors.

Separated programming of the sounder and beacon

Select Separated programming of the sounder and beacon when any of the following devices are selected:

FC410LPAV (all versions)

FC430LPASB

FC430SAB (with **FC430SB**)

FC410LPS-R/W (certified EN54-23)

FC410LPBS (certified EN54-23)

FC430LPBSB (certified EN54-23)

In the programming menu choose the channel, sounder or beacon, to be programmed.

Before the alarm conditions, the user interface will display: **SOUNDER = BEACON YES NO**

If you choose YES, the alarm conditions are selected and applied to both channels. If you choose NO, the channel selection will be displayed and the alarm conditions will be valid for the selected channel.

3 Key - SW zone

The SW zone option in the PROGRAMMING menu activates the screen used to select and program the software zone. See [Figure 24](#), 0.

In this phase the keypad and keys have the following functions:

Alphanumeric keypad

The alphanumeric keypad is used to select the zone number (ID).

Cursor keys

Table 38: Cursor key functions in SW zone

Key	Function
Up	No function
Down	No function
Right	Use to select the next available SW zone
Left	Use to select the previous available SW zone

ESC and ENTER keys

Table 39: ESC and ENTER key function in SW zone

Key	Function
ESC	Use to delete the procedure and return to the previous screen
ENTER	Use to accept the SW zone selection and activate the loop device programming screen

If the SW zone does not exist, the following warning screen is displayed for 5 seconds: "WRONG VALUE! Enter the parameter again". After 5 seconds the user interface returns to the chosen SW zone screens.

Zone name

Enter the zone label (20 characters maximum) using the alphanumeric entry procedures.

SW zone in WALK TEST

After selecting the SW zone, enable or disable the option Zone in WALK TEST (OFF).

- If the option All Devices (ALL) is selected, all the devices assigned to the zone in the WALK TEST mode will not generate an alarm if they are activated but will reach the TEST status.
- If the option detector (DET) is selected, only the detectors assigned to the zone in the WALK TEST mode will not generate an alarm in the case of their activation but will reach the TEST status.
- If the call points (CP) option is selected, only the call-points assigned to zone in WALK TEST mode will not generate alarm in the case of their activation but will reach the TEST status. The presence of a zone in WALK TEST mode is signaled by the TEST yellow LED on the User Interface. More than one zone can be put in WALK TEST mode at the same time.

In this phase the keypad and keys have the following functions:

Alphanumeric keypad

No function is related to the alphanumeric keypad.

Cursor keys

Table 40: Cursor key functions in SW zone in WALK TEST

Key	Function
Up	No function
Down	No function
Right	Use to select the next ON-OFF-ALL-det-CP
Left	Use to select the previous ON-OFF-ALL-det-CP

ESC and ENTER keys

Table 41: ESC and ENTER key function in SW zone

Key	Function
ESC	Use to delete the procedure and return to the programming screen
ENTER	Use to accept the selection and activate the corresponding programming screen

Figure 26: Selecting and programming SW zone

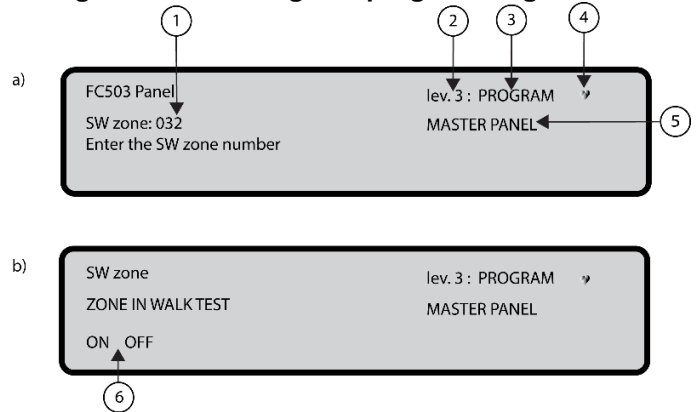

1	Index of SW zone program
2	Access level
3	Control panel status
4	If blinking, control panel working properly
5	Name of control panel
6	Select between ON or OFF

Sounders on (3s)

If YES, every test event (input activation) activates the sounders in the same zone for 3 seconds.

SMOKE DELAY (60s/30min)

For each zone, program the delayed activation of smoke detectors according to the following schedule:
 If the smoke level exceeds the alarm threshold, the panel does not signal anything at first.
 After 60 seconds, if the smoke level is still above the threshold, the system goes into alarm condition.
 Otherwise, there are no signals.

If a new alarm from the same detector or the activation of another sensor in the same zone occurs within 30 minutes, the alarm of fire panel is triggered.

In this phase the keypad and keys have the following functions:

Alphanumeric keypad

No function is related to the alphanumeric keypad.

Cursor keys

Table 42: Cursor key functions in smoke delay

Key	Function
Up	No function
Down	No function
Right	Use to select ON-OFF
Left	Use to select ON-OFF

ESC and ENTER keys

Table 43: ESC and ENTER key function in smoke delay

Key	Function
ESC	Use to delete the operation and return to the previous screen
ENTER	Use to accept the selection and activate the programming screen

DELAY TO ALARM

For each zone, you can program the activation of a common delay to alarm delay of 9 minutes. The procedure and the functionality of the cursors, **ESC**, and **ENTER** keys are the same as the SMOKE DELAY parameters. See [Figure 27, d](#).

Figure 27: Programming option delay detector alarm verification

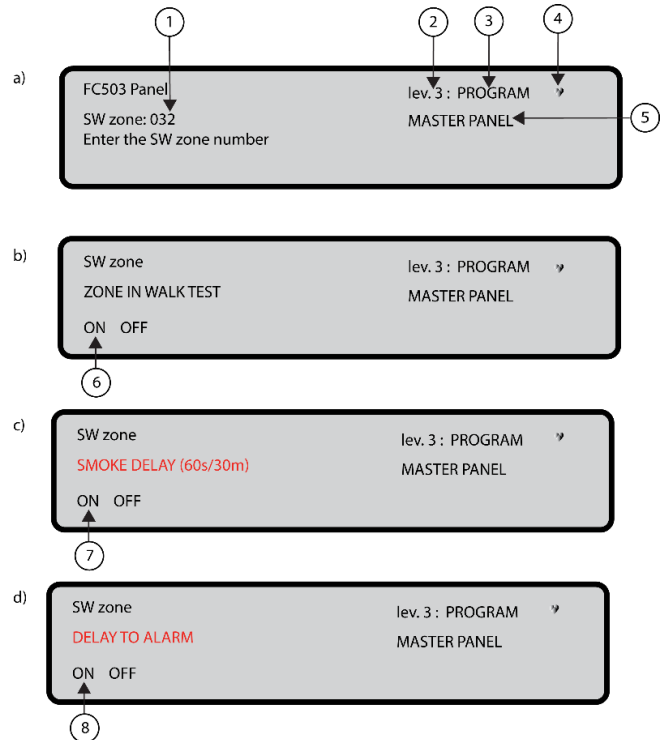

1	SW zone index to program
2	Access level
3	Control panel status
4	If blinking, control panel working properly
5	Name of selected control panel
6	Select the option
7	Select the option
8	Select the option

DLY ALARM TIME (min)

If ON is selected for the option Delay to Alarm you can enter the zone relevant delay to alarm time. The possible value ranges from 0 (no delay) to 9 minutes. The value may be incremented or decremented in steps of 1 minute using the **Up** or **Down** keys.

4 Key – output

The output option, the **4** key in the programming menu, activates the panel on the board output programming screen. Use the output option to select the type of panel on the board output, followed by the programming procedure for that output. See [Figure 24, 0](#).

Choose output

In this phase the keypads and the keys have the following functions:

Alphanumeric keypad

Use the alphanumeric keypad to enter the number of SC output.

Cursor keys

Table 44: Cursor key functions in choose output

Key	Function
Up	Use to show the next output category (SC-OC)
Down	Use to show the previous output category
Right	No function
Left	No function

ESC and ENTER keys

Table 45: ESC and ENTER key function in smoke delay

Key	Function
ESC	Use to cancel the operation and return to the previous screen
ENTER	Use to accept the selection, activate the output selection, and activate the loop device programming screen if the output exists. Otherwise a warning screen is displayed for 5 seconds "WRONG VALUE! Enter the parameter again". After 5 seconds the user interface moves back to the screen for selecting the outputs.

Once the output has been programmed, including type and identification number, and the **ENTER** key is pressed to accept the selection, enter the label for the output.

SET AS SC1

When set as YES, the relevant output will behave as the Sounder Circuit 1 (SC1). This allows redundant output circuits to drive site sounders. The default setting is NO. Setting the option to YES will end the programming sequence for that output.

Note: The panel on board Open Collector outputs (OC1, OC2) may not be programmed to act as SC1.

PANEL ALARM TRIGGER?

When the **PANEL ALARM TRIGGER?** option is set to YES, the relevant output becomes active on the panel alarm condition. Alternatively, a more specific trigger condition may be defined for the output. The default setting is YES.

DISABLEMENT TRIGGER?

The **DISABLEMENT TRIGGER?** option activates the relevant output if any system part is disabled. The default setting is NO.

Note: This parameter is made available only if the parameter PANEL ALARM TRIGGER for the same output is set to NO. Setting the parameter to YES will end the programming sequence for that output. Outputs which have this option programmed will not be silenceable.

This feature is also available for Panel FIRE relay and FC410RIM, FC410SIO, FC410MIO, FC410QMO, FC410QRM, FC410QIO loop modules.

- **OUTPUT NAME**
- **TRIGGER ZONE 1**
- **TRIGGER ZONE 2**
- **TRIGGER EVENT**
- **SILENCEABLE**
- **MONOSTABLE**

Figure 28: Programming SC active on disablements

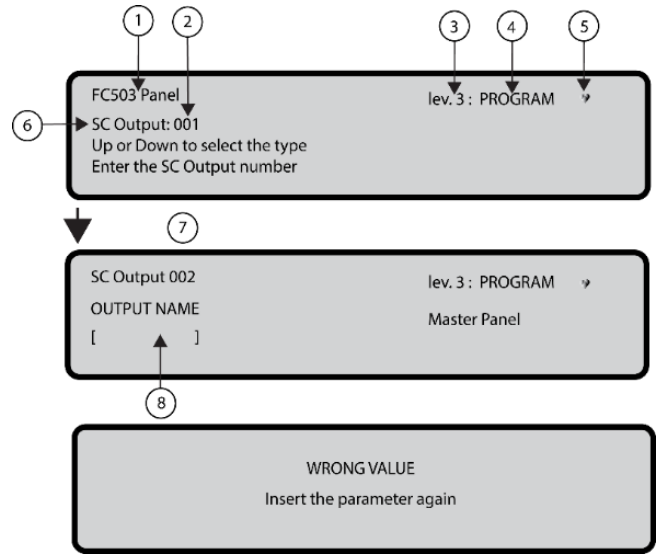

1	Control panel name
2	Output number
3	Access level
4	Control panel status
5	If blinking, control panel working properly
6	Output type
7	Output number
8	Insert output label

Figure 29: Selecting and programming SC active on disablement options

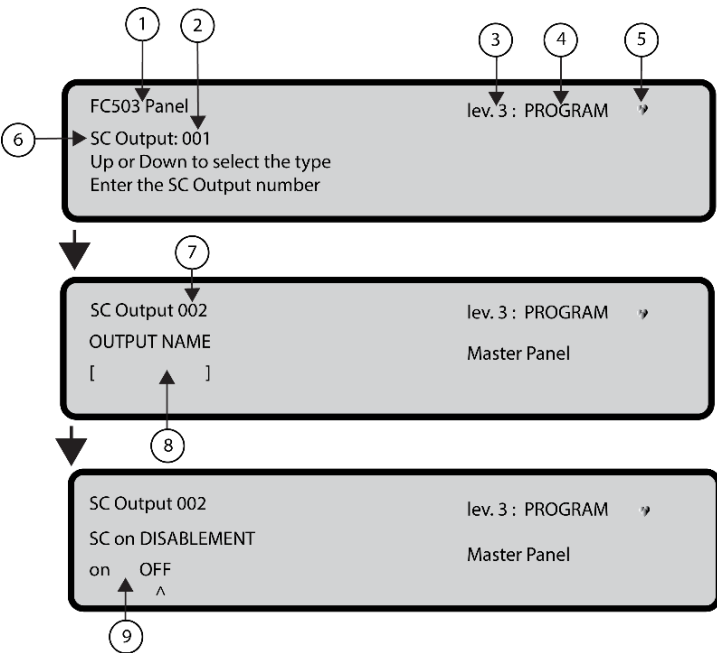

1	Control panel name
2	Output number
3	Access level
4	Control panel status
5	If blinking, control panel working properly
6	Output type
7	Output number
8	Insert output label
9	Select ON or OFF

OUTPUT NAME

Enter or modify the relevant output name using the alphanumeric keypad. The maximum number of characters is twenty.

TRIGGER ZONE 1

Select the first zone for which events, defined later, the output will become active. The entry 0000 means No Zone. Numeric entry modes range from 0 to 128 for FC503 and 0 to 256 for FC506.

TRIGGER ZONE 2

Select the second zone for which events, defined later, the output will become active. The entry 0000 means No Zone. Numeric entry modes range from 0 to 128 for FC503 and 0 to 256 for FC506.

TRIGGER EVENT

Define, for both trigger zones, the event types valid to activate the relevant output. The event type codes are shown in Table 46.

Table 46: Trigger Event Codes

Code	Event Type
ala	Alarm
dly	Delay to Alarm
war	Warning
fau	Fault
tst	Test
dk	Double Knock

You can select more than one trigger event using the multiple selection mode. The selected events are valid for all trigger zones.

When zones trigger condition act in OR mode, it is sufficient that the trigger condition of a single zone is matched to activate the output.

SILENCEABLE

Use SILENCEABLE to select if the output stays active until the **SILENCE/RESOUND SOUNDERS** key is pressed (on option set) or stays active until the **RESET** key is pressed (off option set).

Once a SILENCEABLE output has been silenced, it may be reactivated by pressing the **SILENCE/RESOUND SOUNDERS** key again.

MONOSTABLE

Set MONOSTABLE to ON to automatically deactivate the relevant output when the MONOST. OUTPUT TIME elapses.

The MONOST. OUTPUT TIME is set in the SYSTEM section of the PROGRAM menu and its value is valid for all outputs.

5 Key- network

The network option of the programming menu activates the procedure to configure the FC500MFI modules.

Complete the following steps when all the control panels and the FC500MFI modules are connected in the network:

1. Use the **5** Key to select network from the Programming screen in the user interface. See [Figure 24, 0](#).
2. Use the left and right arrow keys or the **^** symbol under the name of the selected module to select the FC500MFI modules to be configured.
3. Enable a FC500MFI module with the **Up** arrow or disable it with the **Down** arrow. The module name will appear in uppercase if enabled.
4. Press the **ENTER** key to confirm.

In the ANALYZE status (lev.1 level), an acronym is used to display the related status. The acronyms are:

- **OK!** The net. device is sensed as connected and

- working
- **ko!** The net. device is sensed as not connected
- **FAU** The net. device is faulty
- **DIS** The net. device is disabled
- **--** The net. device is not configured in the network
- **OLD** The net. device has an obsolete FW version.

For an explanation of the features and programming addresses, refer to the *FC500MI module* document.

In this phase the keypad and keys have the following functions:

Alphanumeric keypad

No function is related to the alphanumeric keypad.

Cursor keys

Table 47: Cursor key functions in network

Key	Function
Up	Use to enable the selected module
Down	Use to disable the selected module
Right	Use to select the module
Left	Use to select the module

ESC and ENTER keys

Table 48: ESC and ENTER key function in network

Key	Function
ESC	Use to abort the programming procedure
ENTER	Use to confirm the programming procedure and leave the screen

Figure 30: Display to enable the FC500MFI module

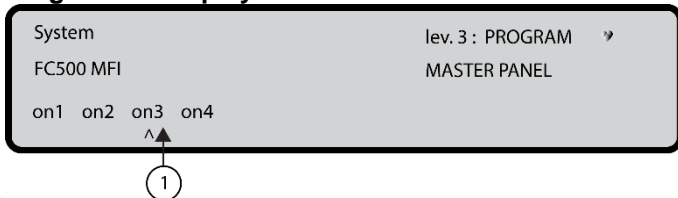

1	Symbol shows the selected module to enable
---	--

6 Key – Map Device

The Map Device option activates the On Demand Map Device feature to modify the devices addressing scheme in a working system. See [Figure 24](#), 0.

Use the On Demand Map Device option in a system where the addressing scheme is well known, because all devices are singularly addressed using the service tool or the device mapping feature embedded in the loop enroll process (1 key).

This feature is not intended to acquire new devices on the loops. Use the Enroll feature to acquire new devices on the loops.

In contrast to the device mapping feature embedded in the loop enroll process, the On Demand version will not

automatically modify devices labels and assigned zone.

Note: All the devices, including the unique type devices will be added to the activated list. The only output type devices are treated as described in the standard device mapping procedure. They will be singularly activated when selected in the list.

In this phase the keypad and keys have the following functions:

Alphanumeric keypad

Use the alphanumeric keypad to enter the new address value from 0-9.

Cursor keys

Table 49: Cursor key functions in map device

Key	Function
Up	Long press: use to start the automatic scroll to the previous event in the list Short press: use to scroll to the previous event in the list.
Down	Long press: use to start the automatic scroll to the next event in the list Short press: use to scroll to the next event in the list.
Right	Use to program the selected device
Left	Use to continue the mapping procedure

Note: To stop the automatic scroll, short press the **Up** or **Down** key.

ESC and ENTER keys

Table 50: ESC and ENTER key function in map device

Key	Function
ESC	Use to end the mapping procedure and exit
ENTER	Use to confirm the entered address value

7 Key – USB

The USB option in the PROGRAMMING menu activates the USB programming screen. Use the 7 key to select the USB programming screen. See [Figure 24](#), 0.

The USB programming screen includes the following options:

- 0) Extra
- 1) Load Audio
- 2) Save Audio
- 3) Load programming
- 4) Save programming
- 5) FW Upgrade
- 6) Save LOG

In this phase the keypad and keys have the following functions:

Alphanumeric keypad

Use the alphanumeric keypad to select the USB activities:

Table 51: Alphanumeric keypad function in USB

Key	Function
0	Load the two languages present in the USB key flash memory while the panel is running. Download the two languages from the CD supplied with the panel or from the FireClass website.
1	Load the audio file containing the voice messages from the USB pen drive to the panel
2	Save the current audio messages from the panel to the USB pen drive.
3	Load the programming data from the USB pen drive to the panel (*).
4	Save the current panel programming data from the panel to the USB pen drive.
5	Upgrade the panel Firmware from the USB pen drive (**) (***).
6	Save the current LOG data in the panel from the panel to the USB pen drive.

Notes:

- (*) The loaded data will overwrite the current data in the panel.
- (**) The file containing the expected FW version to upgrade the panel has to be present in the FW directory in the pen drive.
- (***) To do the firmware upgrade of the FC500 repeater and the MFI module is not possible using the USB pen drive.

Cursor keys

No functions are related to the **Up**, **Down**, **Right**, or **Left** keys.

ESC and ENTER keys

Table 52: ESC and ENTER key function in USB

Key	Function
ESC	Use to exit from the USB activity result screen
ENTER	No function

Note: The default first language is Italian and cannot be overwritten. The default second language is English and can be overwritten at the first panel power-up or at the end of the FW upgrade process of the control panel. The available second language files are contained in a folder on a USB stick connected to the control panel before the first power up. The loaded languages are the languages of the control panel. See [Figure 33](#) and [Figure 34](#). At the end

of the FW upgrade process, the panel will start the procedure Language strings download from USB key at the first panel power-up to load the correct version of the required language. See [Figure 35](#).

Figure 31: Display On Demand Device Mapping

Device Mapping					
Evt	Time	Type	add	done	000/002
001 > 00:	19:50	P	L2: 001 <	enter the address	
002 00:	19:50	PH	L1:		

Figure 32: Example USB activity

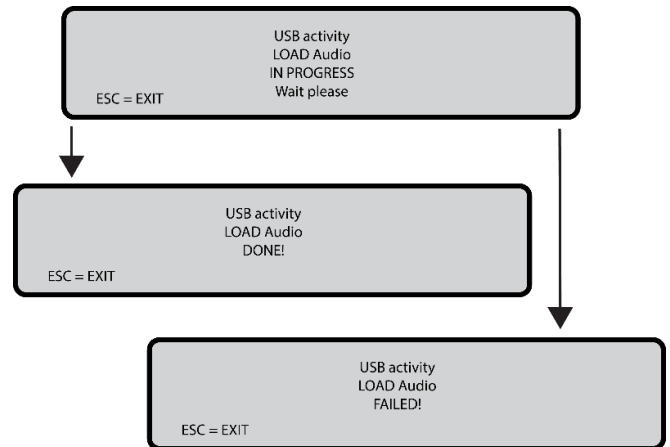
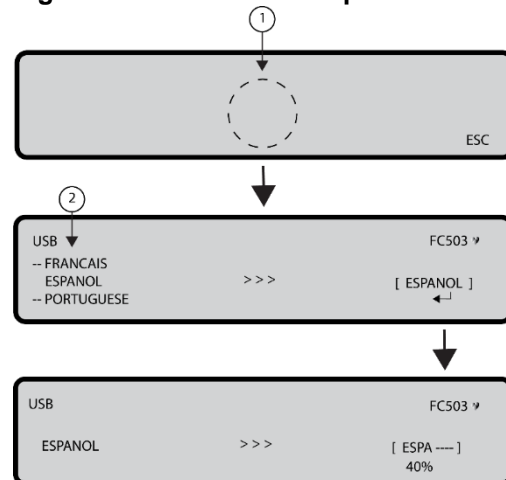

Figure 33: USB activities

FC503 Panel	lev. 3 : PROGRAM ↕	
USB activities	0 = Extras	
1 = Load Audio	2 = Save Audio	3 = Load
4 = Save PROG.	5 = FW Upgrade	6 = Save LOG

Figure 34: LCD screen sequence



1	Language list waiting page
2	List of languages in the USB memory stick

Note: At the end of the process the initial configuration steps will continue. If the language string transfer process from USB to panel fails, a fault page is displayed and the default Italian language is restored.

Figure 35: Select the language of the system

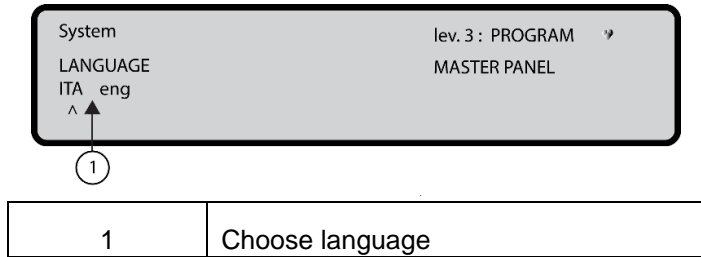

8 Key – System

Use the System option in the **PROGRAM** screen to activate the system language selection screen. See [Figure 24](#), 0.

Note: Other languages can be loaded from the software.

After selecting the language, program the following options:

- PANEL ID
- PANEL TYPE (FC503 or FC506)
- BATTERY TYPE (17Ah or 38Ah)
- DAY/NIGHT MODE or AUTO
- DELAY TO ALARM TIME.
- COPY ON ZONE?
- MONST. OUTPUT TIME
- ENABLE SCREEN SAVER
- 2 Wire Loops

In this phase the keypad and keys have the following functions:

Alphanumeric keypad

No function is related to the alphanumeric keypad.

Cursor keys

Table 53: Cursor key functions in system

Key	Function
Up	No function
Down	No function
Right	Use to select the next option
Left	Use to select the previous option

ESC and ENTER keys

Table 54: ESC and ENTER key function in system

Key	Function
ESC	Use to cancel the operation or return to the MAIN screen
ENTER	Use to accept the selection

Panel ID

Enter up to 4 digits to identify the configuration file system. Ensure you can distinguish it from other configuration files.

- PANEL TYPE (FC503 or FC506)
- BATTERY TYPE (17Ah or 38Ah)

Day / Night / Auto

The display for programming Day, Night, or Auto mode will be shown. If Auto mode is chosen, set the transition time from one mode to another. See the LED Day/Night mode LED change status.

Delay to alarm time

Enter the Delay to alarm time in minutes. The maximum time is 9 minutes. The total time for Delay to alarm time and investigation time should not exceed 10 minutes.

Copy on zone?

Select the YES option using the cursor keys to copy the same Delay to alarm time in all the zones.

MONST. OUTPUT TIME

Enter the period of time that the outputs, with the monostable option set, will stay active once triggered. The value ranges from 1 minute to 30 minutes with a default value of 3 minutes. The mono-stable output time is valid for the entire system.

ENABLE SCREEN SAVER

Select the YES option using the cursor keys to display the customizable front screen. If NO is selected, it is permanently removed.

2 Wire Loops

Each loop may be individually set to work in 2 wires mode (multiple selection). When the 2 wires mode is selected, it is possible to connect devices on both the left and right sides of the loops (2 spurs). This allows for the connection of up to 6 spurs to the panel, mimicking a 6 zones conventional panel.

Notes:

- In all descriptions of the events, the devices are indicated as belonging to a loop. In the case of open loops, it is not possible to distinguish between the left and right side. Loop concept, therefore, will not be meaningful by definition, and localization will be performed using zones as in the case of conventional panels.
- If devices are addressed by the service tool, set them in the 6 zones which correspond to the 6 spurs by assigning the correct zone to each device using the PC console or a control panel LCD.
- If devices are not addressed, a mapping procedure is performed to locate each device and assign the correct zone to it.

Figure 36: Language strings download during panel run time

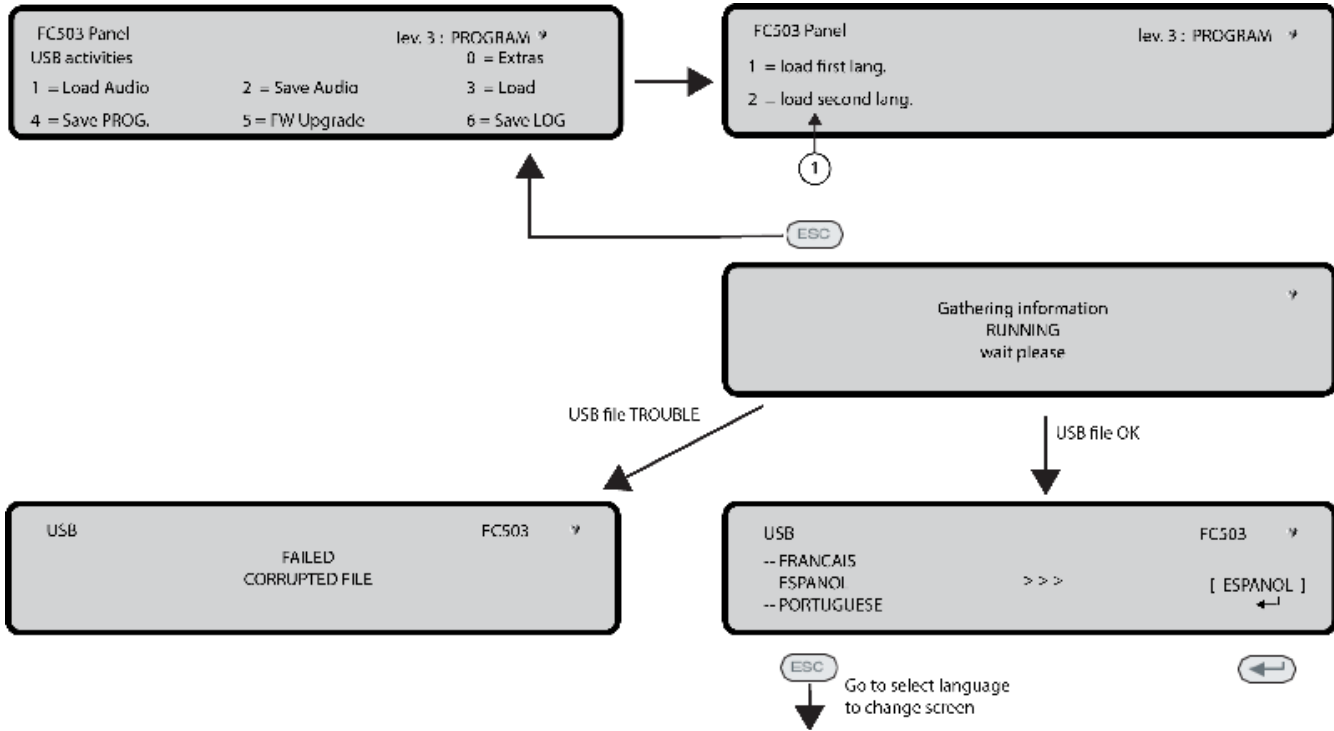

1	Choice of language
---	--------------------

9 Key- Restore default

Use the Restore default option from the PROGRAMMING menu to restore the default setting. Use the **9** Key to select restore default. See [Figure 24,0](#)

Figure 37: Restore Default

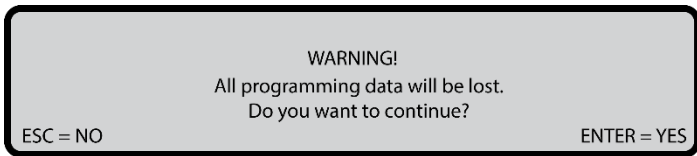

In this phase the keypad and keys have the following functions:

Alphanumeric keypad

No function is related to the alphanumeric keypad.

Cursor keys

No functions are related to the **Up, Down, Right, or Left** keys.

ESC and ENTER keys

Table 55: ESC and ENTER key function in restore default

Key	Function
ESC	Use to cancel the operation or return to the previous screen
ENTER	Use to start the default settings restore procedure

Note: If the motherboard of the panel is connected with a FC500IP module, the procedure to restore factory Default (**9** key) will have no effect. To restore the FC500IP module to factory default refer to the procedure for the FireClass FC500 (FC501_FC503_FC506) Console software.

FC500 repeater address

After the FC503 or FC506 control panels have been connected, the FC500 repeater will verify the presence of the address and its conformity at the first start-up. If the address is correct, the repeater will start to work. If the address is not correct, you will need to enter a new address. The display on [Figure 38](#) will be shown.

In this phase the keypad and keys have the following functions:

Alphanumeric keypad

Use the alphanumeric keypad to insert the 1 digit address.

Cursor keys

No functions are related to the **Up**, **Down**, **Right**, or **Left** keys.

ESC and ENTER keys

Table 56: ESC and ENTER key function in NEW repeater address

Key	Function
ESC	Cancel the operation or return to the previous screen
ENTER	Confirm the address

Modify

Accessing the MODIFY menu

To access the MODIFY menu from the MAIN screen, enter the INSTALLER 1 (default is 00000) or INSTALLER 2 (default is 99999) password. Each entered digit will be masked with an asterisk symbol. The INSTALLER 1 and INSTALLER 2 users can access

Note: If the address of a repeater is changed by mistake, the system will show the message shown in [Figure 38](#). The address of the repeater can be changed using the ESC key.

Figure 38: Serial link is down

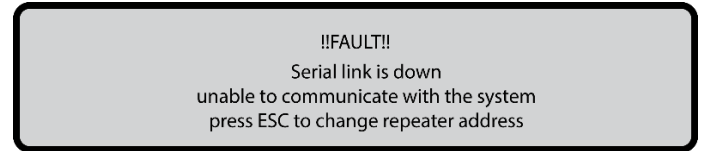

all the options described in the User Manual. Refer to the *FC503 & FC506 Addressable Fire Control Panels User Manual* for User Access details and further information. Both INSTALLER 1 and INSTALLER 2 users can access option **9** Sounders. Only the INSTALLER 1 can access option **7** Password.

Disable

Accessing the DISABLE menu

To access the **DISABLE** menu from the **MAIN** screen, enter the INSTALLER 1 or INSTALLER 2 password. Each entered digit will be masked with an asterisk symbol.

The INSTALLER 1 and INSTALLER 2 users can access all the options described in the user manual. Refer to the *FC503 & FC506 Addressable Fire Control Panels User Manual* for more information.

Both INSTALLER 1 and INSTALLER 2 users can access option **9** Sounders. Only the INSTALLER 1 user can access option **7** Password.

7 Key - password (DISABLE)

The password (DISABLE) option is only enabled if you enter the master INSTALLER PIN in the control panel. The default PIN is 00000.

The **7** Key is used to select the DISABLE password option. Select the option to DISABLE or ENABLE the corresponding password. See [Figure 39](#).

Select the password

In this phase the keypads and the keys have the following functions:

Alphanumeric keypad

Use the alphanumeric keypad to select the identification number of the password.

Cursor keys

Table 57: Cursor key functions in select the password

Key	Function
Up	Show the next type of password
Down	Show the previous type of password
Right	No function
Left	No function

Note: The types of passwords are User password or INSTALLER password.

ESC and ENTER keys

Table 58: ESC and ENTER key function in select the password

Key	Function
ESC	Cancel the operation or return to the previous screen
ENTER	Confirm the selection

Disable the password

In this phase, the display shows the current status of the selected User or Installer password. The possible actions are: ENABLE or DISABLE.

Alphanumeric keypad

No function is related to the alphanumeric keypad.

Cursor keys

No functions are related to the **Up**, **Down**, **Right**, or **Left** keys.

ESC and ENTER keys

Table 59: ESC and ENTER key function in disable the password

Key	Function
ESC	Cancel the operation or return to the previous screen
ENTER	Confirm the selection and move to the MAIN screen followed by a panel reset

9 Key- sounders

The sounders option is visible only if you enter the Control Panel using the INSTALLER 1 (default 00000) or INSTALLER 2 (default 99999) password. Each entered digit will be hidden with an asterisk.

Use the sounders option to enable or disable all the sounders on board or on the loop: SC1, SC2, loop sounder outputs (SAM, SAB, SNM, AV bases Symphoni sounders).

Press **1** to enable all sounders: the event *ALL SOUNDERS ENABLED* is memorized into the log.

Press **2** to disable all sounders: the event *ALL SOUNDERS DISABLED* is memorized into the log.

Figure 39: Display enabled or disabled password

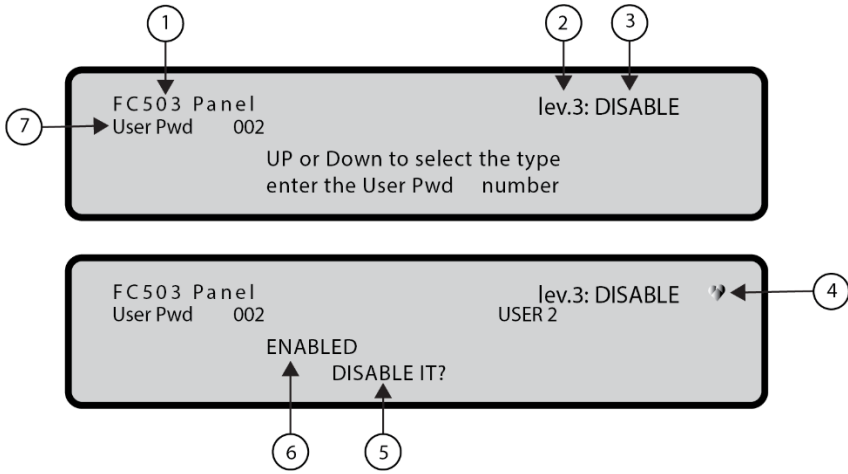

1	Control panel name
2	Access level
3	Control panel status
4	If blinking, control panel working properly
5	Request to enable or disable
6	Current status
7	Password type

Quick start-up procedure

This procedure allows for the quick start-up of the FC503 and FC506 fire detection system.

When the loops are wired, electrically verified, and all the devices have been installed in to the loop, it is possible to connect the loops terminals to the panel.

Note: Before powering on the fire control panel, connect the Earth Line.

By default the setting of switch 45 is set to mains voltage 230 V.

Procedure

1. Turn on the panel and start the FW procedure to verify or program information for the user interface and the panel. This information includes:
 - selected language
 - panel identification number
 - panel type (**FC503** or **FC506**)
 - installed batteries capacity (17 Ah or 38 Ah)
2. When the data has been verified or programmed, enter the date and time. This ensures consistency of the log file.

The panel will start the first system initialization verifying the loops integrity.

Note: The panel in this phase is configured to manage closed loops (4 wires loop). If it is connected to a spur (2 wires loop), it will generate broken loop faults.

At the end of this first initialization phase, the user interface will be displayed on the MAIN screen with the capability to accept to the command and control functions.

3. Select the function Program pressing the key **1**.
4. Insert the Installer password. The default Installer password is 00000. **Note:** Every digit will be masked by an asterisk.
5. Choose an option by pressing key **1**. The enrolling procedure will start.

This procedure is divided into three main phases:

1. Auto-learning
2. Auto-addressing
3. Device Mapping

It is possible to stop the *AUTO* option at the end of each phase; the results are different.

1 Auto-learning

In the auto-learning phase the panel looks for all the devices on the loop already addressed with the service tool.

During this phase, enter what pattern of automatic assignment of zones should be applied to found devices (see [Figure 24,1B](#)) and enter the sounder's triggering scheme (see [Figure 24, 1A](#)).

If the panel is already configured, any differences will be indicated and you will need to indicate how to proceed. See [Figure 24, 1A](#). In this case, the scheme of *Automatic assignment of the zones* will be applied only to any new devices found.

If you stop the AUTO option at the end of the first phase the following results occur:

- The FC503 control panel will take over all devices with an address between 1 and 250.
- The FC506 control panel 1st loop will take over all devices with an address between 1 and 250 and the 2nd loop will take over all devices with an address between 1 and 250.
- The programming device at their default configuration.
- Automatic assignment of labels.
- Automatic assignment of the zones according to the scheme chosen during that phase.
- The output channels of the modules are enabled to activate on fire alarm of the assigned zone. The sounders, sounders and beacons, sounder bases, AV (Audio Visual) bases, and the FC430SNM modules will activate according to the trigger scheme chosen in in this phase. If it was chosen to assign all devices to system (no zone auto assignment), all of the output modules, sounders and beacons will be triggered by the Panel alarm condition.
- The faults NOT PROGRAMMING DEVICE and wrong addresses will be generated in the case of not addressed devices or with address greater than 250, respectively.

See [Figure 24, A](#).

Note: If the enrolling result differs from the previously stored loop configuration a warning message will be displayed and it is possible to reject the present enrolling result, maintaining the previous configuration, or accept them. See [Figure 24, 1A](#).

2 Auto-addressing

The second phase of auto-addressing starts if any devices have been identified as not addressed during the auto-learning phase or have an address greater than 250. During this phase all the not addressed devices will be detected. The panel assigns them a temporary address and configures them at default.

See [Figure 24, 2A](#).

If you stop the AUTO option at the end of the second phase, the following results occur:

- The auto assignment of the address to the not addressed devices
- The control panel will take over all devices
- The programming devices to their default configuration.
- Automatic assignment of labels.
- Automatic assignment of zones based on a loop of belonging.
- The output channels of the modules, sounders and beacons will be set to active on the alarm of the assigned zone. See [Figure 24, B](#).

3 Device mapping

The third and last phase is activated on demand at the end of the auto-addressing phase.

In this phase, the following options are possible:

- Locate the positioning in the system of all the devices through their activation.
- In the case of output modules only, sounders or beacons, the devices will be suitably activated by the panel (see [Figure 24, 3A](#)).
- Carry out a preliminary test of the system.
- Program the most important parameters of each located device.
- Automatically assign labels to all devices.
- Automatically assign the zones based on the assigned addresses of the devices.
- Automatically configure the output channels of the modules, sounders, and beacons to activate on the alarm of the assigned zone.

Table 60: Messages and required actions during the enroll process in function of the loop and panel configuration.

Note: (*) indicates that the message is displayed and relevant action is executed.

LOOP		PANEL	MESSAGE		
			Differences found!	Automatic zones assignment	Not addressed devices found Start auto-addressing
1	All devices not addressed	DEFAULT			*
2	Some devices addressed + Some devices not addressed	DEFAULT		(Applicable only to already addressed devices) *	*
3	All devices addressed	DEFAULT		*	
4	Fully addressed Same configuration	CONFIGURED			
5	Fully addressed Different configuration	CONFIGURED	*	New configuration (Applicable only to all already addressed devices) *	
				Add devices (Applicable only to new already addressed devices) *	
6	Same configuration + Not addressed devices	CONFIGURED			*
7	Different configuration (*) + Not addressed devices	CONFIGURED	*	New configuration (Applicable only to all already addressed devices) *	*
				Add devices (Applicable only to the new already addressed devices) *	*

The third phase represents a powerful and flexible tool that allows you to draw the plant being in front of the panel and without the use of a PC and its SW configuration.

A series of controls have been designed to prevent the generation of incorrect or unmanageable conditions.

Assign each device an address. Ensure that the address meets the following conditions:

- The address does not belong to an older generation device from the FC400 series.
- For **FC503**: The address is in the range of 1 to 250.
- For **FC506**: The address for the 1st loop is in the range of 1 to 250 and the address for the 2nd loop is in the range of 1 to 250.
- The address belongs to a new generation device and the device is present in the list of located devices.
- The address is not a duplicate of an automatically assigned address.

In each case at the end of the device mapping phase a check is performed to detect the presence of doubles addresses. See [Figure 24, C](#). In this case the involved addresses are indicated and it is not possible to end the procedure until the error condition is removed.

Note: You can launch the procedure for the device mapping outside the AUTO function by activating the localization programming function (key **6** on the PROGRAM status). Localization activates the procedure for devices mapping on demand, on a system already configured, and without the need to proceed to their activation. It is meant to correct errors or change the system on the run and use all the features and capabilities described above.

System default

■ Zone assignment

To mimic a conventional panel, the acquired device over the loops will be automatically assigned to a predefined zone.

The two scenarios for zone assignment are:

1. If you exit at the end of the Auto addressing phase without executing the Device Mapping process, the zone assignments are:
Zone 1: all the devices located on Loop 1 (sub loop 1)
Zone 2: all the devices located on Loop 2 (sub loop 2)
Zone 3: all the devices located on Loop 3 (sub loop 3)
2. If you execute the Device Mapping process, the device address to zone assignments at the end of the process are:

For Main Loop 1

The first two addresses are assigned to zone 1
The next two addresses are assigned to zone 2

:

:

The last addresses (249 and 250) are assigned to zone 125

For Main Loop 2

The first two addresses are assigned to zone 129
The next two addresses are assigned to zone 130

:

:

The last addresses (249 and 250) are assigned to zone 253

Note: For Main Loop 1 of FC503, devices will not be assigned to zones 126, 127, and 128.

For Main Loop 1 and Main Loop 2 of FC506, devices will not be assigned to zones 126, 127, 128, 254, 255, and 256.

If an address is not manually assigned to a device, either through the FC490ST or during the device mapping phase, no zone will be assigned to it.

The previous zone assignment schemes are also applied to the first trigger zone in the case of output only devices such as sounders, beacons, and SNM modules or output channel of the input output devices.

Note: In the case of non-zone assigned, the output channel trigger event is the panel alarm.

System default parameters

Temperature Detector Default values

Label	See note (**)
Enablement	Enabled
LED blink	On
Assigned zone	(see: "Zone assignment)
Base type	Normal
Use zone setting	Yes
Day operating mode	A2S
Night operating mode	A2S

Smoke Detector Default values

Label	See note (**)
Enablement	Enabled
LED blink	On
Assigned zone	(see: "Zone assignment)
Base type	Normal
Use zone setting	Yes
Day smoke sensitivity	Medium
Night smoke sensitivity	Medium

Smoke + Temperature Detector Default values

Label	See note (**)
Enablement	Enabled
LED blink	On
Assigned zone	(see: "Zone assignment)
Base type	Normal
Use zone setting	Yes
Day temp. operating mode	A2S
Day smoke operating mode	Normal
Day smoke sensitivity	Medium
Night temp. operating mode	A2S
Night smoke operating mode	Normal
Night smoke sensitivity	Medium

CO + Temperature Detector Default values

Label	See note (**)
Enablement	Enabled
Led blink	On
Assigned zone	(see: "Zone assignment)
Base type	Normal
Use zone setting	Yes
Day temp. operating mode	A2S
Day CO operating	Normal

mode	
Day CO sensitivity	Medium
Night temp. operating mode	A2S
Night CO mode	Normal
Night CO sensitivity	Medium

Modules Default values

Label	See note (**)
Enablement	Enabled
LED blink	On
Activation unit (where applicable)	Off
Act as SC1 (where applicable)	Off

Input Channels Default values

Enablement	Enabled
Channel label	See note (**)
Trigger zone #1	Address related See Zone assignment
Operating mode	Style C, NO
Use zone setting	Yes

Output Channels Default values

Enablement	Enabled
Channel label	See note (**)
Trigger zone #1	Address related See Zone assignment
Trigger zone #2	None
Trigger zone #3 (where applicable)	None
Trigger zone #4 (where applicable)	None
Trigger point #1	None
Trigger point #2	None
Trigger point #3	None
Silenceable	Yes
Active on disablement (where applicable)	Off
Trigger on event	Zone Alarm
Delay from alarm	Off
Silenceable	Yes
Sounder pattern (where applicable)	7Hz fast sweep
Sounder volume (where applicable)	High Beacon
Enablement (where applicable)	Enabled
Beacon flash rate (where applicable)	0.5Hz

DDM module Default values

Label	See note (**)
-------	---------------

Enablement	Enabled
LED blink	On
External power	On
Detector type	4/20 mA Source
Threshold set	Set #1
Input Channels	
Enablement	Enabled
Channel Label	See note (**)
Assigned zone	Address related (see Zone assignment)
Use zone setting	Yes

TSM module	Default values
Label	See note (**)
Enablement	Enabled
LED blink	On
External power	On
Input function	Door monitoring
Loop monitoring	Off
Door monitoring event	Fault
Monitoring time	30s

Input Channels	
Enablement	Enabled
Channel Label	See note (**)
Assigned zone	Address related (see Zone assignment)
Operating mode	Style C

NO Output channel	
Enablement	Enabled
Channel Label	See note (**)
Trigger zone #1	Address related See Zone assignment
Trigger zone #2	None
Trigger point #1	None
Trigger point #2	None
Trigger point #3	None
Silenceable	Yes
Trigger on event	Zone Alarm
Delay from alarm	Off

Zones	Default values
Label	Zone AAA(*)
Enablement	Enabled
Walk test	Off
Detector warning	Off
Delay to alarm	Off
Drift compensation	Off
Double knock	Off
Smoke verification	Off
Delay to alarm duration	0s

On board programmable outputs	Default values
--------------------------------------	-----------------------

Enablement	Enabled
Channel label	Tttt y (****)
Trigger zone #1	None
Trigger zone #2	None
Trigger zone #3	None
Trigger zone #4	None
Trigger point #1	None
Trigger point #2	None
Trigger point #3	None
Silenceable	Yes
Active on disablement (where applicable)	Off
Trigger on event	None
Delay from alarm	Off

General options	Default values
Investigation delay	300s
Main fault delay	1m
Delay to alarm	60s
Silence duration	60s
Reset	2s
Loop 1 wires	4 wires
Loop 2 wires	4 wires
Loop 3 wires	4 wires
Day/Night mode	Day mode
SC1 disablement	Enabled PSTN
Communicator enablement	Not operative
IP Communicator enablement	Not present
NETWORK enablement	Disabled
Delay from alarm #1	0s
Delay from alarm #2	0s
Delay from alarm #3	0s
Delay from alarm #4	0s
Delay from alarm #5	0s

PSTN communicator	Default values
Tone check	On
Start playing after	Selection
Call attempts	3
Iteration	3
Call all tele-monitoring numbers	No
Call all voice message numbers	No
Telephone number label	TEL.NUMBER xx(****)
All Telephone numbers behavior	None
Trigger events	Panel alarm, Panel Fault
Message #1 to #7	Prerecorded

Note:

(**) Automatically assigned Module label.

The label is composed by a brief description of the device followed by its address.

Automatically assigned Module channel label

The label is composed by a first part containing the module acronym and address followed by the brief description of the channel using the acronym printed on the module PCB.

xxx =
module
acronym
yyy=
module
address

For example *DDM098: Ingresso A* is the default label for input 1 of the FC410DDM module at address 98.

(****) tttt represent the on board output type (4 chars), SC outputs -> tttt=SC

Programmable outputs -> tttt=OC y = output number

(****) xx represent the telephone number ID (2 digits).

Accessories

The following is a list of accessories for FC503 and FC506 control panels with a description of the main features. For further information about these accessories, refer to the instructions supplied with the accessories or download them from the FireClass website:

<http://www.fireclass.net>

FC500IP IP module

The FC500IP is an IP module which is used to connect the FC503 or FC506 fire panel to a LAN.

The IP Module may be connected to a LAN using a private IP address or a DHCP address.

The same procedures may be performed using the FireClass FC500 (FC501_FC503_FC506) Console application, either through the serial port or the network. With a public IP address and access to the internet, you can manage and monitor the control panel from anywhere in the world.

4B Universal base

The 4B Universal base is for use with the FC460, FC400, and FC600 series of detectors.

The base may be fixed directly to:

- British (fixing centers 50 mm) or European (fixing centers 70 mm) conduit box
- 4B EM Euro Mounting Box
- The suspended ceiling, through the CTA adapter
- Directly to the ceiling

FC460H or FC400H Addressable heat detector

The FC460H or FC400H detector is intended to plug into the following:

- 4B 4" Universal Base
- 4B-I 4" Isolator Base
- FC430SB Low Power Sounder Base
- FC430LPSB Loop Powered Addressable Sounder Base
- FC430LPASB Loop Powered Addressable Sounder/Beacon Base.

Software within the controller is used to interpret the returned heat values to raise an alarm or other appropriate responses according to the type of detector configured in the FireClass FC500 (FC501_FC503_FC506) Console. The mode of the detector may be:

- EN54-5 A1R, rate-of-rise normal ambient
- EN54-5 A2S, fixed 60°C
- EN54-5 CR, rate-of-rise high ambient

FC460P or FC400P Addressable optical smoke

The FC460P and FC400P optical smoke detectors form part of the FC460 and FC400 series addressable fire detectors.

- 4BI 4" Isolator base
- 4B 4" Universal base
- FC430SB Low power sounder base
- FC430LPSB Loop powered addressable sounder base
- FC430LPASB Loop powered addressable sounder

beacon base.

Software within the controller is used to interpret the returned optical and heat values to raise an alarm or other appropriate response according to the type of detector configured in the FireClass FC500 (FC501_FC503_FC506) Console.

FC460PH or FC400PH Addressable optical smoke & heat detector

The detector is intended to plug into one of the following:

- 4B 4" Universal base
- 4B-I 4" Isolator base
- FC430SB Low power sounder base
- FC430LPSB Loop powered addressable sounder base
- FC430LPASB Loop powered addressable sounder/beacon base

Software within the controller is used to interpret the returned optical and heat values to raise an alarm or other appropriate response according to the type of detector configured in the FireClass FC500 (FC501_FC503_FC506) Console. The mode of detector may be:

- Optical smoke only detector (sensitivity high, normal, or low)
- Optical (sensitivity high, normal, or low) and heat fixed temperature 60°C (A2S)
- Heat only rate-of-rise (A1R) detector (no sensitivity selection)
- Heat fixed temperature 60°C (A2S) (no sensitivity selection)
- Heat rate-of-rise (A1R) detector and optical smoke (sensitivity high, normal, or low)
- HPO (Advanced) smoke detector (sensitivity high, normal, or low)
- HPO Enhanced with heat fixed temperature 60°C (A2S)
- HPO Enhanced rate-of-rise (A1R).

FC460PC Addressable optical smoke & heat detector & CO

The high performance FC460PC detector detects smoke, temperature, and CO. It can accurately determine the presence of all types of fires and has an exceptional immunity to false alarms.

The functionalities of the FC460PC detector are: Self-monitoring, self-testing, status indicator, remote LED, and threshold compensation. FC460PC is compatible with the existing bases.

FC410LI Line isolator module

The FC410LI line isolator module is designed to be used on the FC addressable controller loop circuits. It monitors the line condition and when detecting a short circuit will isolate the affected section while allowing the rest of the addressing circuit to function normally.

The purpose of the FC410LI line isolator module is to ensure that, on a looped addressable system, no short circuit fault can disable more detection devices than would be lost on a conventional non-addressable fire circuit.

FC410MIM Mini input module

The FC410MIM mini input module is designed to monitor fire contacts, such as extinguishing system control, ventilation control, fire door control etc. The module provides one identifiable detection spur which is capable of monitoring multiple normally open contacts or a single normally closed contact. The FC410MIM may be mounted in any electrical enclosure with sufficient depth to accommodate FC410MIM and the contacts monitored by the IN+ and IN- terminals, i.e., no field wiring. The remote LED (if required, not supplied) must be located within the same electrical enclosure.

FC410MIO Small addressable multi I/O module

The FC410MIO multi I/O module has three class B inputs and two outputs from latching relays. The class B inputs can monitor fire contacts such as extinguishing system control, ventilation control, and fire door control. The two relay outputs are dry form C that provide volt-free relay changeover contacts. A maximum of two HVR800 high voltage relay modules can be individually driven and controlled by an FC410MIO if all HVR800s are powered by 24VDC or 24VAC. In this application, the HVR800s are controlled by the two latching relays on the FC410MIO. A maximum of four HVR800 high voltage relay modules can be individually driven and controlled by an FC410MIO if all HVR800s are powered by 120 VAC or 240 VAC. In this application, the HVR800s are controlled by the four control outputs (O1+/O1- to O4+/O4-) on the FC410MIO.

FC410SIO Single input and output module

The FC410SIO single input and output module is designed to provide a monitored open collector input and a volt free relay changeover output.

FC410SIO can switch up to 2 A @ 24 VDC.

FC420CP Addressable break glass callpoint (indoor)

The FC420CP addressable break glass callpoint is designed to monitor and signal the condition of a switch contact that is operated by activating the break glass element. The type of alarm generated by the callpoint is configured in the FireClass FC500 (FC501_FC503_FC506) Console. The FC420CP callpoint meets the requirements of EN54 Pt.11. The FC420CP is fitted to a standard surface mount plastic back box, standard single gang metal plaster box (35 mm for flush mounting) or standard single gang metal plaster box (25 mm) with back box.

FC421CP Addressable break glass callpoint (outdoor)

The FC421CP weatherproof addressable break glass callpoint is designed to monitor and signal the condition of a switch contact that is operated by activating the break glass element. The type of alarm generated by the callpoint is configured in the FireClass FC500 (FC501_FC503_FC506) Console. The FC421CP callpoint meets the requirements of EN54 Pt.11. The FC421CP is fitted into a standard weatherproof break glass callpoint housing.

FC430SAB/SAM Sounder base address modules

The FC430SAM and FC430SAB sounder base address modules are designed to control a loop powered sounder base for use with the FC system. The FC430SAB variant has an integral beacon. They may also be used to drive a relay base. The units are used to supply the address decoding in place of a detector, thus providing a loop powered sounder when used in conjunction with an FC430SB. The modules are colour matched to the sounder bases. The FC430SAM and FC430SAB are locked into the base using the locking device integral to the sounder base.

FC430SB Loop low power sounder base

The FC430SB loop low power sounder base provides an additional sounder function on the FC addressable loop circuit. The FC430SB loop low sounder base requires an associated detector in order to operate, as it uses the address of the detector that is fitted to it. Removal of the detector or loss of power to the loop will cause the sounder to cease operating. A maximum of 30 sounder bases at full volume may be connected to the loop.

4B-I Isolator base

The FC460 and FC400 series detectors, as supplied, use a common 4B-I isolator base assembly. The base may be fixed directly to:

- British (fixing centers 50 mm) or European (fixing centers 70 mm) conduit box
- FC450EMB European mounting box

- Directly to the ceiling

FC490ST Loop service tool

The FC490ST loop service tool is used to program the loop address into FC addressable devices. The FC490ST displays information and performs tests on devices. It has a 32 character backlit LCD alphanumeric display, arranged in 2 rows of 16 characters and four soft keys, F1, F2, F3, and F4. Power for the FC490ST is derived from 4 AA size nickel metal hydride rechargeable batteries. You can also run it from an unregulated +12 VDC input. Examples include a car cigarette lighter connection or a 110 230 VAC mains adaptor which will also recharge the batteries.

FC410CIM Contact input module

The FC410CIM FC addressable contact input module is designed to monitor fire contacts such as extinguishing system control, ventilation control, or fire door control etc. The FC410CIM can be configured as:

- Two spur circuits (Class B) monitoring multiple normally open contacts, with short circuit giving a fault output
- Two spur circuits (Class B) monitoring single normally closed contacts, with short circuit giving a fault output
- Two spur circuits (Class B) monitoring multiple normally open contacts, with short circuit giving an alarm

FC410DIM Detector input module

The addressable FC410DIM provides the ability to connect and Interface one or two zones of 24 VDC 2-wire conventional detectors (non-addressable) to the fire alarm controller.

The FC410DIM monitors the status of detectors and wiring to detectors and signals detector and wiring status back to the controller.

FC410RIM Relay interface module

The FC410RIM relay interface module provides one volt-free relay changeover contact on a latching relay. The relay is controlled by a command sent from the FC fire controller through the addressable loop. The relay state (activated, deactivated, or stuck) is returned to the controller.

FC410BDM Beam detector module

The FC410BDM Beam Detector Interface Module is designed to interface FIRERAY 50 Beam Detectors to the FC Digital Addressable Loop. It cannot be used with other types of beam detectors. The FC410BDM monitors the Fire and Fault contacts and monitors for open and short circuits on the connections between the interface and the beam detector. For remote siting of the FIRERAY 50 an optional BTM800 terminal module can be used with 4 core cable.

The FIRERAY 50 transmitter and receiver units are mounted in the same housing.

The FC410BDM loop powered beam detector interface module is contained on a double sided printed circuit board (PCB) which is fitted into a custom built fascia plate with a protective cover being fitted over the PCB, leaving only the connection terminals exposed. The fascia plate is then fitted onto a standard dual-gang back box with BESA fittings.

FC400CH Addressable carbon monoxide + heat detector

The FC400CH carbon monoxide plus heat detector forms part of the FC400 series addressable fire detectors.

The detector is intended to plug into the following bases:

- 5B 5" universal base
- FC450IB 5" isolator base
- FC430SB low power sounder base
- FC430LPSB loop powered addressable sounder base
- FC430LPASB loop powered addressable sounder beacon base

The detector is designed to transmit, to a remote FireClass controller, digital signals which represent status of the carbon monoxide and heat elements of the detector. Software within the controller is used to interpret the returned carbon monoxide and heat values to raise alarm or other appropriate response according to the type of detector configured in the FireClass FC500 (FC501_FC503_FC506) Console.

801RIL Remote LED Indicator

The 801RIL remote indicator is used where a detector LED is not visible. For example, when the detector is mounted in a roof void or lift shaft. The 801RIL is mounted to a single gang electrical box and is supplied with 2 x M3.5 screws.

801HL Remote LED indicator

The 801HL remote indicator is used where a detector LED is not visible. For example, when the detector is mounted in a roof void or lift shaft.

The 801HL provides a larger indicator for use in place of the 801RIL when longer distances are involved or in VdS influenced markets.

The 801HL can be mounted to any suitable flat surface and has fixing centres at 60 mm and 80 mm.

HVR800 High voltage relay

The HVR800 high voltage relay interface is a non-addressable multi-voltage relay module (operating from 24 VDC, 24 VAC, 120 VAC, and 240 VAC). The encapsulated HVR800 provides a 10 amp volt-free contact that can be used to extend the contact ratings of FC410RIM Addressable Relay Module applications. If all HVR800s are powered by 120 VAC or 240 VAC, a maximum of four HVR800s can be individually driven and controlled by an FC410MIO small addressable multi-input and output module. For AC operation, no external DC power supply unit is required to operate the

relay. When used to switch 24 VDC, the HVR800 must be provided with an external 24 VDC supply which should be switched through the clean relay contacts of an FC410MIO or FC410RIM.

DPK4 and DPK4I

The DPK4 and DPK4I duct probe units have been developed to detect smoke in ventilation ducts. These duct probe units can be used in combination with a wide range of detectors and are suitable for addressable and conventional systems. The duct probes can operate across a wide range of air velocities from 1 m/s to 20 m/s. The duct probe units have a built-in FireClass universal base 5B. There is a range of aluminium probe tubes available for air ducts up to 1500 mm.

FIRERAY 50/100-Optical Beam Smoke Detector

The detector comprises of a transmitter and receiver contained within one enclosure.

The transmitter emits an infrared light beam that is reflected through a prism mounted directly opposite and with a clear line of sight. The reflected infrared light is detected by the receiver and analysed.

The detector has a maximum lateral detection defined by the local national standard. As a guide a common lateral distance of 7.5 m will be used in this guide. Use the latest beam detector standards EN54 part 12, VdS2095 or BS5839 part 1 for further guidance.

The optimal beam distance from the ceiling will be between 500 mm and 600 mm. Use the Local National Standards for guidance.

Range:

Fireray 100 = 50 to 100 m

Fireray 50 = 5 to 50 m

Coverage area:

Fireray 100 = up to 1500 sqm

Fireray 50 = up to 750 sqm

FIRERAY 3000

The FIRERAY 3000 optical beam smoke detector is ideal for applications where the line of sight for the infra-red (IR) detection path is narrow and where the building structure uses reflective surfaces. The unit emits a narrow beam of IR light in order to monitor for smoke and is controlled using a compact low level controller. It allows for the installation of 2 detectors for each system controller. There is a 2-wire interface between controller and receiver. For each detector there are separate fire and fault relays. The FIRERAY 3000 has been designed so that it can be installed by one operator with its laser assisted alignment methods combined with easy to use alignment LED's offering visual feedback. Integrated laser alignment aid can be activated at the controller or at the receiver head.

Range: 5 to 120 m, configurable per set of detectors

FIRERAY 5000

The FireRay 5000 motorised and auto-aligning infrared

optical beam smoke detector can be installed with up to 4 detector heads per system. Once the detector heads are connected, using the Easifit First Fix system, an integral LASER, which is aligned along the optical path of the beam, can be activated. This allows the reflective prism to be sighted quickly. Once the LASER has been used to coarsely align the beam, the auto-optimize beam alignment system takes over and automatically steers the beam into the optimum position. The system controller retains one set of fire and fault relays that is common to all detectors installed.

Range: Each detector is configurable from 8 m to 100 m.

FC410LPSY and FC410LPAV Loop powered sounders and sounder-beacons

The FC410LP series of loop powered addressable sounder and sounder-beacons are designed to be driven from a FireClass control panel through the addressable loop. The FC410LP series of sounders and sounder beacons consist of:

- **FC410LPSYR**: sounder (indoor use) - red housing
- **FC410LPSYW**: sounder (indoor use) - white housing
- **FC410LPSY**: sounder IP65 (outdoor use) - red housing
- **FC410LPAVR**: sounder-beacon (indoor use) - red housing
- **FC410LPAVW**: sounder-beacon (indoor use) - white housing
- **FC410LPAV**: sounder-beacon IP65 (outdoor use) - red housing

The sounder has two volume settings: High (103 dB ±3) or Low (90 dB ±3)

The beacon has two flash rates: Slow Flash (1/2 Hz) or Fast Flash (1 Hz).

The FC410LP devices are synchronised, but not synchronous with other FireClass sounders (FC410SNM) and beacons (FC430SAB).

The first flash of the beacon is synchronised with the start of the tone.

The FC410LP devices have a built in two port isolator.

FC410LPBS-R/W Loop powered sounders and sounder-beacons (EN54-23)

The FC410LPBS series of loop powered addressable Sounder/ Sounder-Beacons are designed to be driven from a FC503 or FC506 control panel through the addressable loop. The FC410LPBS series of sounders and sounder beacons consists of:

- FC410LPBS-R**: sounder (indoor use) - red housing
- FC410LPBS-W**: sounder (indoor use) - white housing
- FC410LPAV**: sounder-beacon IP65 (outdoor use) - red housing

The sounder has two volume settings High (103 dB ±3) or Low (90 dB ±3).

The beacon has two flash rates slow flash (1/2 Hz) or fast flash (1 Hz).

The FC410LPBS devices are synchronised, but not synchronous with other FireClass sounders and beacons of the FC400 series.

The first flash of the beacon is synchronised with the start of the tone. The FC410LPBS devices have a built in two port isolator.

FC430LPBSB and FC430LPASB loop powered addressable sounder beacon base

The FC430LP series of loop powered addressable sounder and sounder- beacons are designed to be driven from an FC503 or FC506 control panel through the addressable loop. Tone, volume, and flash rates are set in the FireClass FC500 (FC501_FC503_FC506) Console. The sounder has four volume settings High (90 dB \pm 3), Mid High (80 \pm 3dB), Mid Low (70 \pm 3 dB) or Low (60 dB \pm 3). The beacon has two flash rates Slow Flash (1/2 Hz) or Fast Flash (1 Hz). The FC430LP Series have a built-in line isolator.

FC430LPBSB Loop powered addressable sounder/beacon base (EN54-23)

The FC430LPBS series of loop powered addressable sounder and sounder- beacons are designed to be driven from an FC503 or FC506 control panel from the addressable loop. Tone, volume, and flash rates are set in the FireClass FC500 (FC501_FC503_FC506) Console.

The sounder has four volume settings High (90dB \pm 3), Mid High (80 \pm 3dB), Mid Low (70 \pm 3dB), or Low (60 dB \pm 3). The beacon has two flash rates Slow Flash (1/2 Hz) or Fast Flash (1 Hz). The FC430LPBS Series have a built-in line isolator.

Table 61: EN54-2

FireClass product code (Current Dev.)	FireClass device name (Current Dev.)	Description	FireClass product code (EN54-23 Dev.)	FireClass device name (EN54-23 Dev.)
516.800.758	FC430LPASB	Loop powered beacon sounder base	516.800.973	FC430LPBSB
516.800.763	FC410LPAVR	Loop powered beacon sounder (indoor use) red	516.800.970	FC410LPBS-R
516.800.764	FC410LPAVW	Loop powered beacon sounder (indoor use) white	516.800.971	FC410LPBS-W
516.800.766	FC410LPAV	Loop powered beacon sounder IP65 (outdoor use)	516.800.972	FC410LPBS

Note: It is possible to substitute old devices with the correspondent new ones (EN54-23) and to keep the same program data. When the old device is physically removed from the loop, the control panel will signal the No answer fault. When the new device with the same address is connected to the loop, the control panel will restore the No answer fault and automatically update its internal database with the new device type.

It is not possible to substitute new EN54-23 devices with old devices that are not EN54-23 approved.

FC410SNM Sounder notification module

The FC410SNM Sounder notification module provides an output, in response to a command signaled from a controller, to activate a number of polarized and suppressed sounders. The sounders are powered from an independent power supply and the module is capable of passing up to a maximum current of 2 A. For example, 24 VDC 50 mA company sounders or a mixture of different current rated sounders not exceeding a maximum current of 2 A.

The possibility of the configuration of extinction, although present in the FC410SNM module, is not available for FC503 and FC506 control panel.

Note: The extinction configuration is not available in the FC503 or FC506 modules.

FC410TSM Door control module

The FC410TSM door control module closes a fire door in case of alarm or fault. The door is normally kept open by electromagnets. The door control module disconnects the electromagnets from power supply in order to allow the door to close. The FC410TSM has a relay changeover output and a monitored input. The FC410TSM contains an integrated line isolator and self-monitoring circuits (monitoring of communication with a panel, loop power monitoring), which enables the fire door to be closed when communication with a panel is lost for longer than 45 s (\pm 5 s) or the loop power drops below $U_{min}=19$ V for more than 15 s (\pm 5 s). In addition, the FC410TSM monitors the external 24 V supply.

FC410DDM Universal fire and gas detector module

The FC410DDM provides the ability to connect and interface 2 zones of 20 VDC 2-wire conventional fire detectors, or two 4-20 mA signaling sensors, to the FireClass fire alarm controller. The FC410DDM monitors the status of the detectors and the wiring to the detectors and signals detector and wiring status back to the controller. The conventional detector circuits can be configured to monitor 1 or 2 Class B spur circuits. The 4-20 mA signaling sensors may be one of two types:

- Current sinking
- Current sourcing

FC410QMO Quad monitored output module

The FC410QMO module comprises of four relays with selectable wiring supervision. The output wiring is monitored for any short or open circuit. Spur and Loop configurations are supported. The module has an integral loop isolator. If it activates, a yellow LED illuminates. The activation remains in place until the short is removed.

FC410QRM Quad relay module

The module provides four voltage free relay changeover outputs. The outputs are monitored with parallel contacts of the relays. Connect the outputs to an auxiliary voltage source to monitor its voltage. Additionally, all the outputs are configurable to the high voltage relay (HVR) mode, which allows you to connect up to four HVR800 modules for switching. For example 240 V loads galvanically isolated.

The module has an integral loop isolator. If the integral loop isolator activates a yellow LED illuminates. A yellow LED illuminates when the integral loop isolator activates. The activation remains in place until the short is removed. Maximum relay current: 2 A
Maximum relay voltage: 30 V

FC410QIO Quad input output module

The module provides 4 monitored digital inputs and 4 potential free relay changeover outputs. The outputs are monitored with parallel contacts of the relays. The outputs can be connected to an auxiliary voltage source and the voltage can be monitored. Additionally, all the outputs can be connected to the HVR800, for switching high power galvanic isolated loads. For more details refer to the HVR800 documentation. The module has an integral loop isolator. If this activates, a yellow LED illuminates. The activation remains in place until the short is removed. The digital input monitoring and isolator functions are both configurable.

Maximum relay current: 2 A
Maximum relay voltage: 30 V

FC440SB Addressable Base Sounder

The visual indicating device (VID) sounder-beacons and sounders are loop powered units driven from an addressable controller panel. Set the tone and volume in the FireClass FC500 (FC501_FC503_FC506) Console.

Selectable flash rates are:

- a) 1 Hz (flash every second)
- b) 0.5 Hz (flash every 2 seconds)

The visual indicating device sounder-beacons are available in ceiling and wall mounted variants, including an outdoor wall version. The FC440SB variants are:

- FC440SW
- FC440SR
- FC445SR
- FC440AIW
- FC440AIR
- FC445AIR
- FC440AIB

FC440AVB Addressable Sounder Base VAD Sounder

The visual alarm device (VAD) sounder-beacons are loop powered units driven from an addressable controller panel. All VADs have a built-in two port loop short circuit isolator.

Configure the settings for tones, volume, beacon flash, and status monitoring using the control panel.

The VADs are available in ceiling and wall mounted variants, including an outdoor wall version. The

FC440AVB variants are:

- FC440AVW
- FC440AVR
- FC445AVR
- FC445CAV
- FC440AVB
- FC441AVB
- FC440CAVB

Panel and repeater firmware upgrade quick guide

Firmware upgrade procedure using FireClass FC500 (FC501_FC503_FC506) Console software

1. Connect the communication cable of choice (either PC - LINK or USB).
2. If you are using a USB cable, insert the USB cable into the PC host port and install the USB driver when asked.
3. Find the correct drivers in the FireClass FC500 (FC501_FC503_FC506) Console Software installation directory: C:\Program Files\FireClass\FireClass_FC500_Console\Drv.

Notes:

- For 32 bit Windows™, use the X86 version.
 - For 64 bit Windows™, use the X64 version.
 - Windows may show a driver security warning. In this case, continue with the installation procedure.
4. Proceed to the FireClass FC500 (FC501_FC503_FC506) Console software main screen, select the **Communication** tab and the channel you will use: RS232 (COMx) or USB (USBx).

Figure 40: Selecting a channel

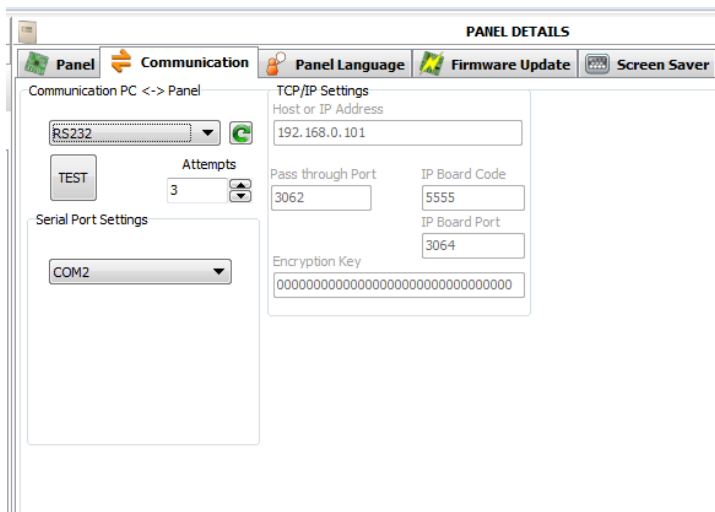

5. Proceed to the FireClass FC500 (FC501_FC503_FC506) Console software main screen and select the **Firmware Update** tab.
6. Select **Browse** and load the .BIN packet containing the FW (firmware).
7. The software scans the packet and then shows the FW versions read on file and those detected on the connected panel.

Figure 41: Scanning for firmware versions

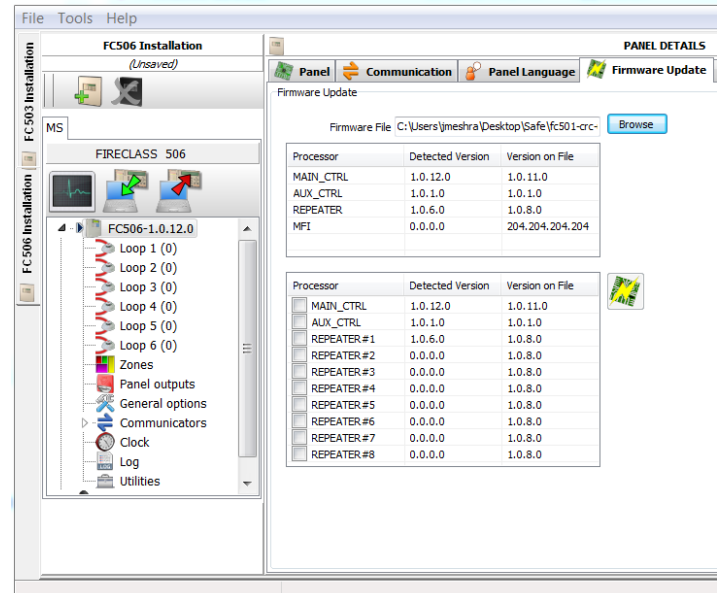

8. Select the FW for updating and click the **Start flash** button, as seen in Figure 41.
9. Wait until all the firmware files have been updated (you will receive a confirmation notice from the software).

Notes:

- You may receive a fault warning during the aux controller or the PTSN communicator updates.
 - When all FW update related faults are automatically restored, the system is considered fully operative again.
10. Verify that the FW version running is the updated version on the **Panel** tab.

Firmware upgrade procedure using the USB pen drive

1. Access the updated firmware packet from the FireClass website; the correct file name has the 'FWxxxxxxBIN' format.
2. Get a FAT or FAT32 USB pen drive.
3. Create a folder named 'F_FW' at the root of the USB pen drive.
4. Copy the downloaded file into the 'F_FW' folder.
5. Insert the USB pen drive on a working panel.
6. Click on the **1=Program** menu and select option **7=USB** followed by option **5=FW Upgrade**.
7. Wait until the panel returns to the main page. This procedure takes a few minutes to complete.

Note: The upgrade procedure may take several minutes to complete

Specifications

These specifications are aimed at suitably qualified technicians experienced in the installation and commissioning of fire detection and alarm systems, who have also received FIRECLASS training.

Technical features

Table 62: FC503 and FC506 technical features

Control panel	FC503	FC506
Main voltage	230 V ~	230 V ~
	60/50 Hz -15/+10%	
Aux. outputs nominal voltage	27.6V	
Aux. outputs min. and max. voltage	19.0 ÷ 27.6V	
Minimum output voltage	19.0 VDC ± 5 %	
Maximum current drawn	1.6 A (230V)	
Ripple	1 %	
Maximum internal resistance of the battery and associated circuitry	1 ohm	
Temperature range	-5°C to +40°C	
Storage temperature	-20°C to +70°C	
Operating humidity	Up to 95% non-condensing	
Dimensions (W x H x D)	429.62 mm x 493.17 mm x 126.97 mm	
Weight (Without batteries)	8 kg	

Table 63: FC500 technical features

Repeater	FC500
Operating voltage	27.6 VDC
Maximum current	130 mA
Temperature range	-5 to +40°
Storage temperature	-20°C to +70°C
Operating humidity	Up to 95% non-condensing
Dimensions (W x H x D)	345.44 mm x 234.61 mm x 55.72 mm
Weight	2.7 kg

Description of the terminals

[Table 64](#) describes the terminals of the main board and switching power.

The first status is the standby (normal) status, followed by the alarm status. The voltage present during the different operating conditions is indicated for each terminal, as well as the maximum current in amps that can circulate.

Table 64: Terminals description

TERM.	Description	v(V)	i(A)
Main boards			
+L1- LEFT	(+)Loop 1-Positive signal, left side. (-)Loop 1-Negative signal (return), left side	—	—
+L1- RIGHT	(+)Loop 1-Positive signal, right side. (-)Loop 1-Negative signal (return), right side	—	—
+L2- LEFT	(+)Loop 2-Positive signal, left side. (-)Loop 2-Negative signal (return), left side.	—	—
+L2- RIGHT	(+)Loop 2-Positive signal, right side. (-)Loop 2-Negative signal (return), right side.	—	—
+L3- LEFT	(+)Loop 3-Positive signal, left side. (-)Loop 3-Negative signal (return), left side.	—	—
+L3- RIGHT	(+)Loop 3-Positive signal, right side. (-)Loop 3-Negative signal (return), right side.	—	—
+L4- LEFT	(+)Loop 4-Positive signal, left side. (-)Loop 4-Negative signal (return), left side	—	—
+L4- RIGHT	(+)Loop 4-Positive signal, right side. (-)Loop 4-Negative signal (return), right side	—	—
+L5- LEFT	(+)Loop 5-Positive signal, left side. (-)Loop 5-Negative signal (return), left side	—	—
+L5- RIGHT	(+)Loop 5-Positive signal, right side. (-)Loop 5-Negative signal (return), right side	—	—
+L6- LEFT	(+)Loop 6-Positive signal, left side. (-)Loop 6-Negative signal (return), left side	—	—
+L6- RIGHT	(+)Loop 6-Positive signal, right side. (-)Loop 6-Negative signal (return), right side	—	—
SH	Terminal for connection of the shield of cables	—	—
+RS485-	SERIAL BUS. Terminals to connect the FC500 and FC500MFI modules	—	—
[M] [24R]	24 V RESET ABLE AUXILIARY POWER SUPPLY: Negative present on terminal [M]; Positive present on terminal [24R].	27.6	0.5(1)
[M] [24A]	24 V AUXILIARY POWER SUPPLY: Negative present on terminal [M]; Positive present on terminal [24A].	27.6	0.5(1)
[LE] [LI] [—]	Terminal for connection of the external telephone line Terminal for connection of the internal telephone line Terminal for connection of the Earth cable	—	—
[NC] [NO] [C] FIRE	FIRE ALARM OUTPUT - Non-Supervised: standby → [C] connected to [NC] with [NO] open; in the event of ALARM → [C] connected to [NO] with [NC] open	—	—
[NC] [NO] [C] FAULT	FAULT ALARM OUTPUT - Non-Supervised: standby → [C] connected to [NC] with [NO] open in the event of fault → [C] connected to [NO] with [NC] open	—	—
+BAT-	BATTERY CONTROL PANEL POWER SUPPLY	27.6	—
[OC1] [OC2]	Programmable Outputs(Open collector)- Silenceable-Bypassable (Disabled)-Supervised (The polarity is not programmable)	27.6	—
[SC1] [SC2]	(Programmable, SC2 only),Supervised, Silenceable, Bypassable (Disabled) ALARM Outputs: Panel in Standby → negative on [+] terminal; positive 27.6 V on [-] terminal Panel in Alarm → positive 27.6 V on [+] terminal; negative 0 V on [-] terminal	—	(2)

Table 65: Current distribution of FC506 control panel

FC506 control panel	
Switching power supply BAQ140T24 (I _{max} = 5.5 A)	
12 Ah Battery	Battery_Charge_80%_24H = $(12 \cdot 0.8) / 24 = 400$ mA
	For_panel = 5500 - 400 = 5100 mA
	Panel load distribution
	Main_Board_Electronics = 250 mA
	Total_Loops_1_2_3 (*) = 800 mA @40V (1300 mA @27V)
	Total_Loops_4_5_6 (**) = 800 mA @40V (1300 mA @27V)
	Total_Outputs (***) = 2000 mA
	FC500IP = 100 mA (****)
	Residual = 150 mA
17 Ah Battery	Battery_Charge_80%_24H = $(17 \cdot 0.8) / 24 = 566.66$ mA -> 600 mA
	For_panel = 5500 - 600 = 4900 mA
	Panel load distribution
	Main_Board_Electronics = 250 mA
	Total_Loops_1_2_3 (*) = 800 mA @40V (1300 mA @27V)
	Total_Loops_4_5_6 (**) = 800 mA @40V (1300 mA @27V)
	Total_Outputs (***) = 1900 mA
	FC500IP = 100 mA (****)
	Residual = 50 mA
38 Ah Battery	Battery_Charge_80%_24H = $(38 \cdot 0.8) / 24 = 1266.66$ mA -> 1500 mA
	For_panel = 5500 - 1500 = 4000 mA
	Panel load distribution
	Main_Board_Electronics = 250 mA
	Total_Loops_1_2_3 (*) = 800 mA @40V (1300 mA @27V)
	Total_Loops_4_5_6 (**) = 800 mA @40V (1300 mA @27V)
	Total_Outputs (***) = 1000 mA
	FC500IP = 100 mA (****)
	Residual = 50 mA

Notes:

(*): I_{Total_Loops_1_2_3} is the sum of currents absorbed on Loops 1, 2, 3

(**): I_{Total_Loops_4_5_6} is the sum of currents absorbed on Loops 4, 5, 6

(***): I_{Total_Outputs} is the sum of the currents drawn by the terminals SC1, SC2, 24A, 24R, 24V-RS485.

(****): If the FC500IP module is not be used then the relative amount of current (100 mA) can be drawn from the SC1, SC2, 24A, 24R, 24V-RS485 terminals.

Table 66: Current distribution of FC503 control panel

FC503 control panel	
Switching Power Supply BAQ140T24 (I _{max} = 5.5 A)	
12 Ah Battery	I _{Battery_Charge_80%_24H} = (12*0.8)/24 = 400 mA
	I _{For_panel} = 5500 - 400 = 5100 mA
	Panel Load Distribution
	I _{Main_Board_Electronics} = 250 mA
	I _{Total_Loops_1_2_3 (*)} = 800 mA @40V (1300 mA @27V)
	I _{Total_Outputs (***)} = 3300 mA
	I _{FC500IP} = 100 mA (****)
	I _{Residual} = 150 mA
	I _{Battery_Charge_80%_24H} = (12*0.8)/24 = 400 mA
17 Ah Battery	I _{Battery_Charge_80%_24H} = (17*0.8)/24 = 566.66 mA -> 600 mA
	I _{For_panel} = 5500 - 600 = 4900 mA
	Panel Load Distribution
	I _{Main_Board_Electronics} = 250 mA
	I _{Total_Loops_1_2_3 (*)} = 800 mA @40V (1300 mA @27V)
	I _{Total_Outputs (***)} = 3100 mA
	I _{FC500IP} = 100 mA (****)
	I _{Residual} = 150 mA
	38 Ah Battery
I _{For_panel} = 5500 - 1500 = 4000 mA	
Panel Load Distribution	
I _{Main_Board_Electronics} = 250 mA	
I _{Total_Loops_1_2_3 (*)} = 800 mA @40V (1300 mA @27V)	
I _{Total_Outputs (***)} = 2200 mA	
I _{FC500IP} = 100 mA (****)	
I _{Residual} = 150 mA	

Notes:

(*): I_{Total_Loops_1_2_3} is the sum of currents absorbed on Loops 1, 2, 3

(**): I_{Total_Loops_4_5_6} is the sum of currents absorbed on Loops 4, 5, 6

(***): I_{Total_Outputs} is the sum of the currents drawn by the terminals SC1, SC2, 24A, 24R, 24V-RS485.

(****): If the FC500IP module is not be used then the relative amount of current (100 mA) can be drawn from the SC1, SC2, 24A, 24R, 24V-RS485 terminals.

Table 67: Max withdrawable current for FC503 and FC506 control panels

Terminals	Max Current
SC1	0.5 A
SC2	0.5 A
24A	1 A
24R	1 A
24V-RS485	1 A

CPR information

 0051
Tyco Fire & Security GmbH, Victor von Bruns-Strasse 21, 8212 Neuhausen am Rheinfall, Schaffhausen, Switzerland 19 DoP-2018-4260 (FC503/ FC506 with optional FC500IP module)
EN 54-2: 1997+A1:2006 EN54-4: 1997+A1:2002+A2:2006 EN 54-21: 2006 Control and indicating equipment with integrated power supply equipment for fire detection and fire alarm systems for buildings with alarm transmission and fault warning routing equipment. EXPECTED OPTIONS Fault signals from points Dependencies on more than one alarm signal: type A and B Delays to outputs Disabling of addressable point Test condition Output to fire alarm device



120.515.873_FC-FC500-P-I-01, Doc. version 2.0, 23. October 2019

© 2019 Johnson Controls. All rights reserved. All specifications and other information shown were current as of document revision date and are subject to change without notice.

www.fireclass.net

Tyco Fire & Security GmbH, Victor von Bruns-Strasse 21, 8212 Neuhausen am Rheinfall, Switzerland