

Romana

Panou de apel video pe 2 fire

Manual de utilizare

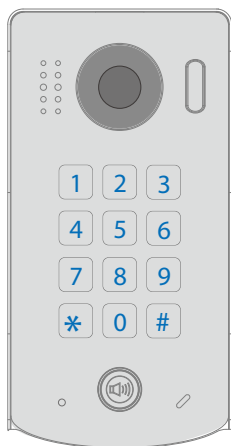

DT611-MK

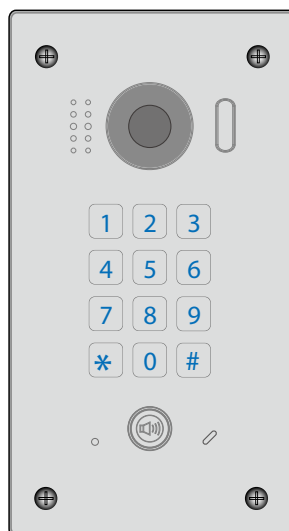

DT611F-MK

Cuprins

1. Parti si functii	1
2. Descriere terminale.....	2
3. Montare panou de apel.....	2
4. Cablare si conexiune incuietoare	3
5. Pan-tilt & Zoom	8
6. Configurare	9
7. Operatiuni deschidere usa.....	16
8. Specificatii	16
9. Lungime cablare	17
10. Attentionari	18

1. Parti si functii

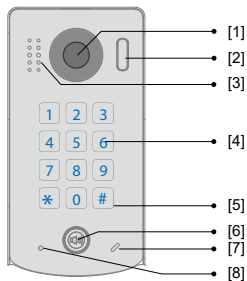

DT611-MK

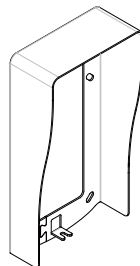
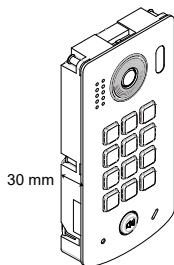

Aparatoare de ploaie

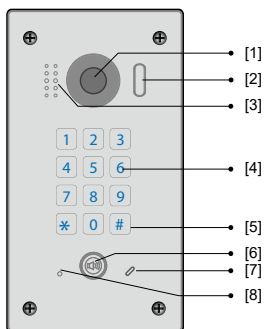

DT611F-MK

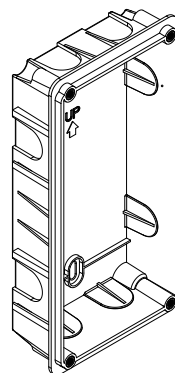
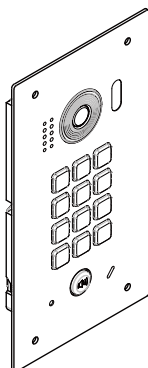

Cutie de montare

- [1] Lentila camera
- [2] LED camera
- [3] Difuzor

- [4] Taste
- [5] LED taste
- [6] Buton de apel

- [7] Microfon
- [8] LED alimentare

2. Descriere terminale

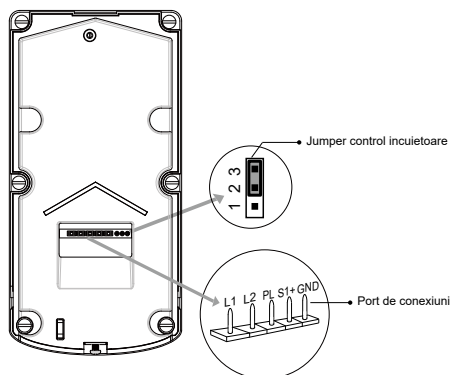

- **Jumper control incuetoare:** Selectare tip yala (Fail-safe sau Fail-secure)
- **Port principal:** Conectare magistrala de date si incuetoare
- **L1,L2:** Conectare magistrala nepolarizata
- **PL:** Intrare sursa de alimentare "+" pentru incuetoare externa
- **S1+,GND:** Conectare incuetoare

3. Montare panou de apel

DT611-MK

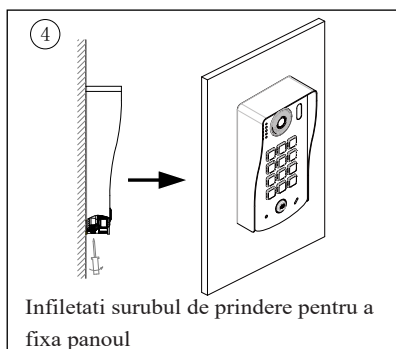
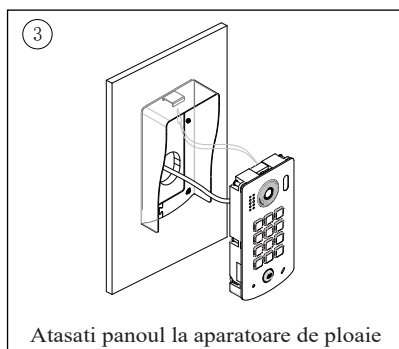
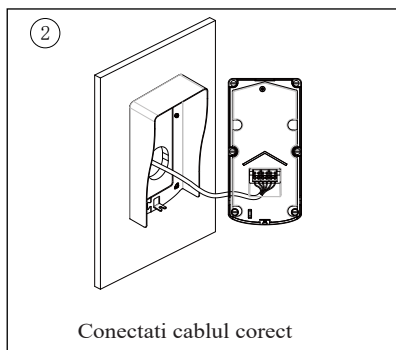
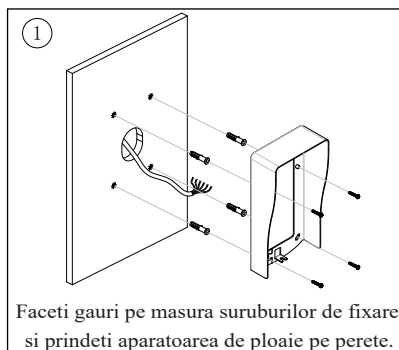

DT611F-MK

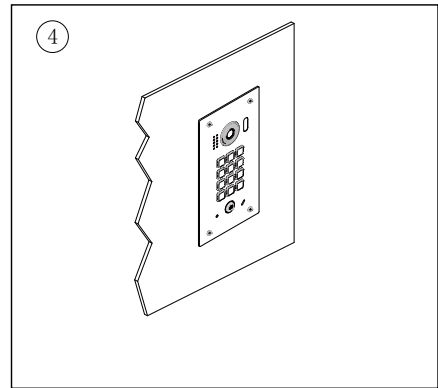
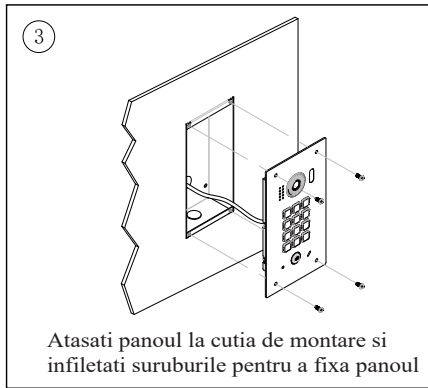
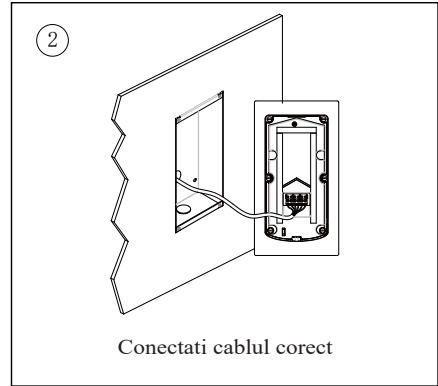
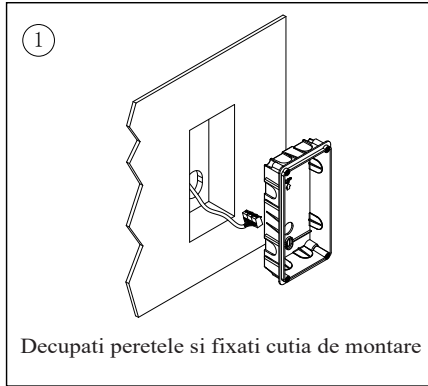

4. Cablare si conexiuni incuietoare

Conexiune de baza

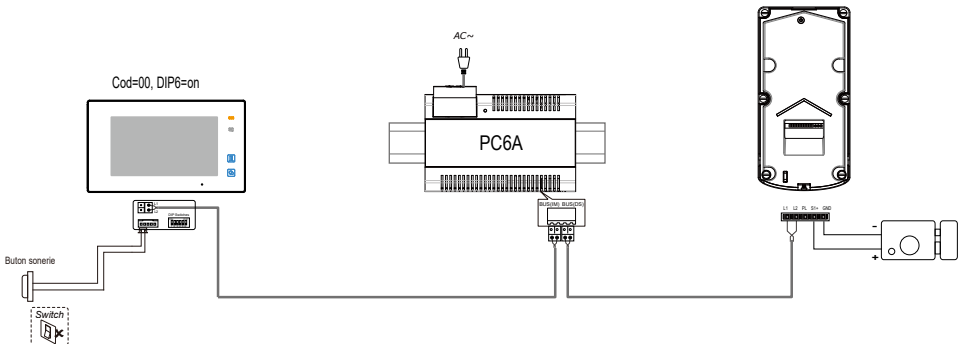

Conexiune incuietoare

Incuietoare alimentata intern

Atentie:

1. Aveti nevoie de incuietoare Fail-secure
2. Alimentare interna de 12V si consumul nu trebuie sa depaseasca 250mA
3. Butonul de iesire nu are temporizare (EB)
4. Parametrul **Unlock Mode** trebuie sa fie setat pe 0 pe postul de interior (implicit)

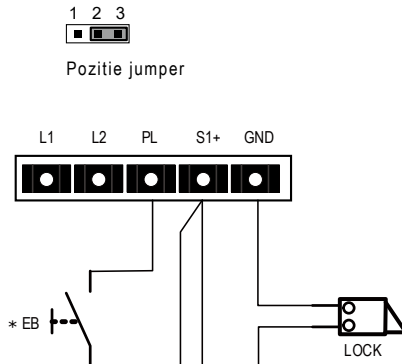

Incuietoare alimentata prin contacte uscate

Atentie:

1. Sursa de alimentare externa trebuie sa corespunda cerintelor
2. Tensiunea maxima pe releu AC/DC 24V, 1A
3. Eliminati jumperul inainte de instalare
4. Setati **Unlock Mode** (tipul incuietorii):
 - Yala Fail-secure :Unlock Mode=0 (initial)
 - Yala Fail-safe :Unlock Mode=1

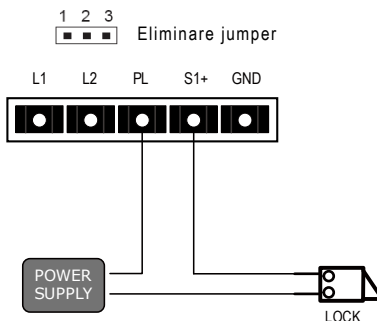

Parametrii de deschidere usa

- In meniul principal, apasati **[Logo]** si selectati **About**
- Tastati si mentineti apasat timp de 2 secunde **[UNLOCK]**
- Se afiseaza tastatura

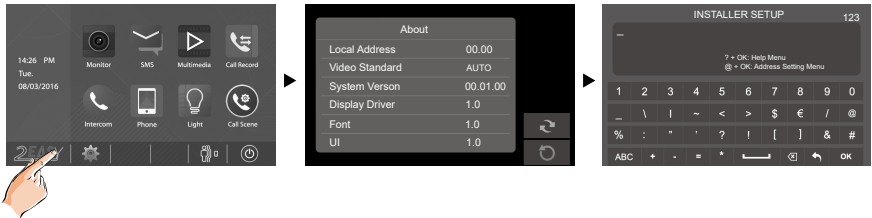

Atentie:

1. Faceti conexiunile corect inainte de setare
2. Daca faceti setarea de mai sus pe un singur post de interior, este de ajuns deoarece modificarile se vor face automat pe panoul de apel.
3. Pentru informatii amanuntite consultati manualul postului de interior.

Conexiuni cu mai multe panouri de apel

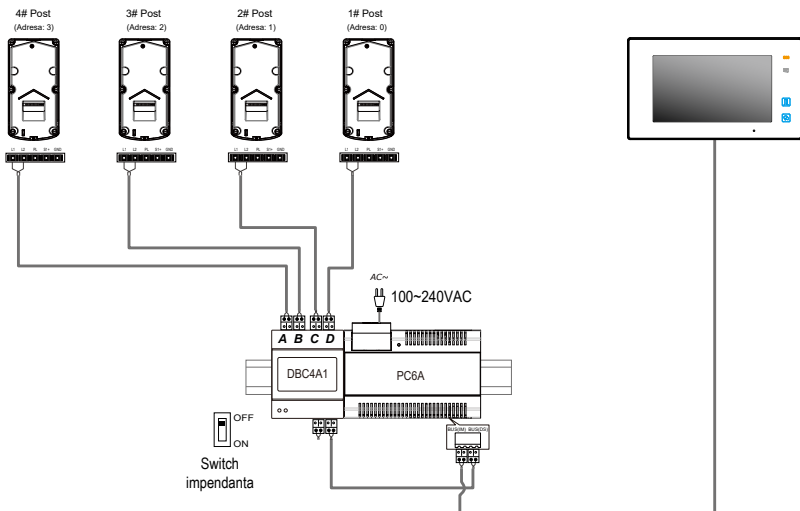

Conexiune cu mai multe posturi de interior

Conexiune de baza IN-OUT

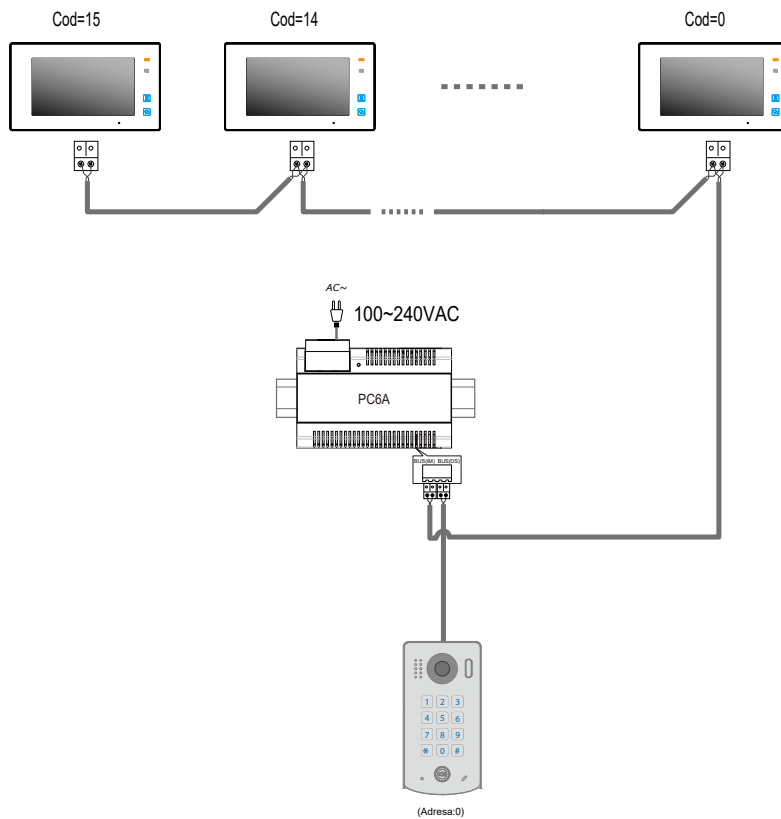

Conexiune cu DT-DBC4

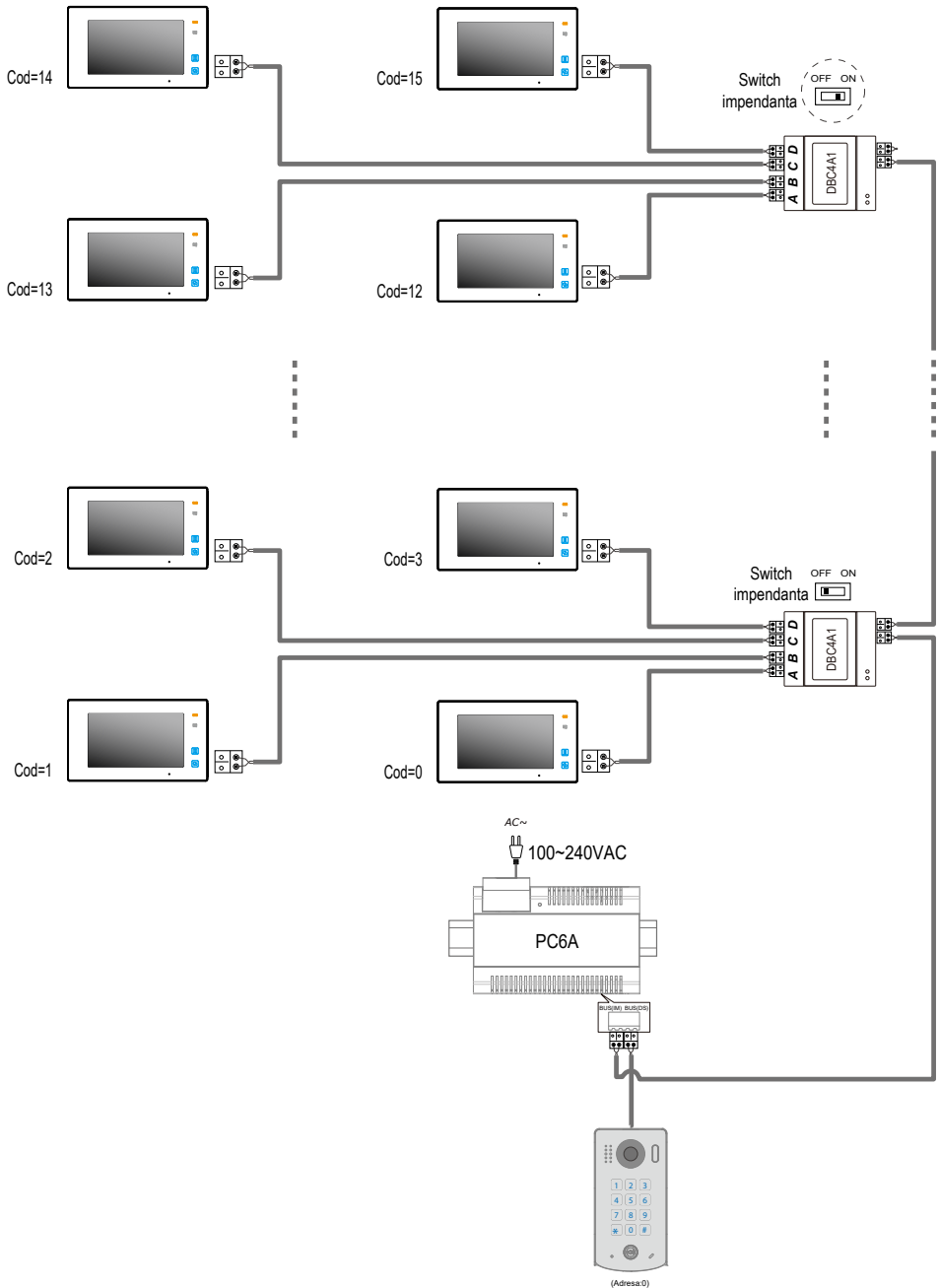

5. Pan-tilt & Zoom

Atentie: Aceste functii sunt suportate doar de postul exterior cu lentila fish-eye.

In momentul monitorizarii postului de exterior, ajustati imaginea cu ajutorul butoanelor dedicate sau faceti Zoom.

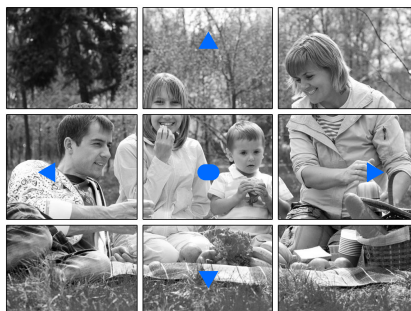

Monitorizare

Exemplu:

Apasati ● pentru a face Zoom in centru

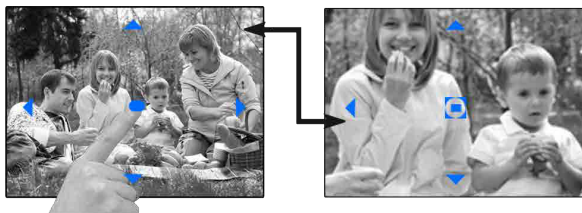

6. Configurare

Tastati codul master pentru a intra in modul de programare si introduceti codul corespunzator setarii dorite. Dupa introducerea codului aferent setarii dorite, apasati tasta “#” dupa care introduceti valoarea dorita. Pentru iesire din modul de programare apasati tasta “*”.



- Tasta * are functia de anulare, iar tasta # are functia de confirmare.
- Evitati alunecarea cu degetele pe tastatura pentru a nu introduce un cod eronat. Folositi degetele pentru a apasa tasta dorita.
- Trebuie apasata tasta de confirmare # dupa introducerea fiecarui cod, in caz contrar, operatiunea se va anula dupa 10 secunde.

Nr.Crt.	Funcctie	Valoare	Valoare implicita	Cod
1	Resetare generala	1234	-	00
2	Setarea codului master	1 ~ 12 cifre Taste valide: 0 ~ 9	1234	01
3	Setarea timpului de iluminare a tastaturii	10 - 99 secunde/ 0(iluminare continua)	10 secunde	02
4	Setarea timpului de deschidere	1 - 99 secunde	1 secunda	03
5	Setarea modului de deschidere	0:Deschis/1:Inchis	Deschis	04
6	Ton tastatura	0:Pornit/1:Oprit	Pornit	05
7	Resetare setari coduri	1234	-	06
8	*&# setare functii	0:Normal/1:Invers	Normal	07
9	Setare limba	Taste valide:0~9	Activat	08
10	Ajustare volum voce	Taste valide:0~9	5	09

11	Ajustare volum microfon	Taste valide: 0~9	7	10
12	Ajustare volum difuzor	Taste valide: 0~9	4	11
13	Adresa dispozitiv	Taste valide: 0~3	0	12
14	Nivel lumina de noapte	Taste valide: 0~5	4	13
15	Rezervat (<u>nefolosit</u>)	Rezervat	Rezervat	14~17
16	Setare cod temporar 1	1 ~ 12 cifre Taste valide: 0~9	-	18
17	Setare cod temporar 2	1 ~ 12 cifre Taste valide: 0~9	-	19
18	Setare primul grup de coduri de utilizator	1 ~ 12 cifre Taste valide: 0~9	-	20~59
19	Setare al doilea grup de coduri de utilizator	1 ~ 12 cifre Taste valide: 0~9	-	60~99
20	Mod de lucru	0: Apartament /1:Vila	1(Vila)	100
21	Adresa apelare	Taste valide: 0 - 9	Vila:00,16 Apartament:00~31	101



Fiecare operatie este indicata de LED-ul de alimentare, precum si de buzzer.

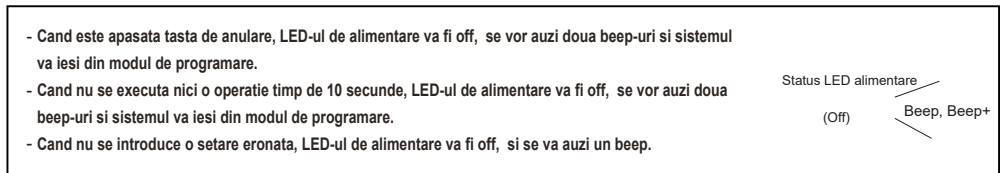
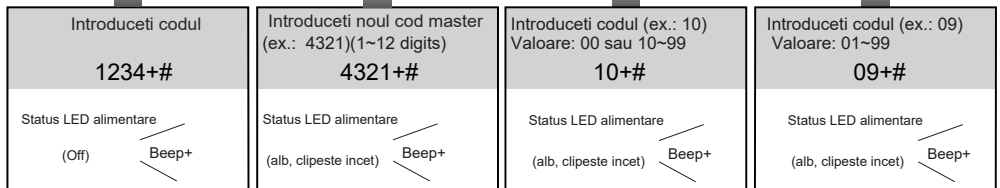
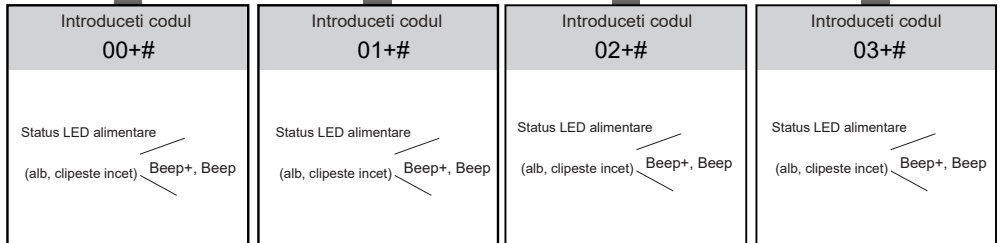
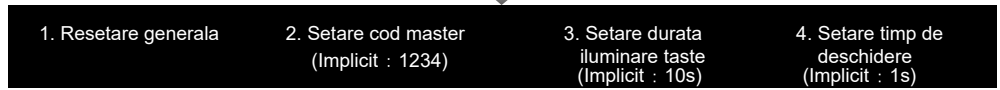

- Toate setarile vor reveni la valoarea implicita.

- La alimentarea sau cand se executa o resetare generala se va face o verificare a tastaturii, iar in acest timp, LED-ul de alimentare va deveni on - off - on si tastele nu vor functiona.

Dupa terminarea verificarii, LED-ul va fi off si se va auzi un beep lung.

- Codul master poate avea maxim 12 cifre si nu poate fi acelasi ca si codul de utilizator.

Este recomandat sa schimbati codul master.

- Daca timpul de iluminare tastatura este setat pe 00, tastatura va fi iluminata continuu.

- Daca timpul de iluminare tastatura este setat la o valoare de la 10 la 99, tastatura va fi iluminata intre 10 si 99 secunde. In acest mod, tastatura nu va fi iluminata in modul repaus, iar prima atingere a tastelor va activa iluminarea, dar tasta apasata va fi invalida in formarea codului, aceasta necesitand sa fie reapasata daca e cazul.

- Durata deschidere usa poate fi setata atat pe postul de apel cat si pe monitor, iar valoarea valida va fi cea introdusa ultima data.

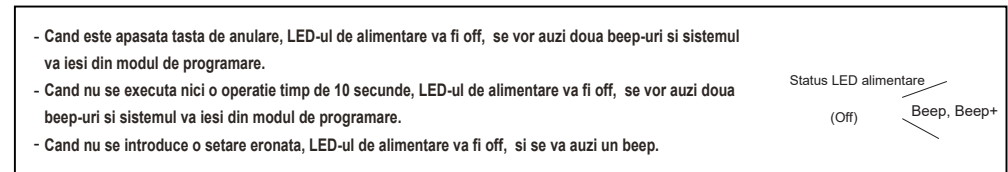
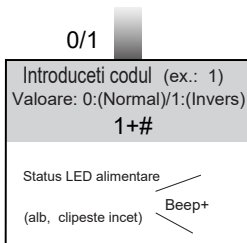
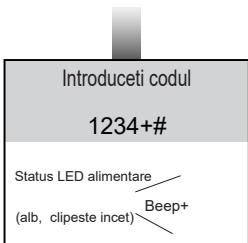
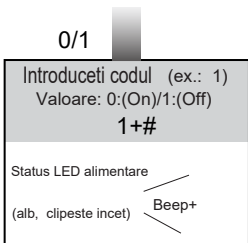
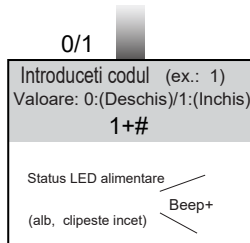
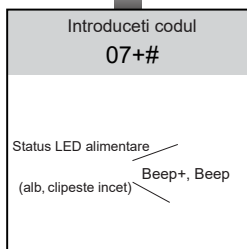
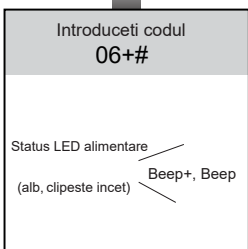
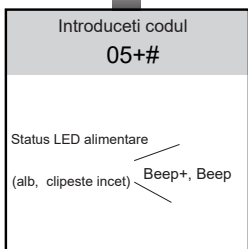
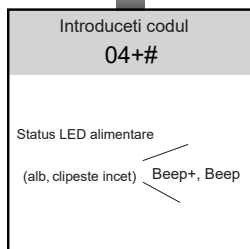
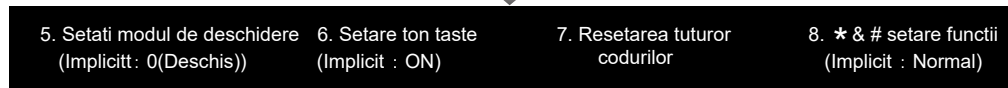

- Modul de deschidere poate fi setat atat de pe postul de apel cat si de pe postul interior, iar valoarea valida va ramane cea introdusa ultima data.

- Cand este introdus codul 0, la apasarea oricarei taste se va auzi un beep.
- Cand este introdus codul 1, la apasarea oricarei taste, tastatura va clipi.

- Anuleaza toate parolele cu exceptia codului master.
- Restabileste codul master la valoarea implicita(1234)

- Cand este introdus codul 0, tasta * are functia de anulare, iar tasta # are functia de confirmare
- Cand este introdus codul 1, tasta # are functia de anulare, iar tasta * are functia de confirmare.

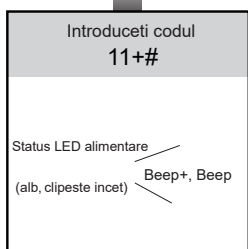
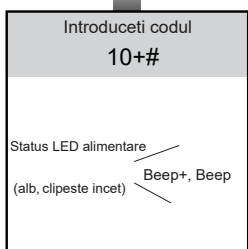
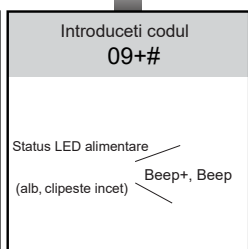
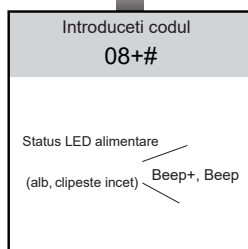

0/1

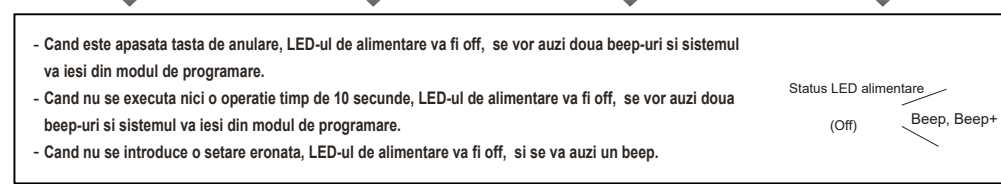
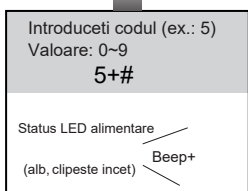
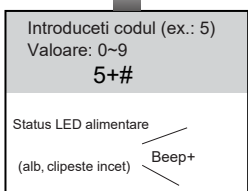
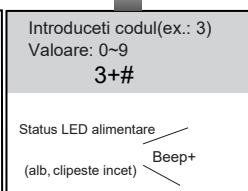
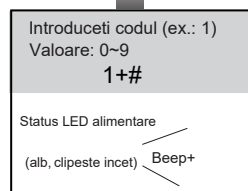

- Deschiderea cu cod de deblocare este disponibila chiar si in timpul convorbirii.
- In timpul convorbirii, introduceti codul master (lumina tastaturii se va schimba in alb) pentru a activa functia de ajustare volum:
 - Ajustare microfon: 1 (crestere volum), 4 (scadere volum);
 - Ajustare difuzor: 3 (crestere volum), 6 (scadere volum).

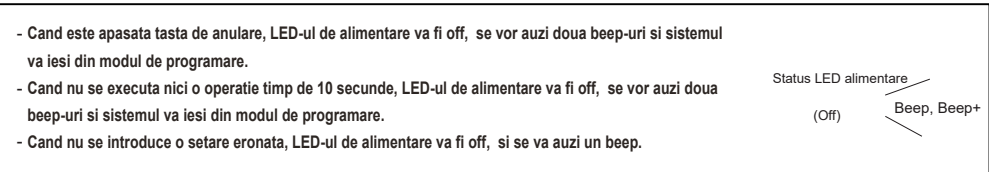
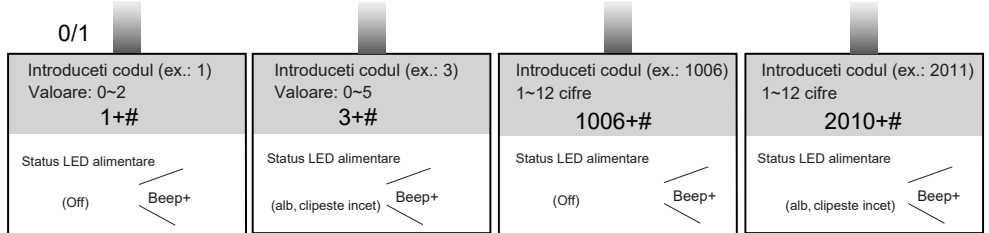
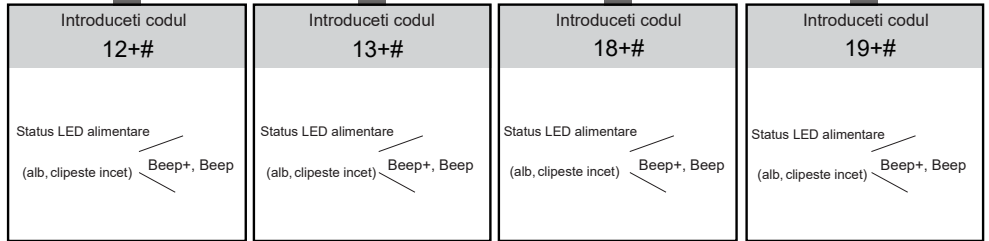
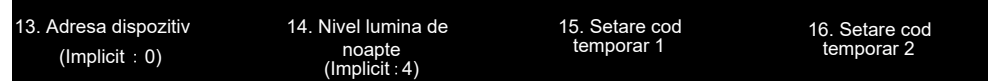



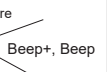
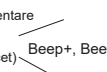
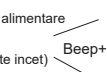
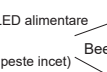

- Adresa dispozitiv: 0(adresa: 0), 1(adresa: 1), 2(adresa: 2), 3(adresa: 3).
- Nivel intensitate lumina de noapte:0~5.
- Cu cat este mai mare numarul, cu atat intensitatea luminii va fi mai puternica.
- Dupa 60 de secunde de la introducerea parolei temporare de deschidere a usii, aceasta va fi stearsa automat de catre sistem. Parola temporara este valabila 60 de secunde de la prima utilizare.
- Prima parola temporara este folosita pentru a deschide prima incuietoare, iar cea de-a doua parola temporara este folosita pentru a deschide a doua incuietoare (pentru ca echipamentul sa suporte a doua incuietoare este nevoie de un dispozitiv suplimentar).
- Daca parola depaseste 12 cifre, sistemul va emite o serie de beep-uri "beep,beep,beep,beep", iar cifrele introduse vor fi sterse automat.
- Codul temporar trebuie sa fie diferit de codul master si de codurile de utilizatori.

Introduceti codul master. (Implicit: [1 2 3 4]+[#])	Status LED alimentare (alb, clipeste incet) 
--	--

17. Setare primul grup de coduri de utilizator	18. Setare al doilea grup de coduri de utilizator	19. Mod de lucru (Implicit: 1/Vila)	20. Setare adresa apelare (Implicit: Vila:00,16; Apartment:00~31)
--	---	--	---

20~59	60~99	100+#	101+#
Introduceti codul. (ex.:21) 21+#	Introduceti codul. (ex.:60) 60+#	Introduceti codul. 100+#	Introduceti codul. 101+#
Status LED alimentare (alb, clipeste incet) 	Status LED alimentare (alb, clipeste incet) 	Status LED alimentare (alb, clipeste incet) 	Status LED alimentare (alb, clipeste incet) 

Introduceti codul (ex.: 2011) 1~12 cifre 2011+#	Introduceti codul (ex.: 2012) 1~12 cifre 2012+#	Introduceti codul (ex.: 1) Valoare:0(Apartment)/1:(Vila) 0+#	Introduceti codul (ex.: 1) Taste valide: 0 - 9 0+#
Status LED alimentare (alb, clipeste incet) 	Status LED alimentare (alb, clipeste incet) 	Status LED alimentare (alb, clipeste incet) 	Status LED alimentare (alb, clipeste incet) 

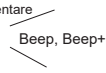
<ul style="list-style-type: none"> - Cand este apasata tasta de anulare, LED-ul de alimentare va fi off, se vor auzi doua beep-uri si sistemul va iesi din modul de programare. - Cand nu se executa nici o operatie timp de 10 secunde, LED-ul de alimentare va fi off, se vor auzi doua beep-uri si sistemul va iesi din modul de programare. - Cand nu se introduce o setare eronata, LED-ul de alimentare va fi off, si se va auzi un beep. 	Status LED alimentare (Off) 
--	---

- Primul grup de coduri de utilizator este folosit pentru primei incuietori, iar cel de-al doilea grup de coduri de utilizator este folosit pentru a deschide a doua incuietoare (pentru ca echipamentul sa suporte a doua incuietoare este nevoie de un dispozitiv suplimentar).
- Grupurile de coduri pot avea maxim 40 de parole, fiecare.
- Daca parola depaseste 12 cifre, sistemul va emite o serie de beep-uri "beep,beep,beep,beep", iar cifrele introduse vor fi sterse automat.
- Codul de utilizator trebuie sa fie diferit de codul master si de codul temporar.
- Setare mod de lucru: 0(Apartment)/1:(Vila).
- Cand modul de lucru este setat pe vila, adresa este in intervalul:00 - 16.
- Cand modul de lucru este setat pe apartament, adresa este in intervalul: 00-31

7. Operatiuni deschidere usa

Deblocare cu cod de acces

Dupa ce a fost introdus codul de acces, tastatura isi va schimba culoarea, se va auzi un beep, iar incuietoarea se va deschide (butonul de confirmare #, trebuie apasat dupa fiecare introducere a unui cod de acces).

- Intervalul de apasare a tastelor este de maxim 10 secunde. Daca timp de 10 secunde nu se apasa nicio tasta, tastele apasate anterior se vor sterge.
- Daca se greseste la introducerea codului de acces, se apasa tasta de anulare, dupa care se reintroduce codul.
- Daca este introdus un cod gresit de 10 ori, timp de 60 de secunde nu va mai fi acceptat nici un alt cod, iar echipamentul va emite 8 beep-uri consecutive.



1. In timpul apelului, apasarea tastei de anulare intrerupe apelul.
2. Daca este introdus un cod de acces gresit se vor auzi 3 beep-uri.

8. Specificatii

- Tensiune de alimentare: 24Vcc (BUS)
- Consum: Repaus 15mA; In functionare 105mA
- Camera video: Color CMOS, 2.0 Mega pixel
1/2.7" fisheye camera, 170° wide angle
- Temporizare incuietoare: 1~99 secunde
- Alimentare incuietoare: 12Vcc, max. 280mA
- Numar rele: 1
- Instalare: Aplicat (DT611-MK)
Incastrat (DT611F-MK)
- Temperatura de functionare: -15°C ~ +55°C
- Dimensiuni: 182(H)×93(L)×44(A)mm (DT611-MK)
220(H)×120(L)×50(A)mm (DT611F-MK)

9. Lungime cablare

Distanța de cablare este limitată în sistemele DT. Dacă folosiți tipuri diferite de cablu, se poate modifica distanța maximă de cablare.

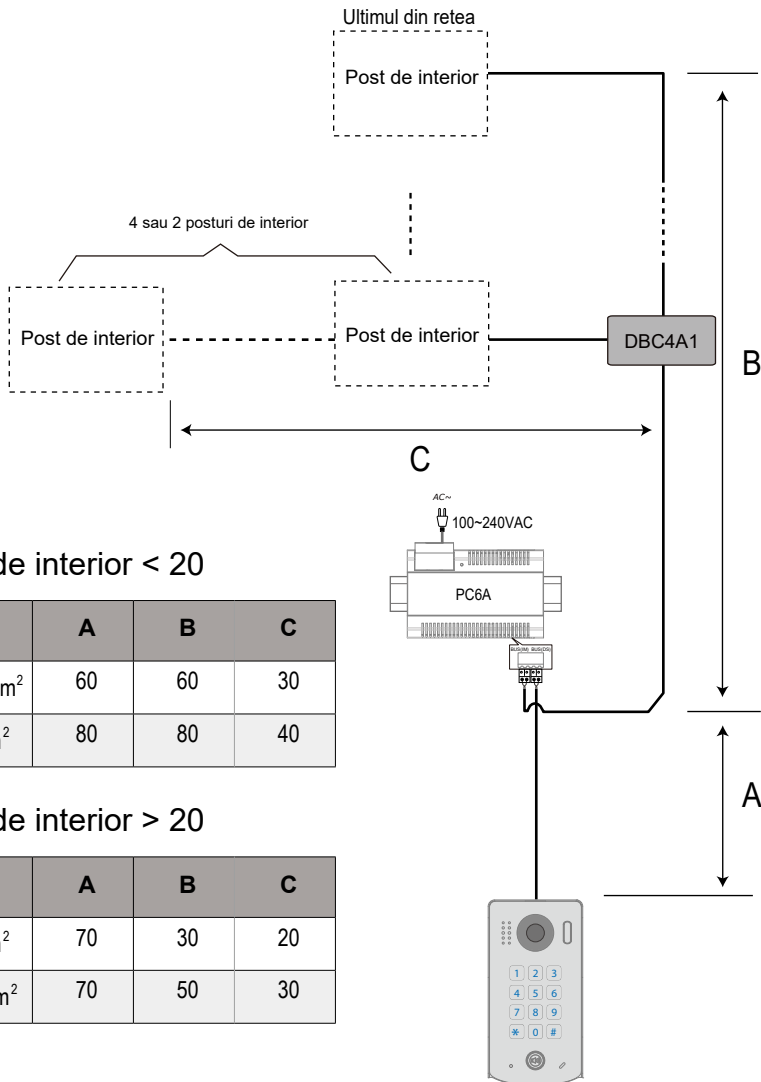

Numar posturi de interior < 20

Cablu utilizat	A	B	C
Cablu torsadat 2x0.75 mm ²	60	60	30
Cablu torsadat 2x1 mm ²	80	80	40

Numar posturi de interior > 20

Cablu utilizat	A	B	C
Cablu torsadat 2x1 mm ²	70	30	20
Cablu torsadat 2x1.5 mm ²	70	50	30

10. Attentionari

- Curatati unitatea cu bumbac moale si nu folositi agenti chimici. Daca este necesar folositi sapun diluat cu apa pentru a curata praful.
- Unitatea este rezistenta la apa dar NU aplicati jeturi de apa direct spre unitate. Umiditatea ridicata poate cauza probleme.
- Folositi sursa de alimentare oferita de producator.
- Adresati-va personalului calificat pentru probleme tehnice.

Designul și specificațiile pot fi modificate fără notificarea în prealabil a utilizatorilor.
Drepturile de autor ale acestui manual sunt rezervate.