

# **IP Indoor Monitor**

## **User's Manual**





# Foreword

## General

This document mainly introduces structure, installation process, and basic configuration of the IP Indoor Monitor (hereinafter referred to as the "indoor monitor").

## Safety Instructions

The following categorized signal words with defined meaning might appear in the manual.

Signal Words	Meaning
 <b>CAUTION</b>	Indicates a potential risk which, if not avoided, could result in property damage, data loss, lower performance, or unpredictable result.
 <b>NOTE</b>	Provides additional information as the emphasis and supplement to the text.

## Revision History

Version	Revision Content	Release Date
V1.0.0	First release	April 2020

## About the Manual

- The manual is for reference only. If there is inconsistency between the manual and the actual product, the actual product shall prevail.
- We are not liable for any loss caused by the operations that do not comply with the manual.
- The manual would be updated according to the latest laws and regulations of related regions. For detailed information, see the paper manual, CD-ROM, QR code or our official website. If there is inconsistency between paper manual and the electronic version, the electronic version shall prevail.
- All the designs and software are subject to change without prior written notice. The product updates might cause some differences between the actual product and the manual. Please contact the customer service for the latest program and supplementary documentation.
- There still might be deviation in technical data, functions and operations description, or errors in print. If there is any doubt or dispute, please refer to our final explanation.
- Upgrade the reader software or try other mainstream reader software if the manual (in PDF format) cannot be opened.
- All trademarks, registered trademarks and the company names in the manual are the properties of their respective owners.
- Please visit our website, contact the supplier or customer service if there is any problem occurred when using the device.
- If there is any uncertainty or controversy, please refer to our final explanation.

# Important Safeguards and Warnings

The following description is the correct application method of the device. Read the manual carefully before use to prevent danger and property loss. Strictly conform to the manual during application and keep it properly after reading.

## Operating Requirement

- Do not place and install the device in an area exposed to direct sunlight or near heat generating device.
- Do not install the device in a humid, dusty or fuliginous area.
- Keep its horizontal installation, or install it at stable places, and prevent it from falling.
- Do not drip or splash liquids onto the device; do not put on the device anything filled with liquids to prevent liquids from flowing into the device.
- Install the device at well-ventilated places; do not block its ventilation opening.
- Use the device only within rated input and output range.
- Do not dismantle the device arbitrarily.
- The device shall be used with screened network cables.

## Power Requirement

- The product shall use electric wires (power wires) required by the region where the device will be used.
- Use power supply that meets SELV (safety extra low voltage) requirements, and supply power with rated voltage that conforms to Limited Power Source in IEC60950-1. For specific power supply requirements, refer to device labels.
- Appliance coupler is a disconnecting device. During normal use, keep an angle that facilitates operation.
- Do not cut off power supply during device upgrade.

# Table of Contents

<b>Foreword</b> .....	<b>I</b>
<b>Important Safeguards and Warnings</b> .....	<b>II</b>
<b>1 Introduction</b> .....	<b>1</b>
1.1 Overview .....	1
1.2 Features .....	1
1.3 Front Panel.....	2
1.4 Rear Panel .....	3
1.5 Cable Connections.....	5
<b>2 Installation</b> .....	<b>6</b>
<b>3 Network Diagram</b> .....	<b>9</b>
<b>4 Configuration</b> .....	<b>10</b>
4.1 Configuration Process .....	10
4.2 VDPConfig.....	10
4.3 Configuring Door Station.....	10
4.3.1 Initialization .....	10
4.3.2 Configuring VTO Number .....	11
4.3.3 Configuring Network Parameters.....	12
4.3.4 Selecting SIP Servers .....	13
4.3.5 Adding VTO Devices .....	15
4.3.6 Adding Room Number.....	16
4.4 Configuring Indoor Monitor .....	17
4.4.1 Initialization .....	18
4.4.2 Network Settings .....	24
4.4.3 Project Settings.....	27
4.4.4 General Settings.....	33
4.5 Alarm .....	38
4.5.1 Alarm Record .....	38
4.5.2 Alarm Settings.....	39
4.5.3 Alarm Mode .....	43
4.6 Unlocking.....	44
4.7 Arm/Disarm.....	44
4.7.1 Arm.....	44
4.7.2 Disarm.....	45
4.8 Elevator Control.....	45
4.9 Commissioning .....	45
4.9.1 Watching Monitoring Videos .....	45
4.9.2 Checking Messages.....	47
4.9.3 Making Calls.....	49
<b>Appendix 1 Cybersecurity Recommendations</b> .....	<b>51</b>

# 1 Introduction

## 1.1 Overview

The 10-inch IP indoor monitor, widely used in intelligent buildings, integrates functions of monitoring, voice/video call, and unlock. Technologies like embedded technology, IP communication methods, simple network management protocol (SNMP), network encryption, and more are applied to make the whole system more stable, safer, and easier to be managed.

## 1.2 Features

- Wi-Fi: Provides wireless network for devices.
- Voice call: You can make calls on the door stations to indoor monitors.
- Monitoring: Videos captured by fence stations, door stations, IP cameras, and more can be watched on the indoor monitor.
- Elevator control: You can make the elevator come to your floor through the indoor monitor.
- Emergency call: Emergency calls can be made on the indoor monitor.
- Auto snapshot: During calls, or during monitoring, images can be captured, and the images can be stored in the SD card.
- Video recording: You can record videos through the indoor monitor if SD card is inserted into the rear panel of the indoor monitor.
- Do not disturb: You can set period in which you do not want to be disturbed.
- Remote unlock: You can unlock doors remotely.
- Arm and disarm: You can set alarm areas, and then arm and disarm.
- Record search: Call records and alarm records can be viewed.
- Message check: You can check text messages and videos left by visitors, or public notices released by the management center.
- App: You can install app on your mobile phone, and then you can unlock doors, making calls, receive alarm messages, and more through the app.

# 1.3 Front Panel

10 Inch

Figure 1-1 Front panel [mm (inch)]

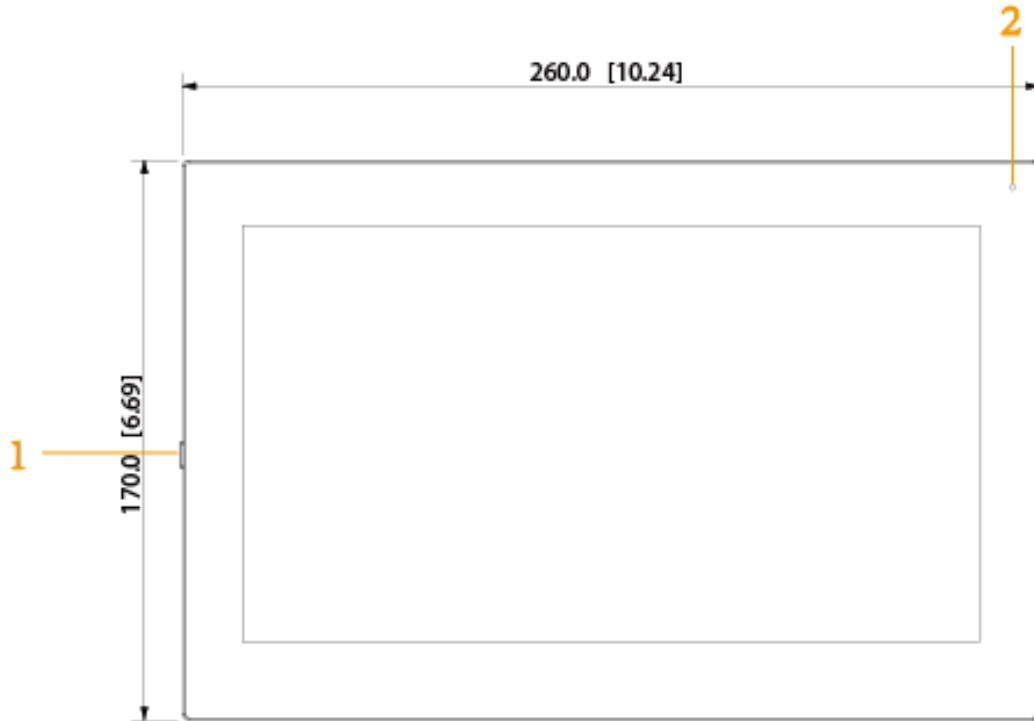

7 Inch

Figure 1-2 Front panel [mm (inch)]

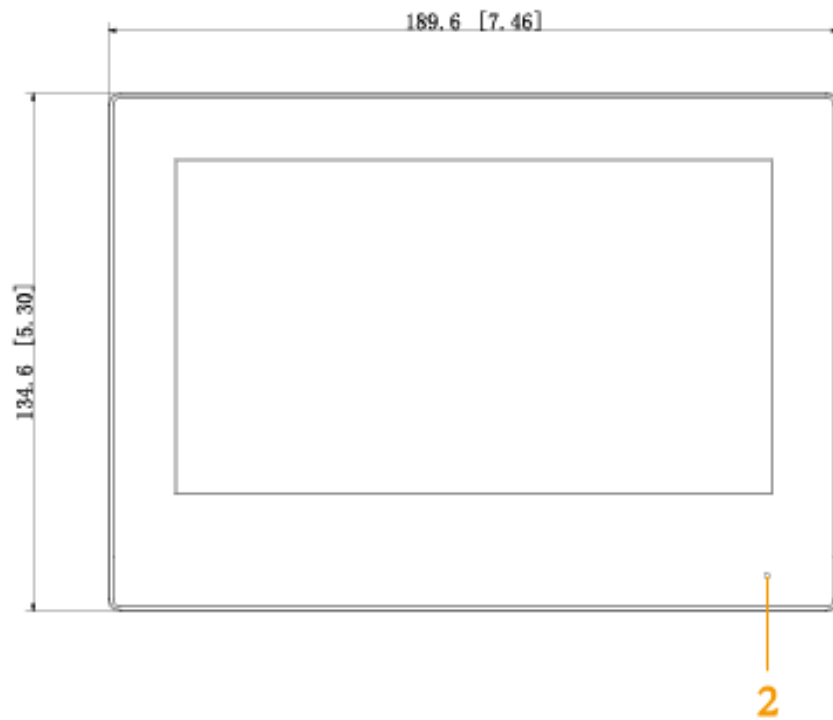

Table 1-1 Components

No.	Name
1	On/off button. Press the button, and then you can turn on/off the screen; press and hold the button, you can turn on/off or restart the indoor monitor.
2	MIC, inputs audio.

## 1.4 Rear Panel

10 Inch

Figure 1-3 Rear panel

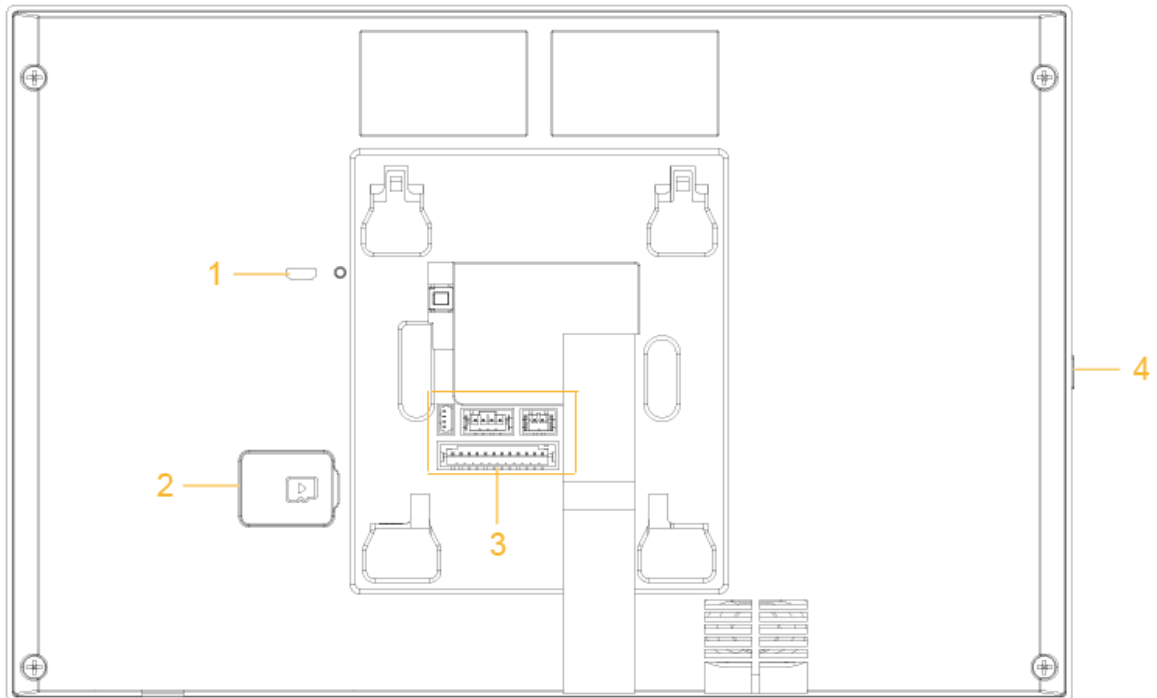

7 Inch

Figure 1-4 Rear panel

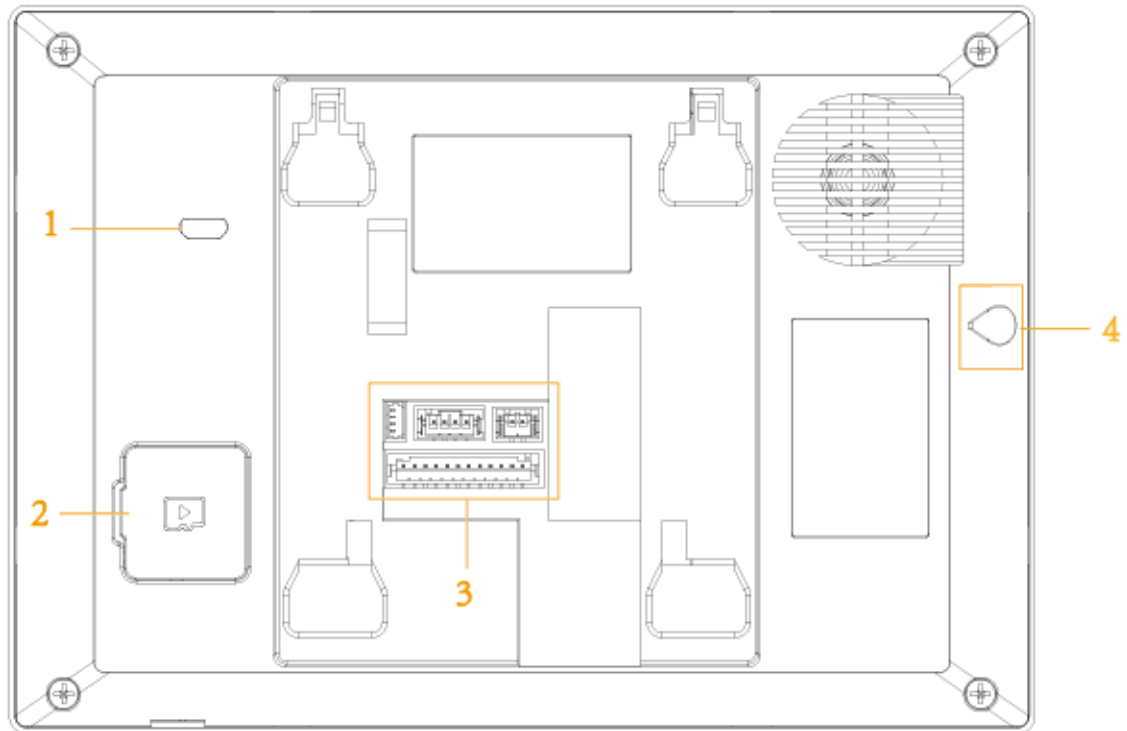

Table 1-2 Rear panel description

No.	Description
1	USB port, used by project personnel.
2	SD card slot.
3	Alarm ports, power cables, RS-485 port, and network ports are under the cover.
4	On/off button. Press the button, and then you can turn on/off the screen; press and hold the button, you can turn on/off or restart the indoor monitor.



# 1.5 Cable Connections

Figure 1-5 Cable connection

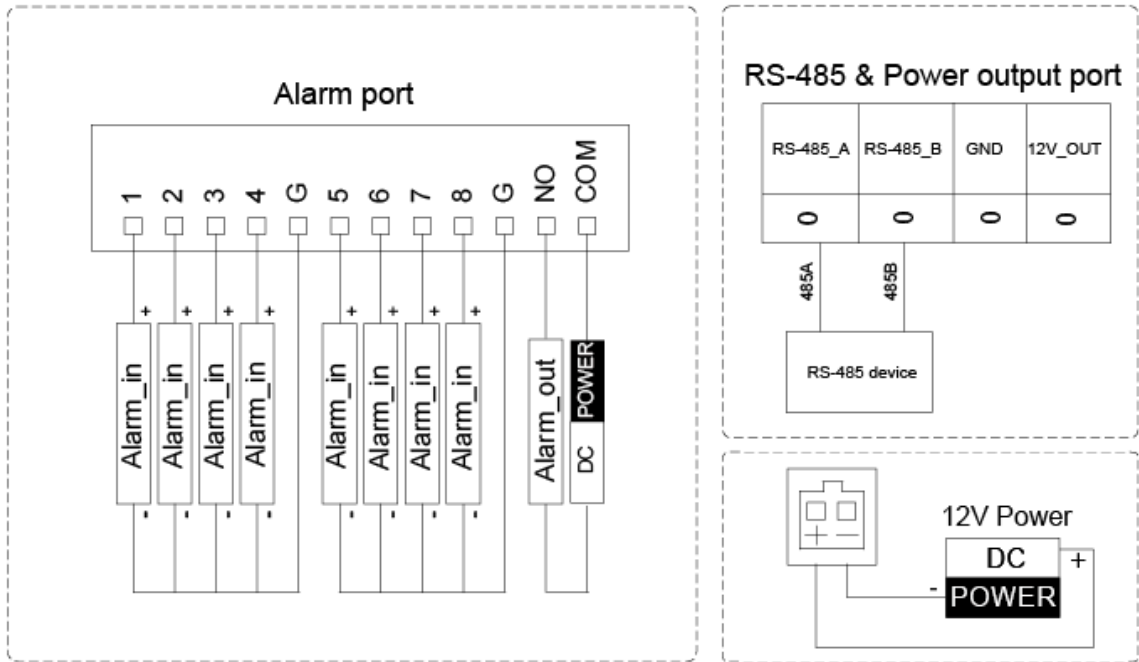

# 2 Installation

10 Inch

Figure 2-1 Installation

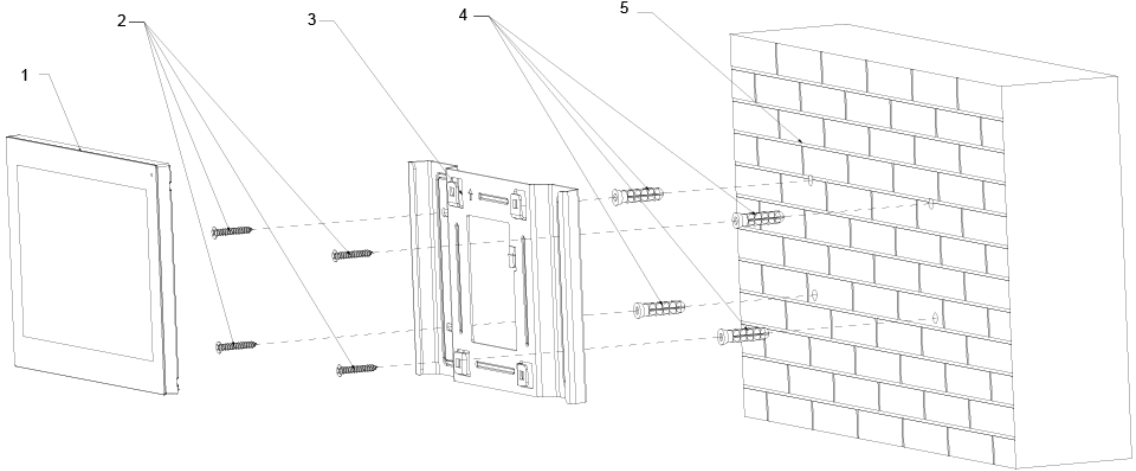

Table 2-1 Components

No.	Name	No.	Name
1	Indoor monitor	4	Anchor bolt
2	ST3 self-tapping screws	5	Wall
3	Bracket	-	-

Figure 2-2 Screw hole distances and diameters [mm]

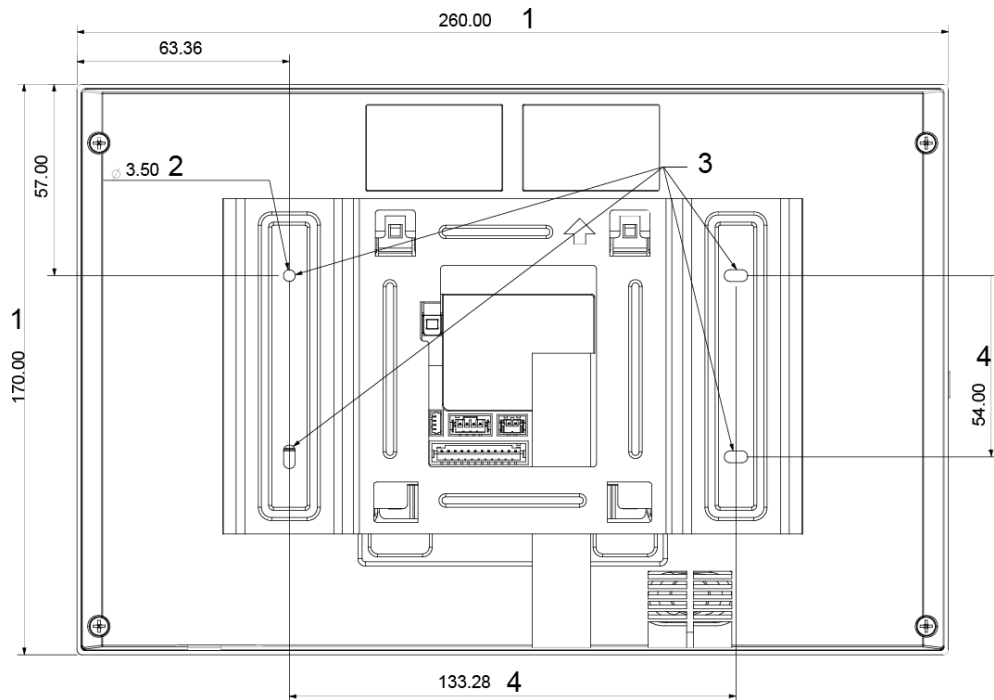

Table 2-2 Description of screw hole distances and diameters

No.	Description
1	Indoor monitor dimension
2	Bracket screw hole diameter

No.	Description
3	Bracket oval hole position
4	Screw hole distance

**Step 1** Drill four screw holes in the wall according to holes on the bracket.

**Step 2** Put anchor bolts into the screw holes.

**Step 3** Fix the bracket on the wall with screws.

**Step 4** Connect cables (power cable, network cables, and more).

**Step 5** Hang the indoor monitor on the bracket.

The installation is completed.

7 Inch

Figure 2-3 Installation

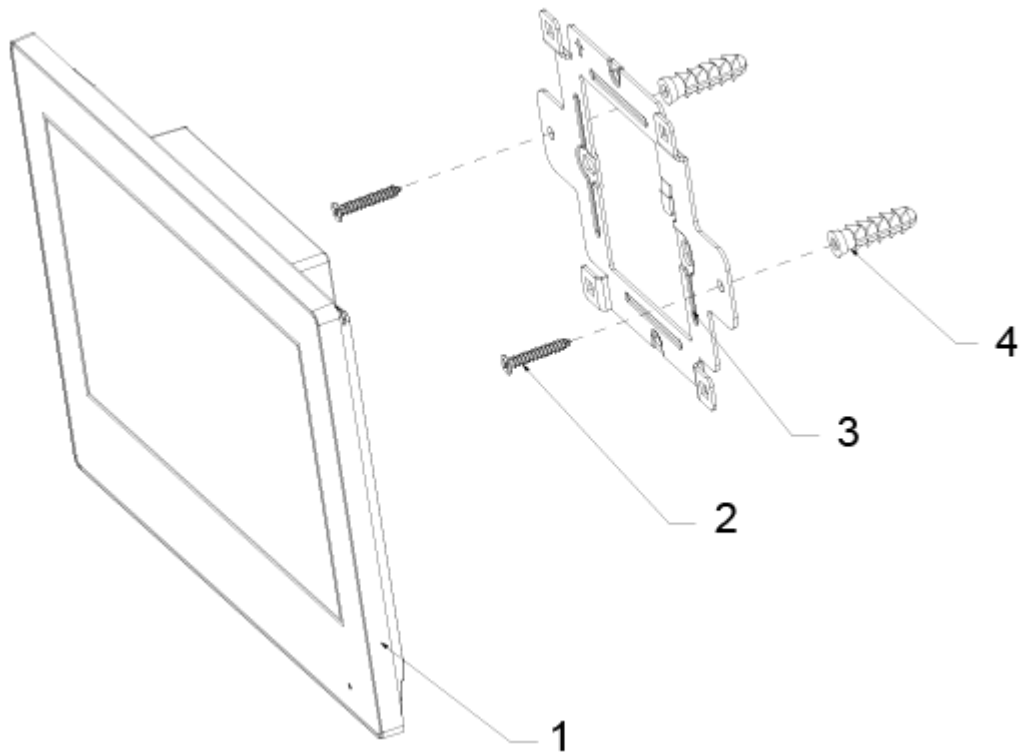
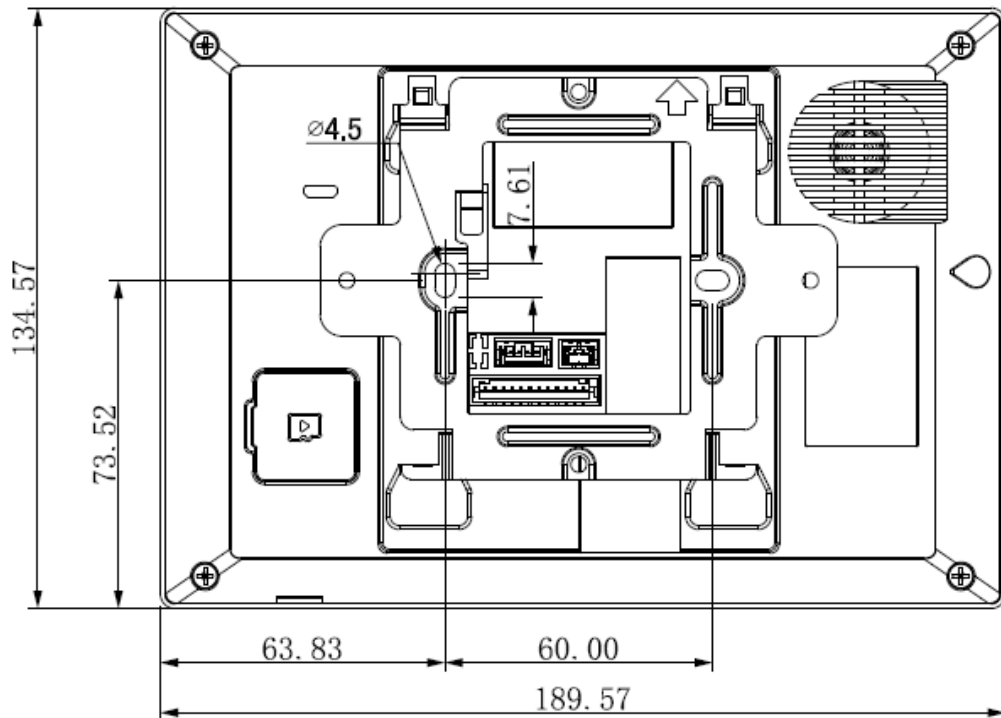

Table 2-3 Components

No.	Name	No.	Name
1	Indoor monitor	3	Bracket
2	Bracket fixing screws	4	Anchor bolt

Figure 2-4 Screw hole distances and diameters [mm]



- Step 1** Drill two screw holes in the wall according to holes on the bracket.
- Step 2** Put anchor bolts into the screw holes.
- Step 3** Fix the bracket on the wall with screws.
- Step 4** Connect cables (power cable, network cables, and more).
- Step 5** Hang the indoor monitor on the bracket.  
The installation is completed.

# 3 Network Diagram

Figure 3-1 Network diagram

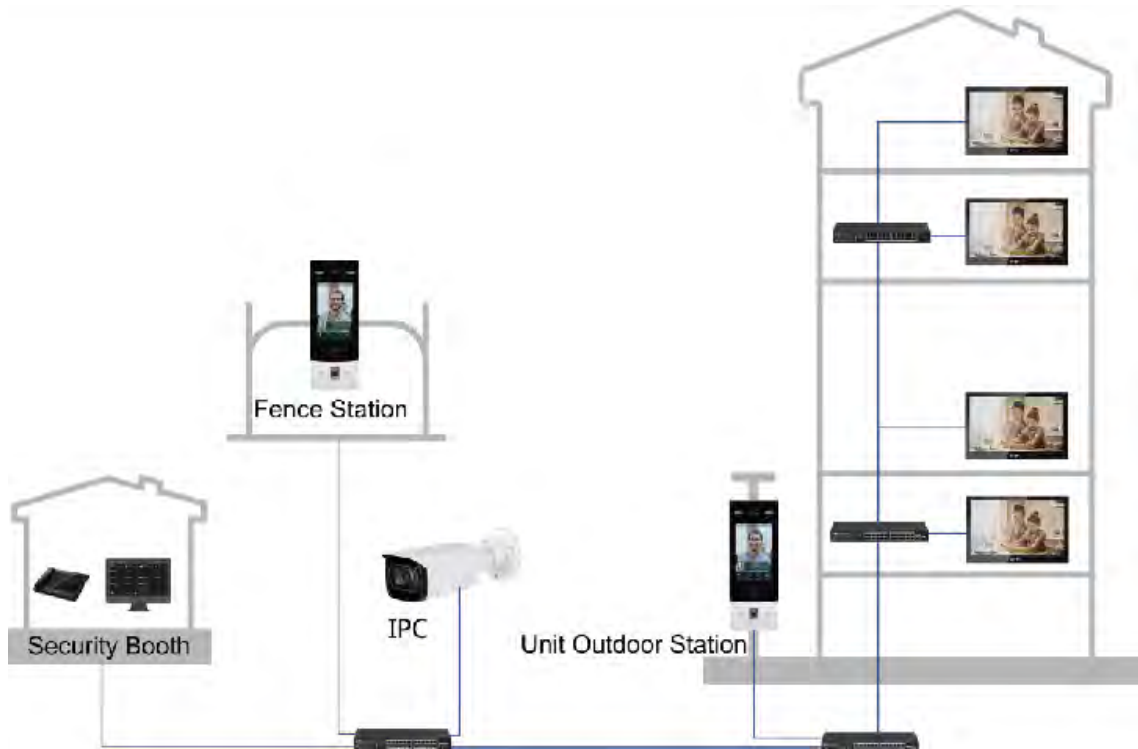

# 4 Configuration

This chapter introduces initialization, cable connection, and parameter configuration to realize basic functions, including device management, calling, and monitoring.

## 4.1 Configuration Process



Before configuration, make sure that there is no short circuit or open circuit.

**Step 1** Plan IP address for every device, and also plan the unit number and room number you need.

**Step 2** Configure VTO. See "4.3 Configuring Door Station."

- 1) Initialize door station (VTO). See "4.3.1 Initialization."
- 2) Configure door station (VTO). See "4.3.2 Configuring VTO Number."
- 3) Configure door station (VTO) network parameters. See "4.3.3 Configuring Network Parameters."
- 4) Configure SIP Server. See "4.3.4 Selecting SIP Servers."
- 5) Add door stations (VTO) to the SIP server. See "4.3.5 Adding VTO Devices."
- 6) Add room number to the SIP server. See "4.3.6 Adding Room Number."

**Step 3** Configure indoor monitor (VTH). See the VTH users' manual.

**Step 4** Commissioning. See "4.5 Commissioning."

## 4.2 VDPConfig

You can download the "VDPConfig" to initialize devices, change IP address and upgrade system for multiple devices at the same time. For the detailed information, see the VDPConfig user's manual.

## 4.3 Configuring Door Station

Connect the door station (VTO) to your PC with network cable, and for the first-time login, you need to create a new password for the web interface.

### 4.3.1 Initialization

The default IP address of VTO is 192.168.1.108, and make sure that the PC is in the same network segment as the VTO.

**Step 1** Connect the VTO to power source, and then boot it up.

**Step 2** Open the browser on the PC, enter the default IP address of the VTO in the address bar, and then press Enter on the keyboard.

Figure 4-1 Device initialization

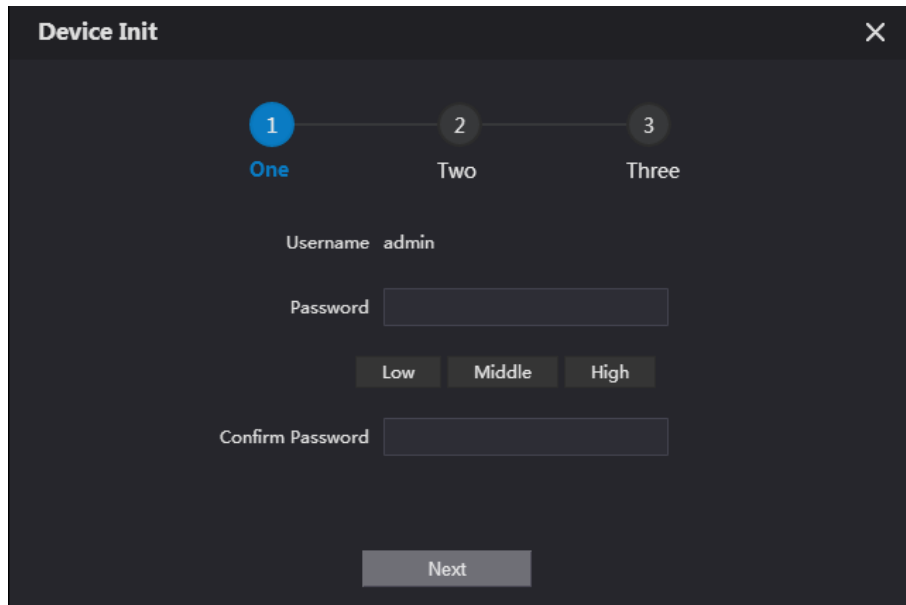

Step 3 Enter and confirm the password, and then click **Next**.

Step 4 Select the **email** check box, and then enter your email address. This email address can be used to reset the password.

Step 5 Click **Next**.

Step 6 Click **OK**.

Figure 4-2 Login interface

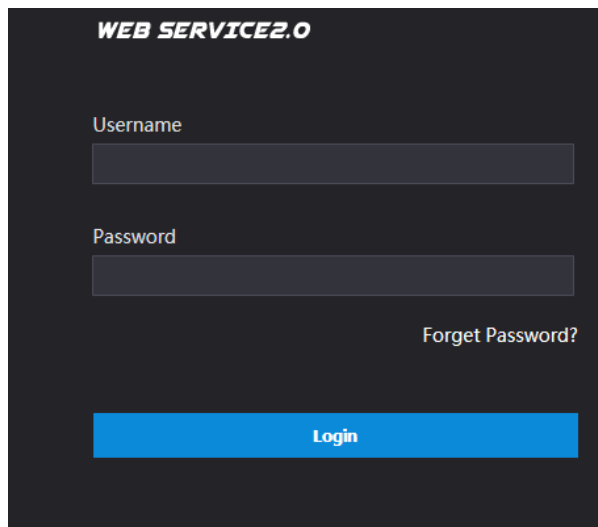

### 4.3.2 Configuring VTO Number

The VTO number can be used to differentiate each VTO, and it is normally configured according to building number.



- You can change the number of a VTO when it is not working as SIP server.
- The VTO number can contain 5 numbers at most, and it cannot be the same as any room number.

Step 1 Log in to the web interface of the VTO.

Figure 4-3 Main interface

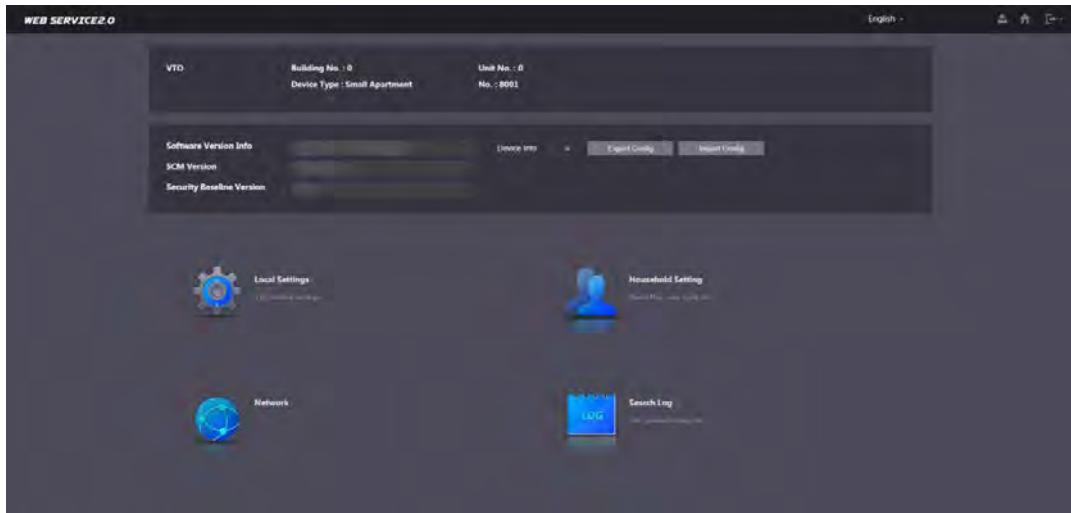

**Step 2** Select **Local Setting > Basic**.

Figure 4-4 Device properties

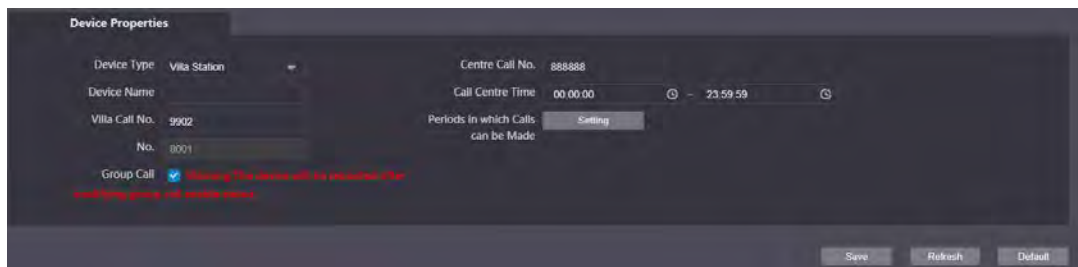

**Step 3** In the **VTO No.** input box, enter the VTO number you planned for this VTO, and then click **Confirm** to save.

### 4.3.3 Configuring Network Parameters

**Step 1** Select **Network Setting > Basic**.

Figure 4-5 TCP/IP information

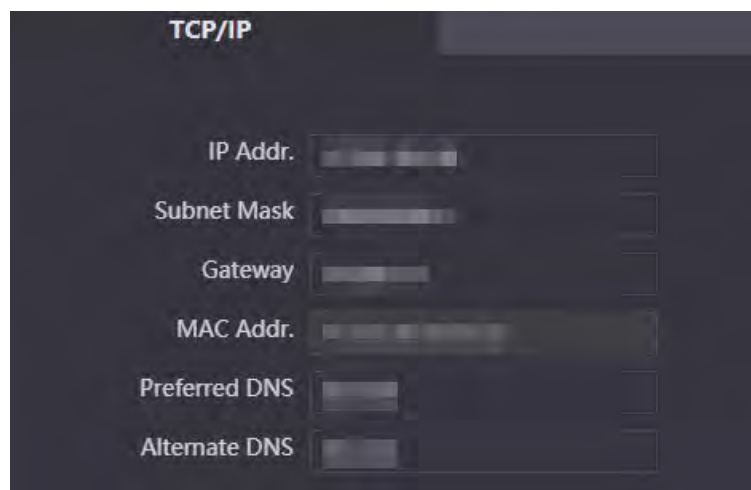

**Step 2** Enter network parameters you planned, and then click **Save**.

The VTO will restart.



Make IP addresses of your PC and VTO are in the same network segment.



### 4.3.4 Selecting SIP Servers

The Session Initiation Protocol (SIP) is used for signaling and controlling multimedia communication sessions in applications of voice and video calls. A SIP server is an application provides information or direction to a user agent.

- When the door station (VTO) you are operating or another door station (VTO) works as SIP server, select **VTO** from the **Server Type** drop-down list. It applies to a scenario where there is only one building.
- When the platform (Express/DSS) works as SIP server, select **Express/DSS** from the **Server Type** drop-down list. It applies to a scenario where there are multiple buildings or multiple units.

**Step 1** Log in to the web page.

**Step 2** On the homepage, select **Local Setting > Basic**.

- 1) Select **TCP/IP** from the **System Type** drop-down list.



Default system type is analog system and shall be changed to TCP/IP. Otherwise, it will fail to connect VTH.

- 2) Click **OK** to save the settings.

- 3) Restart the device manually, or wait for auto restart to make the settings effective.

**Step 3** Log in to web interface again.

**Step 4** Select **Network Setting > SIP Server**.

Figure 4-6 SIP server (1)

**Step 5** Select a SIP server.

#### VTO as SIP server

**Step 1** Select **Enable** next to **SIP Server**.

**Step 2** Select **VTO** from the **Server Type** drop-down list

**Step 3** Configure parameters.

Table 4-1 SIP server configuration

Parameter	Description
IP Addr.	The IP address of the VTO which works as SIP server.

Parameter	Description
Port	5060
Username	Keep the default value.
Password	
SIP Domain	VDP
SIP Server Username	The user name and password for the web interface of the SIP server.
SIP Server Password	

**Step 4** Click **Save**.

The VTO will restart automatically.

## Platform (Express/DSS) as a SIP server

**Step 1** Select **Network Setting > SIP Server**.

**Step 2** Select **Express/DSS** from the **Server Type** drop-down list.

**Step 3** Set parameters according to Table 4-2.

Table 4-2 SIP server parameter description

Parameter	Description
IP Address	IP address of SIP server.
Port	<ul style="list-style-type: none"> <li>It is 5060 by default when another VTO works as SIP server.</li> <li>It is 5080 by default when the platform works as SIP server.</li> </ul>
Username/Password	Use default value.
SIP Domain	<ul style="list-style-type: none"> <li>It shall be VDP when another VTO works as SIP server.</li> <li>It can be null or keep default value when the platform works as SIP server.</li> </ul>
SIP Server Username/Password	Username and password to log in to SIP server.
Alternate IP Addr.	IP address of the alternate server.  If alternate server is enabled and Express or DSS works as SIP server, when Express or DSS cannot work normally, the VTO will be used as the SIP server.
Alternate Username	Username and password for logging in to the alternate server.
Alternate Password	
Alternate VTS IP Addr.	IP address of the alternate VTS.
Alternate Server	<ul style="list-style-type: none"> <li>Select the <b>Enable</b> checkbox after Alternate Sever, and then the door station (VTO) you are visiting will work as the alternate SIP server.</li> <li>If you entered alternate IP address, username, password, and VTS IP address, and then the door station (VTO) whose IP address you entered will work as alternate SIP server.</li> </ul>

**Step 4** Click **OK** to save the configuration.

The VTO will restart automatically.



When the platform works as SIP server, if it is necessary to set Building No. and Building Unit No., enable **Support Building** and **Support Unit** first.

### 4.3.5 Adding VTO Devices

You need to add VTO to the SIP server, and all intercoms connected to the same SIP server can make video calls among each other. This section applies to the condition in which a VTO works as SIP server, and if you are using other servers as SIP server, see the corresponding manual for the detailed configuration.

**Step 1** Log in to the web interface of the SIP server, and then select **Household Setting > VTO No. Management**.

Figure 4-7 VTO No. management

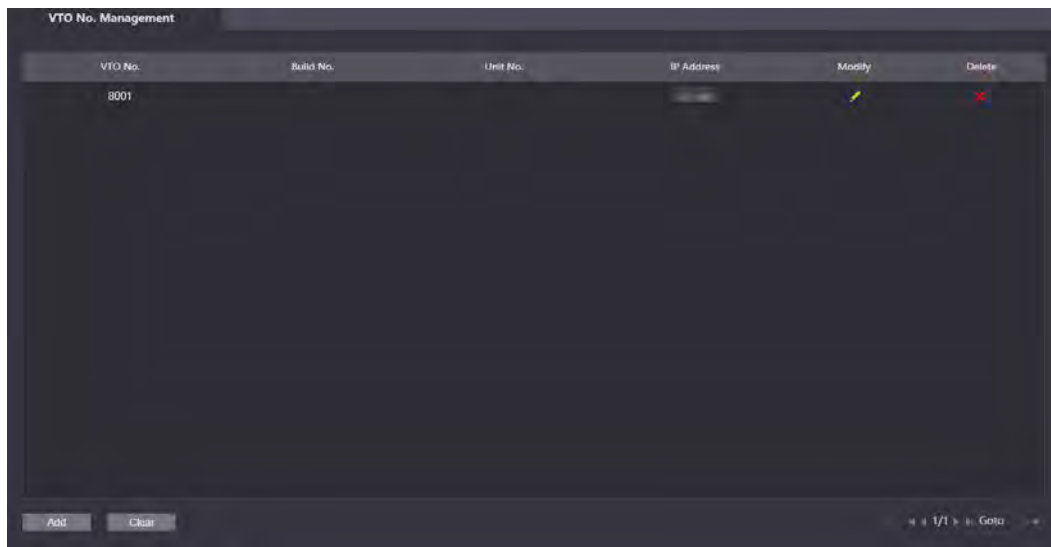

**Step 2** Click **Add**.

Figure 4-8 Add VTO

**Step 3** Configure the parameters, and be sure to add the SIP server itself too.

Table 4-3 Add VTO configuration

Parameter	Description
Rec No.	The VTO number you configured for the target VTO. See the details in "4.3.2 Configuring VTO Number."
Register Password	Keep default value.
Build No.	Available only when other servers work as SIP server.
Unit No.	
IP Address	IP address of the target VTO.
Username	The user name and password for the web interface of the target VTO.
Password	

**Step 4** Click **Save**.

### 4.3.6 Adding Room Number

You can add the planned room number to the SIP server, and then configure the room number on VTH devices to connect them to the network. VTO works as SIP server will be taken as an example, and if you use other servers as SIP server, see the corresponding manual for the details.



The room number contains 6 digits of numbers or letters or their combination at most, and it cannot be the same as any other VTO numbers.

**Step 1** Log in to the web interface of the SIP server, and then select **Household Setting > Room No. Management**.

Figure 4-9 Room No. management

Room No.	First Name	Last Name	Nick Name	Register Type	Modify
9901#0				public	[edit] [delete]
9901#1				public	[edit] [delete]
9901#2				public	[edit] [delete]
9901#3				public	[edit] [delete]
9901#4				public	[edit] [delete]
9901#5				public	[edit] [delete]
9901#6				public	[edit] [delete]
9901#7				public	[edit] [delete]
9901#8				public	[edit] [delete]
9901#9				public	[edit] [delete]
9902#0				public	[edit] [delete]

Buttons: Add, Refresh, Close. Page: 1/1, Go to

**Step 2** You can add single room number or do it in batches.

- Add single room number
- 1) Click **Add**. See Figure 4-9.

Figure 4-10 Add single room number

2) Configure room information.

Table 4-4 Room information

Parameter	Description
First Name	Enter the information you need to differentiate each room.
Last Name	
Nick Name	
Room No.	<p>The room number you planned.</p>  <ul style="list-style-type: none"> <li>If you use multiple VTH devices, the room number of the master VTH should be "room number#0", and the room number of the extension VTH should be "room number#1", "room number#2", and so on.</li> <li>You can have 10 extension VTH devices at most for one master VTH.</li> </ul>
Register Type	Select <b>public</b> , and <b>local</b> is reserved for future use.
Register Password	Keep the default value.

3) Click **Save**.

Click  to modify room information, and click  to delete a room.

- Add room number in batches
- 1) Enter the total number of floors, total number of rooms on one floor, 1st room No. of the 1st floor, and 1st room No. of the 2nd floor as needed.
  - 2) Click **Add** at the bottom left of the interface.  
All the added room numbers are displayed. Click **Refresh** to view the latest status, and click **Clear** to delete all the room numbers.

## 4.4 Configuring Indoor Monitor

When the indoor monitor is used for the first time, you need to select a language that you prefer, initialize the indoor monitor to get a password to enter project setting interface and an email to reset

password. In addition, you need to configure parameters for all door stations (VTO) and indoor monitors that are found on the indoor monitor you are operating.

## 4.4.1 Initialization

### 4.4.1.1 Quick Configuration for VTH (For Villa)

**Step 1** Power on the device.

Figure 4-11 Select a language



**Step 2** Select a language that you prefer.

**Step 3** Tap **OK**.

Figure 4-12 Select apartment or villa

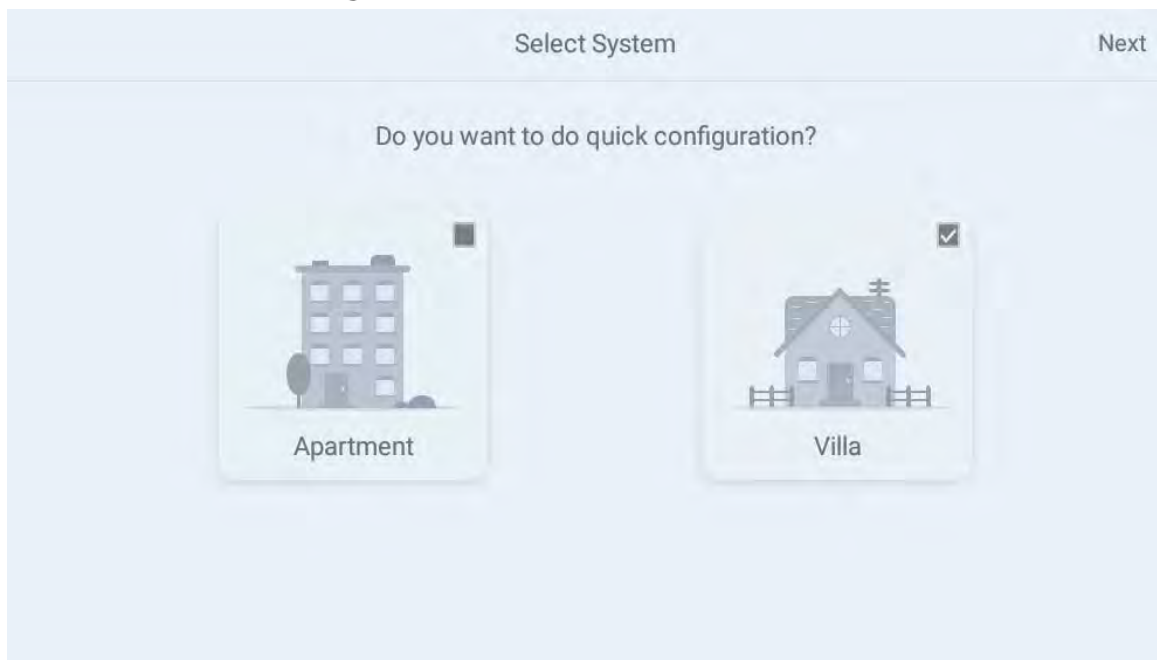

- Apartment: Select **Apartment** when the door stations and indoor monitors are installed in apartments. Quick configuration is not available when you select apartment.
- Villa: Select **Villa** when the door stations and indoor monitors are installed in villas. Quick configuration is available when you select villa.

**Step 4** Select **Villa**.

**Step 5** Tap **OK**.

Figure 4-13 Set local password

STEP1/3 Set Local password OK

Password 6 digits password

Confirm Pwd 6 digits password

Email This email is used to reset the password

**Step 6** Enter password, confirm password, and email for the VTH you are to initialize.

**Step 7** Tap **OK**.

Figure 4-14 Set another device password

STEP2/3 Set another device password Refresh Next

Device Type	SN	MAC	IP	Status	Operation
Local	[blurred]	[blurred]	[blurred]	Initialized	Initialize
VTO	[blurred]	[blurred]	[blurred]	Initialized	Initialize
VTO	[blurred]	[blurred]	[blurred]	Initialized	Initialize
VTO	[blurred]	[blurred]	[blurred]	Initialized	Initialize
VTO	[blurred]	[blurred]	[blurred]	Uninitialized	Initialize
VTH	[blurred]	[blurred]	[blurred]	Uninitialized	Initialize

**Step 8** Tap **Refresh**, and then tap **Next**.

Figure 4-15 Networking configuration

STEP3/3		Networking configuration			One-key Config	Quit
Device Type	SN	MAC	IP	Main/Sub	Results	Config
Local	XXXXXXXXXXXX	XXXXXXXXXXXX	192.168.1.160	Main	--	Edit
VTO	XXXXXXXXXXXX	XXXXXXXXXXXX	192.168.1.161	--	--	Edit
VTO	XXXXXXXXXXXX	XXXXXXXXXXXX	192.168.1.162	--	--	Edit
VTO	XXXXXXXXXXXX	XXXXXXXXXXXX	192.168.1.163	--	--	Edit

**Step 9** Tap **Edit** behind each device to do configurations.

- Configure indoor monitor (VTH).
- 1) Select an indoor monitor (VTH).

Figure 4-16 VTH config

Back	VTH Config	OK
Local IP		192.168.1.160
Netmask		255.255.255.0
Gateway		192.168.1.1

- 2) Enter local IP, Network, and gateway.
  - 3) Tap **OK**.  
The indoor monitor (VTH) configuration is completed.
- Configure Main VTO and Sub VTO. There must be only one main VTO and one or more sub VTOs.



If there are no sub door stations (VTO), then you do not need to do sub door station (VTO) configurations.

- 1) Select a door station (VTO).



Figure 4-17 VTO config (1)

The screenshot shows a configuration screen titled "VTO Config". At the top left is a "Back" button and at the top right is an "OK" button. The "Device Type" field has two radio buttons: "Main" (checked) and "Sub". Below this are input fields for "Local IP", "Netmask", and "Gateway". The "Date Format" is set to "DD-MM-YYYY" and the "Time Format" is set to "24-HOUR". The "Date" is set to "01-01-2000" and the "Time" is set to "00:00:00". The "Video Standard" field has two radio buttons: "PAL" (checked) and "NTSC".

Figure 4-18 VTO config (2)

The screenshot shows the same "VTO Config" screen. A red error message is displayed in the center: "Only one main VTO can exist in the system". In this configuration, the "Device Type" field has "Main" (unchecked) and "Sub" (checked) radio buttons selected. The other fields (Local IP, Netmask, Gateway, Date Format, Time Format, Date, Time, Video Standard) are visible but not fully legible.

- 2) Select **Main** or **Sub**.  
Enter local IP, Network, gateway; select video standard, date format, time format; set date and time.
- 3) Tap **OK**.
- 4) Tap One-key Config.  
The VTO configuration will be completed in a few seconds.

Figure 4-19 Making the configuration effective

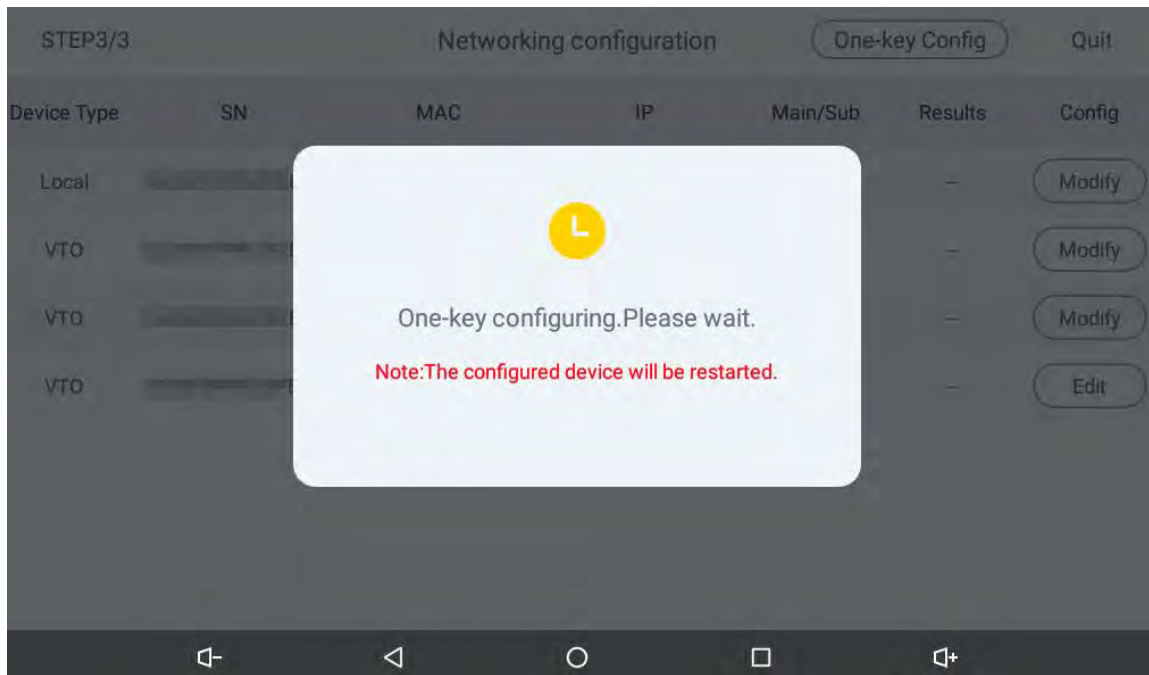

#### 4.4.1.2 Normal Configuration for VTH (For Apartment)

Step 1 Tap **Apartment** on Figure 4-12.

Step 2 Connect the indoor monitor to power source.

Step 3 Enter the password, confirm password, and email.



- Password: The password is used when administrators need to go to the project mode.
- Email: The email is used when you need to reset the password.

Step 4 Tap **OK**.

Figure 4-20 Main menu

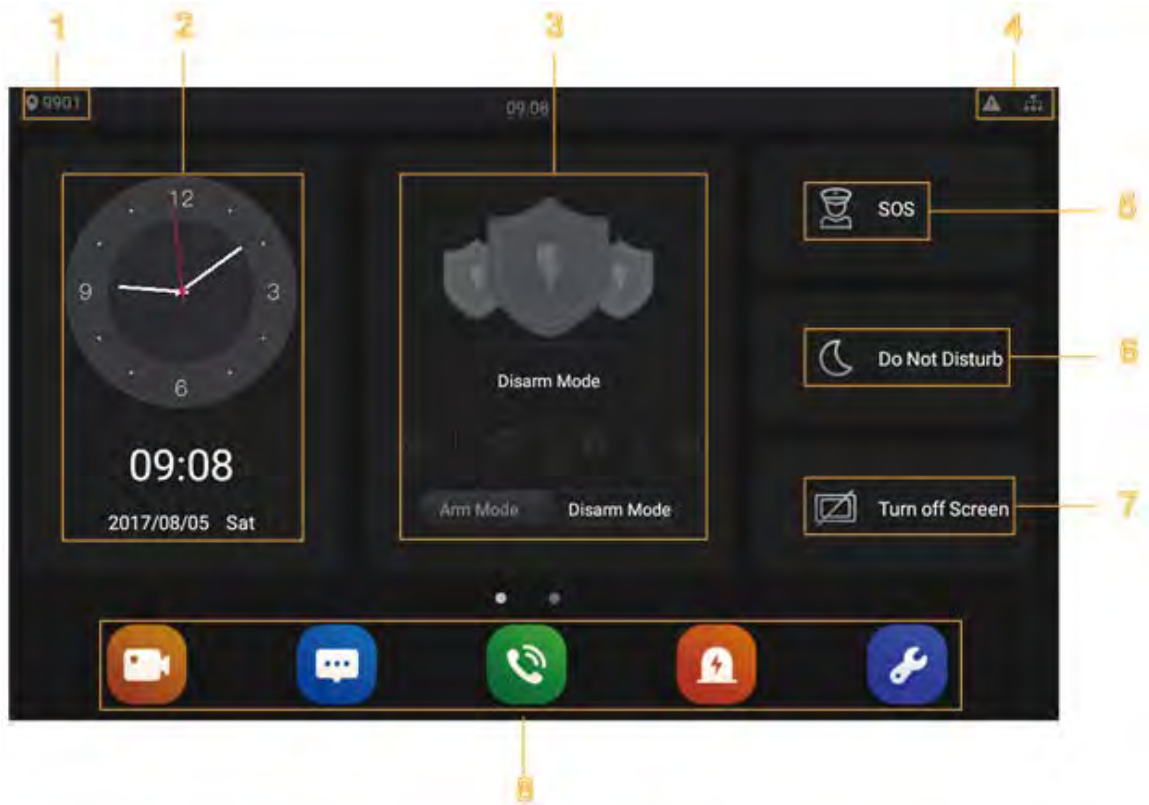

















Table 4-5 Description of main menu

No.	Name	Description
1	Room number	Number of the room where the indoor monitor is installed.
2	Date and time	Current time and date are displayed here.
3	Arm and disarm	Shortcut icons to arm or disarm are displayed here. The four icons represent at home mode, away from home mode, sleep mode, and customizable mode. Select <b>Arm Mode</b> or <b>Disarm Mode</b> first, and then tap the icons to arm or disarm.
4	Status bar	<ul style="list-style-type: none"> <li>● : The wired network is not connected.</li> <li>● : The wired network is connected.</li> <li>● : The indoor monitor failed to be connected to the SIP server. If this icon does not appear, then the indoor monitor is connected to the SIP server.</li> <li>● : The SD card is inserted and recognized.</li> <li>● : The indoor monitor is in the Do not disturb mode. It is disabled by default.</li> <li>● Door Status <ul style="list-style-type: none"> <li>◇ : Door closed.</li> <li>◇ : Door open.</li> <li>◇ : Unknown.</li> </ul> </li> </ul>

No.	Name	Description
5	SOS	Tap the SOS icon, the indoor monitor will call the management center.
6	Do not disturb	<p>Tap the icon, and then you can set do not disturb period. You need to enable DND Period first, and then you can do do-not-disturb settings.</p> <p>For details, see DND after tapping  and entering the password (123456 by default, and this password can be changed in 4.4.4.4 General).</p> <p></p> <p>It is recommended that the password be changed during the first use.</p>
7	Turn off screen	Tap the icon, and then the screen will be turned off.
8	Function buttons	<ul style="list-style-type: none"> <li>● : Tap the icon, and then you can watch videos from door stations and IP cameras.</li> <li>● : Tap the icon, and then text messages and videos left by visitors, or public notices released by the management center will be displayed.</li> <li>● : Tap the icon, and then you can make calls to other indoor monitors and the management center; and you can also view call logs and your contacts on this interface.</li> <li>● : Tap the icon, and then you can view alarm logs, do alarm settings for 6 areas as needed.</li> <li>● : Tap the icon, enter the password (123456 by default, and this password can be changed in 4.4.4.4 General), and then you can select ringtones for different door stations, Do Not Disturb period, call forward mode (there are three options: Always, Busy, and No Answer), and other settings.</li> <li>● Sound Recorder: You can record your voice messages to the SD card or to the indoor monitor.</li> <li>● Calculator: You can do calculations through the calculator.</li> <li>● Files: You can view files like images, videos, audio, and recently produced files.</li> <li>● Calendar: You can view date through the indoor monitor, and create notes, schedules, and plans.</li> <li>● Gallery: You can view images captured by door stations (VTO) or IP cameras.</li> </ul>

## 4.4.2 Network Settings

Connect the indoor monitor to the network, and then the indoor monitor can communicate with other devices.

## Wired Network

Make sure that IP address of the indoor monitor and IP address of door stations are in the same network segment; otherwise the indoor monitor cannot acquire door station information.

**Step 1** Tap the **Settings** icon.

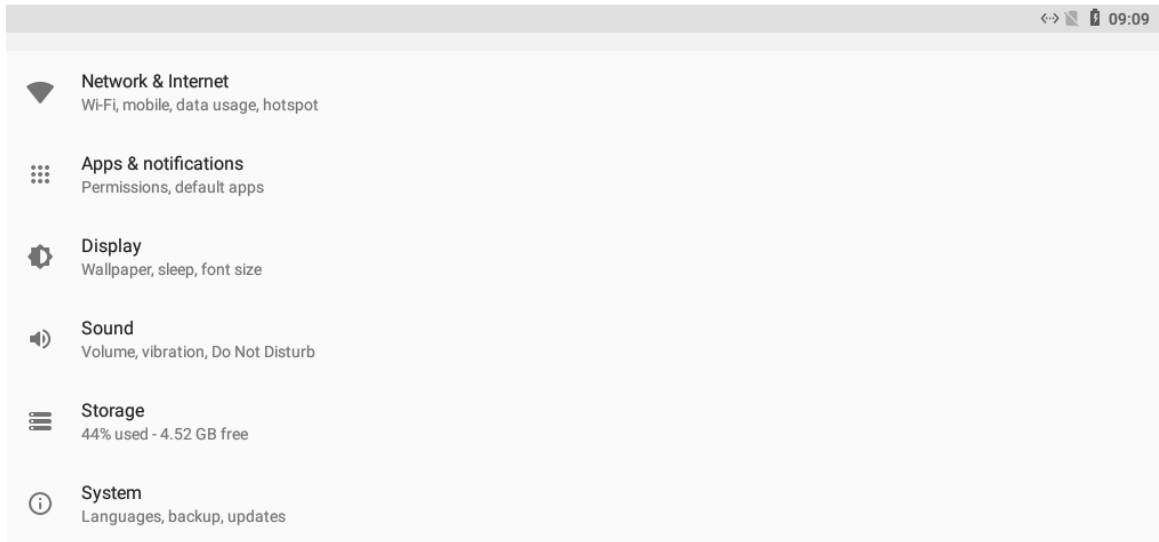

**Step 2** Enter the password (123456 by default, and this password can be changed in 4.4.4.4 General).

Figure 4-21 Network settings



**Step 3** Configure parameters.

Table 4-6 Parameter description

Parameter	Description	
Network & Internet	<p>You can choose to enable Wi-Fi or not by tapping .</p> <ul style="list-style-type: none"> <li>Tap , and then available Wi-Fi networks will be displayed.</li> <li>You can select Ethernet IP mode. There are two options: Static and DHCP.</li> </ul>	
Apps & notifications	<p>You can view the recently opened apps, apps opened by default, app permissions (apps using location, microphone, and camera), app notifications, and special app access.</p>	
Display	<p>You can adjust display brightness, display sleep duration, font size, and display size.</p>	
Sound	<p>You can adjust media volume and notification volume. You can also select to use default notification sound and default alarm sound.</p>	
Storage	<p>Spaces used and spaces left can be viewed. You can delete unwanted files as needed.</p>	
System	Languages & Input	<ul style="list-style-type: none"> <li>Languages: You can select languages as needed.</li> <li>Keyboard &amp; Inputs: There are two options: Virtual keyboard and physical keyboard.</li> <li>Input assistance: You can use spell checker, autofill service (not available at present), personal dictionary, and text-to-speech output as needed. Pointer speed can also be adjusted.</li> </ul>
	Backup	<p>You can use backup storage as needed.</p>

Parameter	Description	
	Reset options	You can reset Wi-Fi, mobile, and Bluetooth, and app preferences. You can also erase all data, which means restoring the indoor monitor to factory settings.
	About tablet	You can see details (battery status, network status, legal information, model, android version, Android security patch level, baseband version, Kernel version, build number, and more) about the indoor monitor.

**Step 4** Tap **Network & Internet**.

**Step 5** Tap **Ethernet**.

Figure 4-22 Network setting

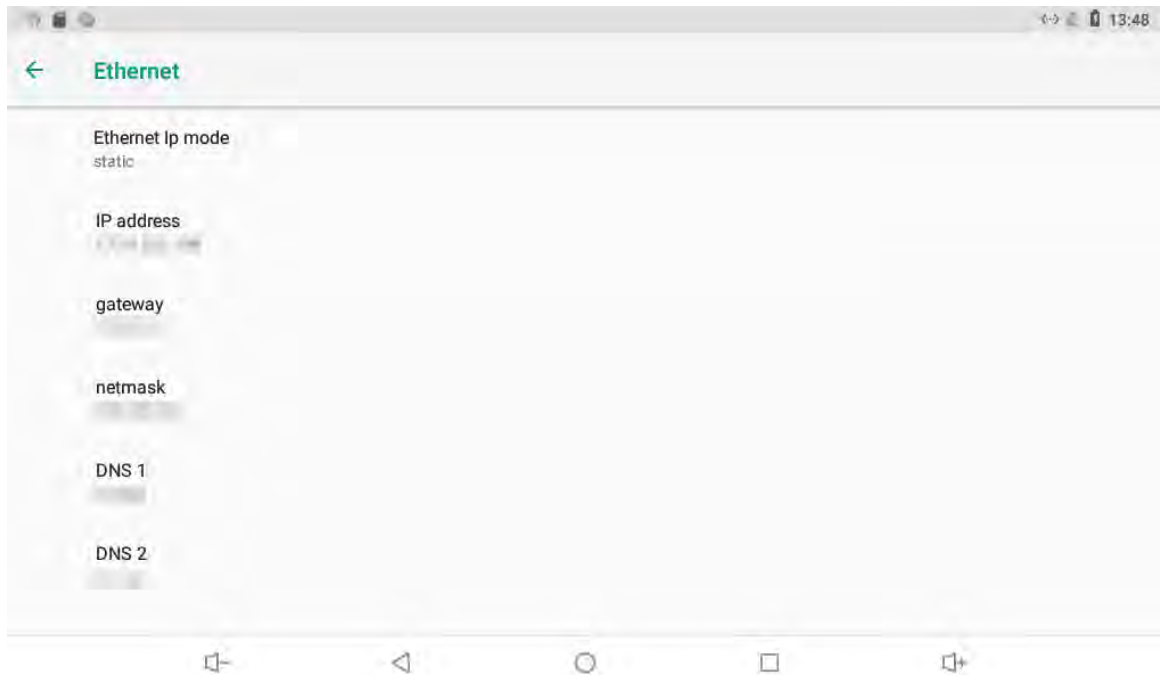

**Step 6** Tap Ethernet Ip mode.

- Select static: Enter IP address, gateway, netmask, and then tap **CONNECT**.
- Select dhcp: Tap dhcp, the IP information will be automatically acquired.

## Wireless Network

**Step 1** Tap the **Settings** icon.

**Step 2** Tap Network & Internet.

**Step 3** Tap , the Wi-Fi is enabled.

**Step 4** Tap , the available wireless networks are displayed.

Figure 4-23 Wi-Fi



- Step 5** Select a wireless network.
  - Step 6** Enter the password.
  - Step 7** Tap **CONNECT**.
- The network is connected.

### 4.4.3 Project Settings

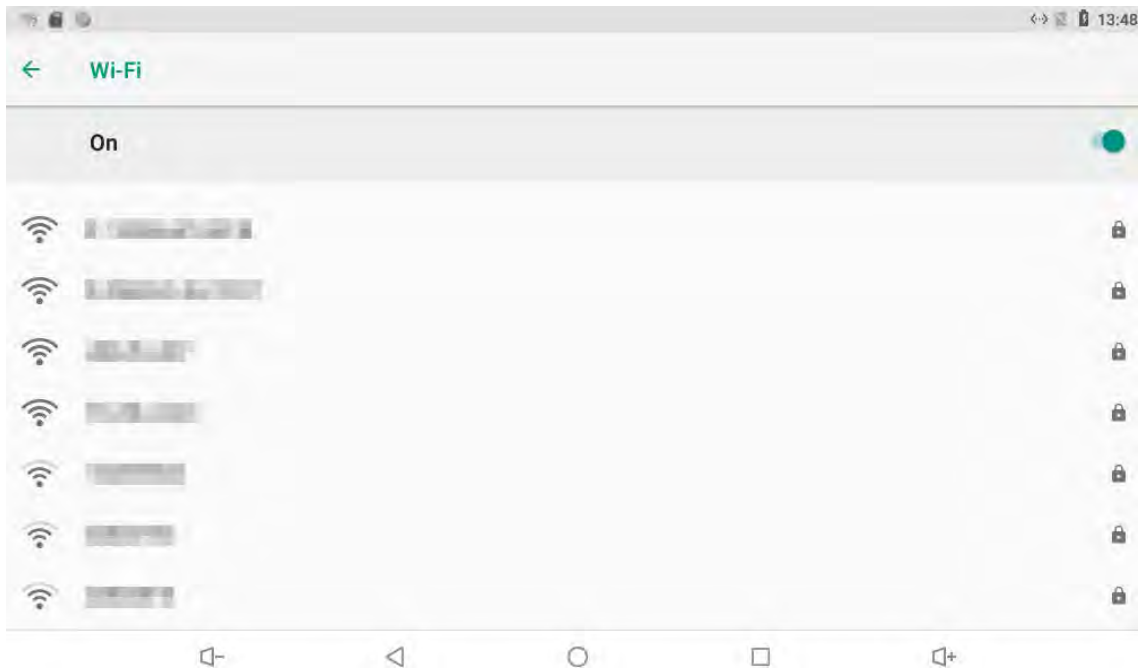
Tap and hold , enter the password (the password set during initialization), and then the **Project Settings** interface will be displayed.

Figure 4-24 Project settings



### 4.4.3.1 VTH Config

- Room No.: Number of the room where the indoor monitor is installed.
- Device Type: There are two options: **Master** and **Extension**.
  - ◇ Master: If the indoor monitor that you are operating works as the master station, you need to select **Master**.
  - ◇ Extension: If the indoor monitor works as an extension, you need to select Extension.
- Master IP: When the indoor monitor works as an extension, you need to enter IP address of the master station.
- Master Name: Keep the default value.
- Master Pwd: The password you set during initialization (6 characters).
- System Version: You can view system version of the indoor monitor.
- Security Baseline Version: You can view security baseline version of the indoor monitor.

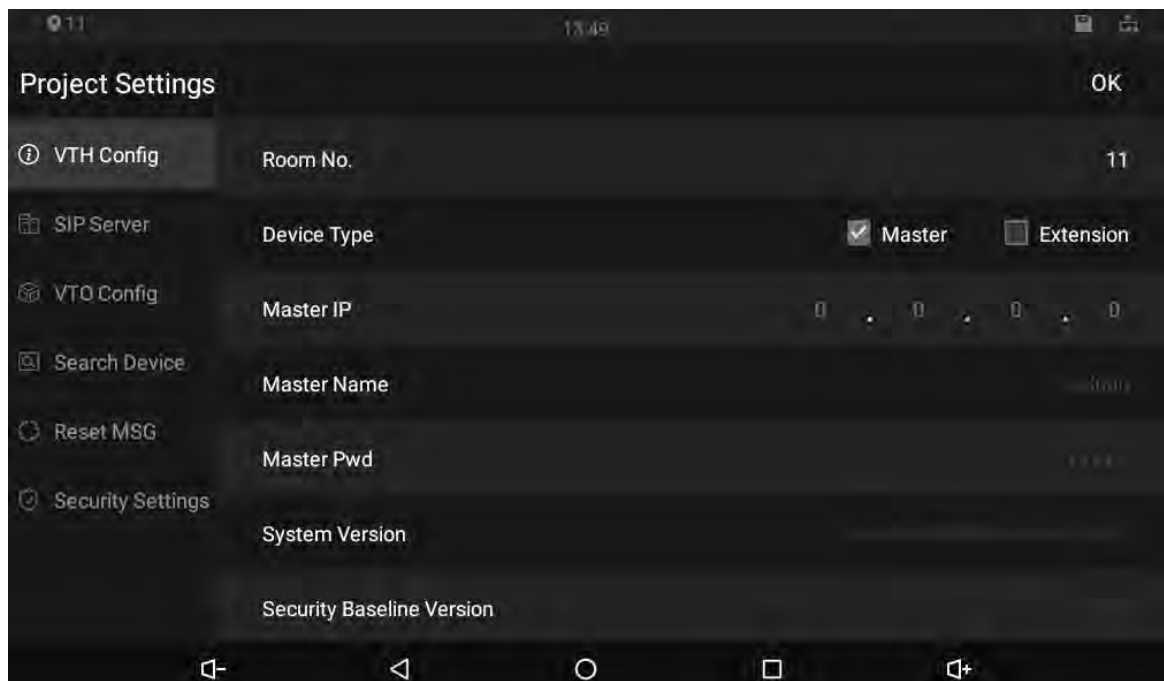
### 4.4.3.2 SIP Server

You need to enter SIP server information, and then video door phones in the same system can communicate with each other.

Tap **SIP Server**.

Figure 4-25 SIP server (1)

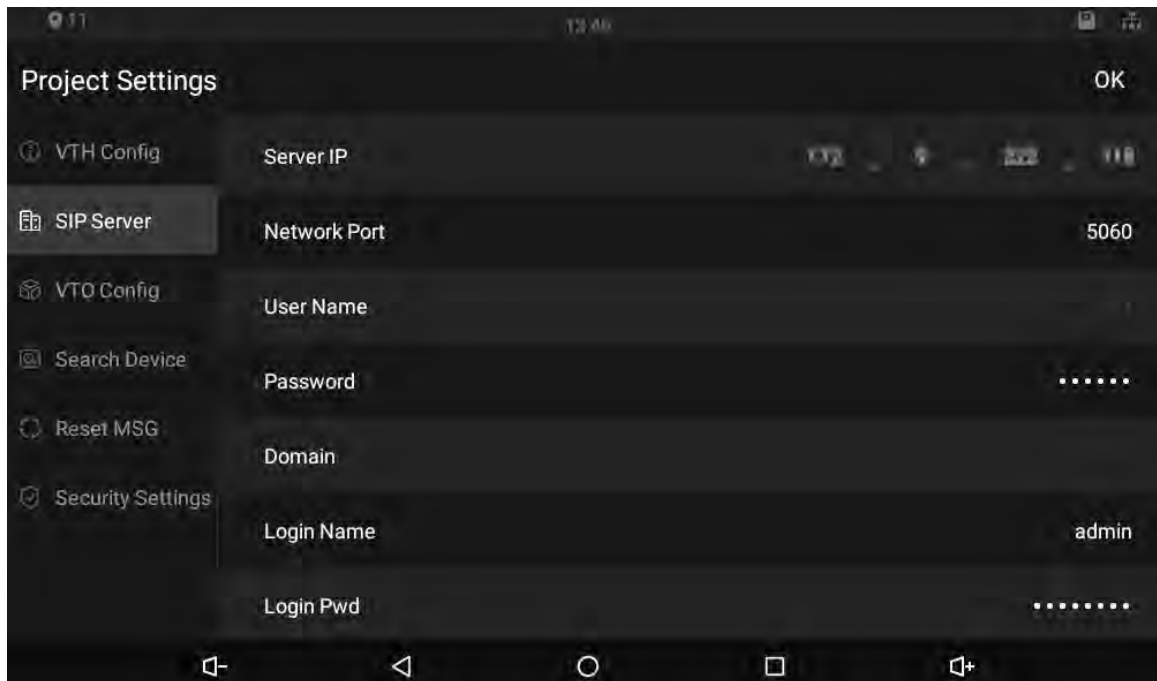

Table 4-7 SIP server description

Parameter	Description
Server IP	<ul style="list-style-type: none"> <li>● When the platform works as SIP server, server IP is IP address of the management platform.</li> <li>● When a door station works as SIP server, server IP is IP address of the door station.</li> </ul>
Network Port	<ul style="list-style-type: none"> <li>● When the platform works as SIP server, network port is 5080.</li> <li>● When VTO works as SIP server, network port is 5060.</li> </ul>



Parameter	Description
User Name	Keep default value.
Password	
Domain	Registration domain of SIP server, which can be null. When VTO works as SIP server, registration domain of SIP server shall be VDP.
Login Name	Username and password to log in to web of the SIP server.
Login Pwd	
Status	Enable the SIP server status, and then the SIP server can start to work.

### 4.4.3.3 VTO Config

You need to add door stations to the indoor monitor, and then calls can be made among door stations and indoor monitors.

**Step 1** Tap **VTO Config**,

Figure 4-26 Door station (VTO) configuration

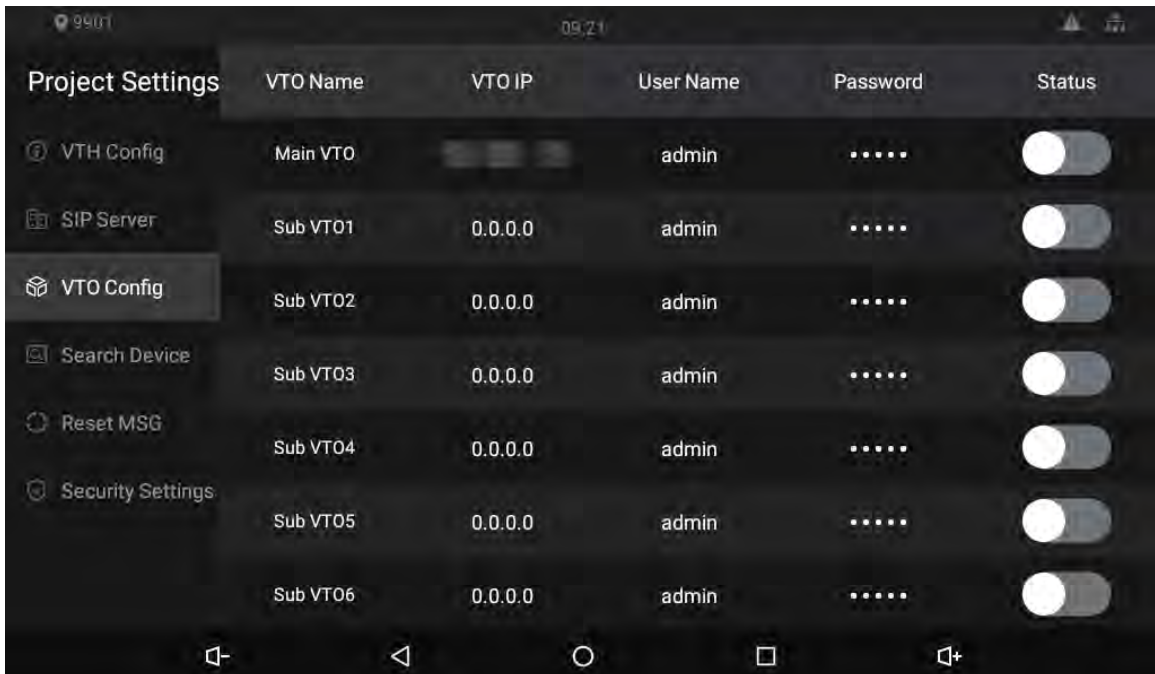

**Step 2** Tap a door station (VTO).

Figure 4-27 VTO IP

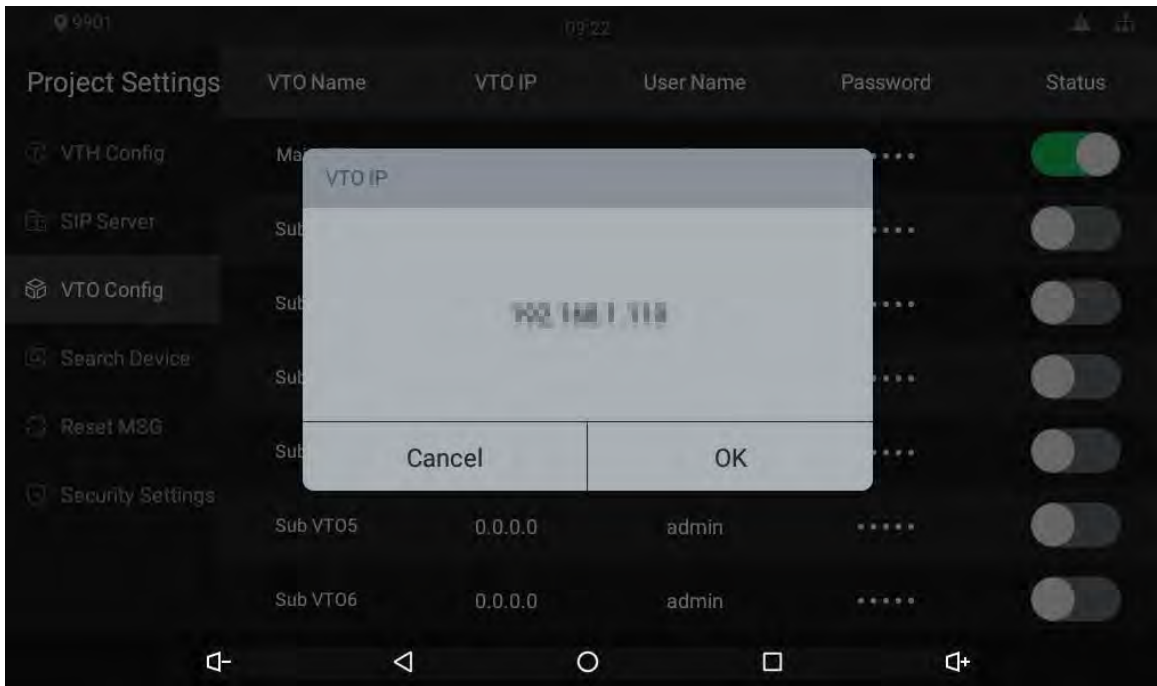

**Step 3** Tap the default IP, and then the on-screen keyboard appears.

**Step 4** Enter the door station (VTO) IP, user name, and password (used to log in to the door station web interface).



- You can add 20 door stations (one main door station and 19 sub door stations) to the indoor monitor.
- Make sure that user name and password that you entered here are the same as the user name and password used when logging in to the door station web interface.

**Step 5** Tap  to enable the door station.

#### 4.4.3.4 Searching Device

Tap the **Search Device** icon, and then the system starts to search devices automatically. You can add the device found to the indoor monitor.

Figure 4-28 Searching device (1)

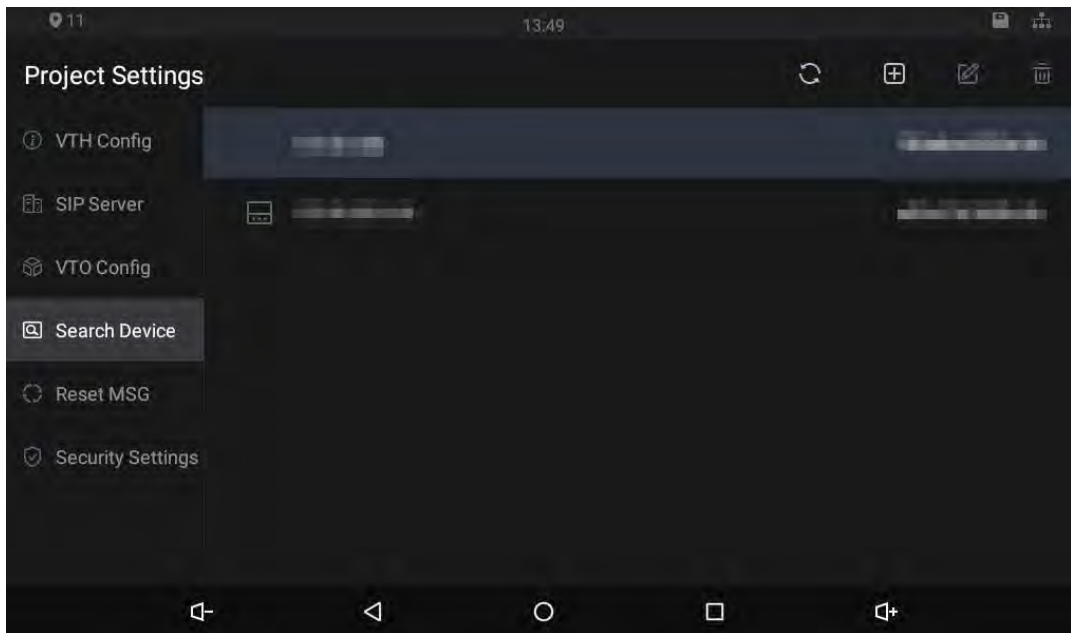
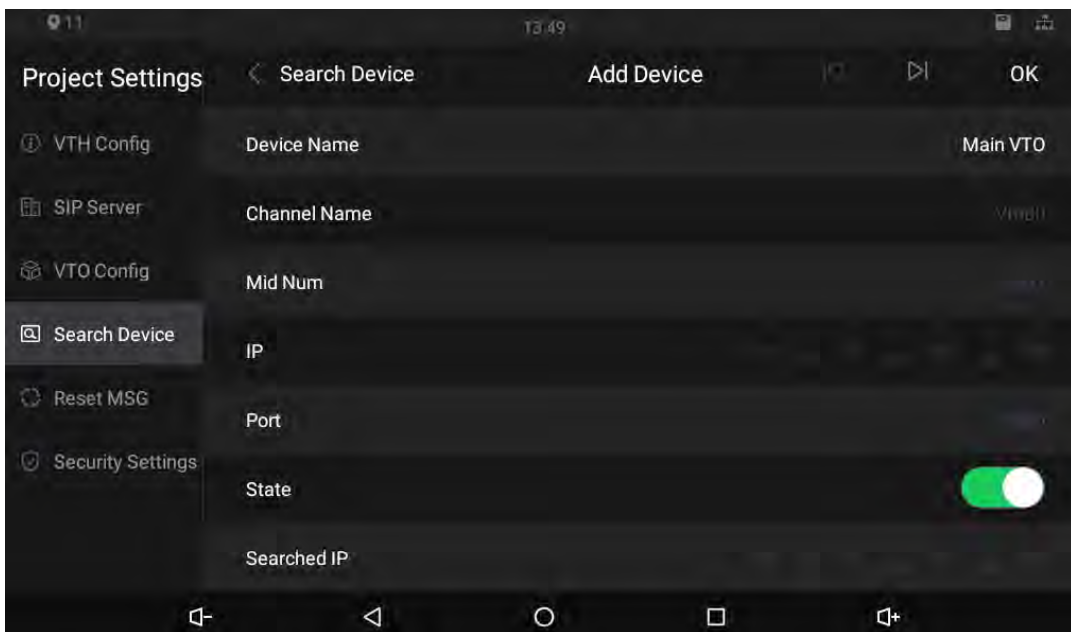

Figure 4-29 Searching device (2)



#### 4.4.3.5 Resetting Password

You can change the email address that you use to reset your password.



You need to enable the **Resst Password** first if you want to reset the password.

**Step 1** Tap and hold .

**Step 2** Tap **Forgot password?**.

**Step 3** Tap **OK**.

**Step 4** Scan the QR code with any app with scanning function.

- Step 5** Send the string to the email address displayed on your device interface with the email address you set on the **Reset MSG** interface.  
A safe number will be sent to your email address.
- Step 6** Tap **Next** and then enter the new password, confirm password, and safe number.  
The password is reset.

Figure 4-30 Reset password

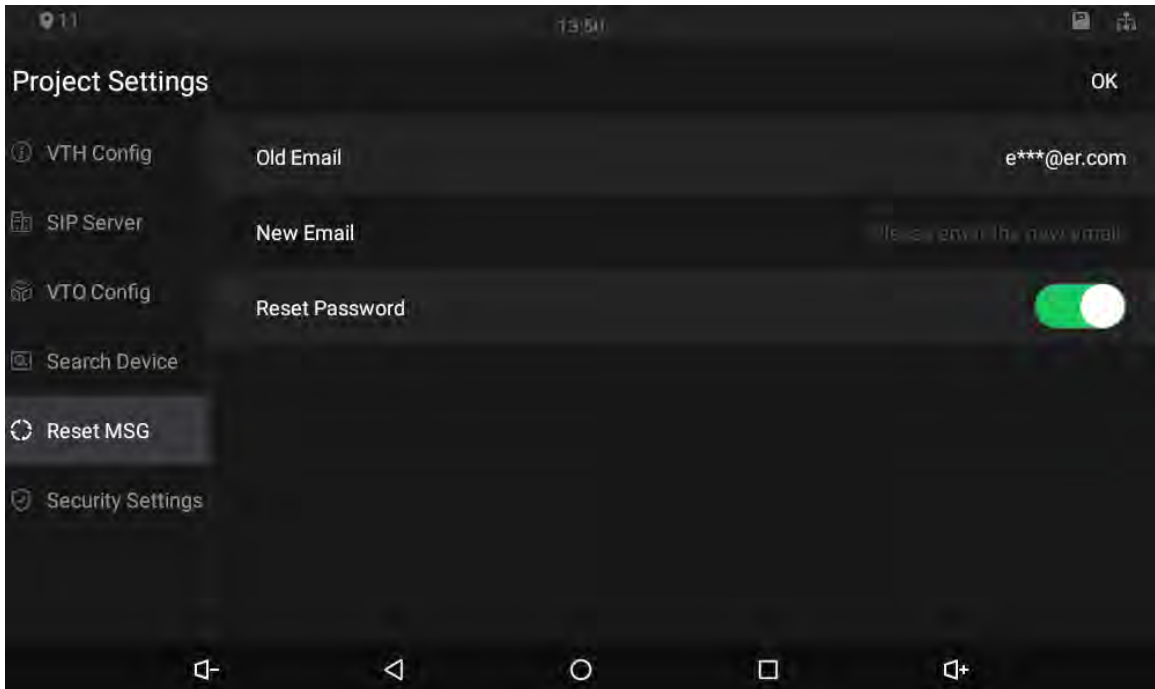

### 4.4.3.6 Security Settings

You need to enable the trusted list, and then trusted devices can communicate with the indoor monitor. You can also use Dshell to get the ability to develop custom analysis modules which help you understand events of cyber intrusion.

Figure 4-31 Enable trusted list

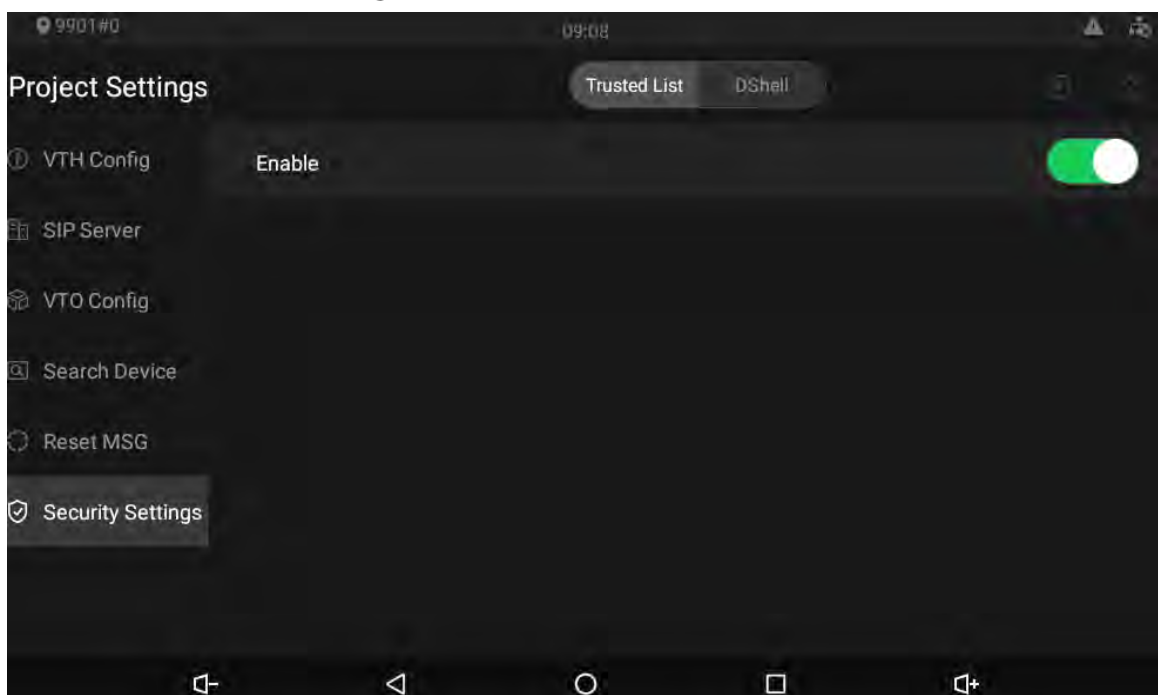
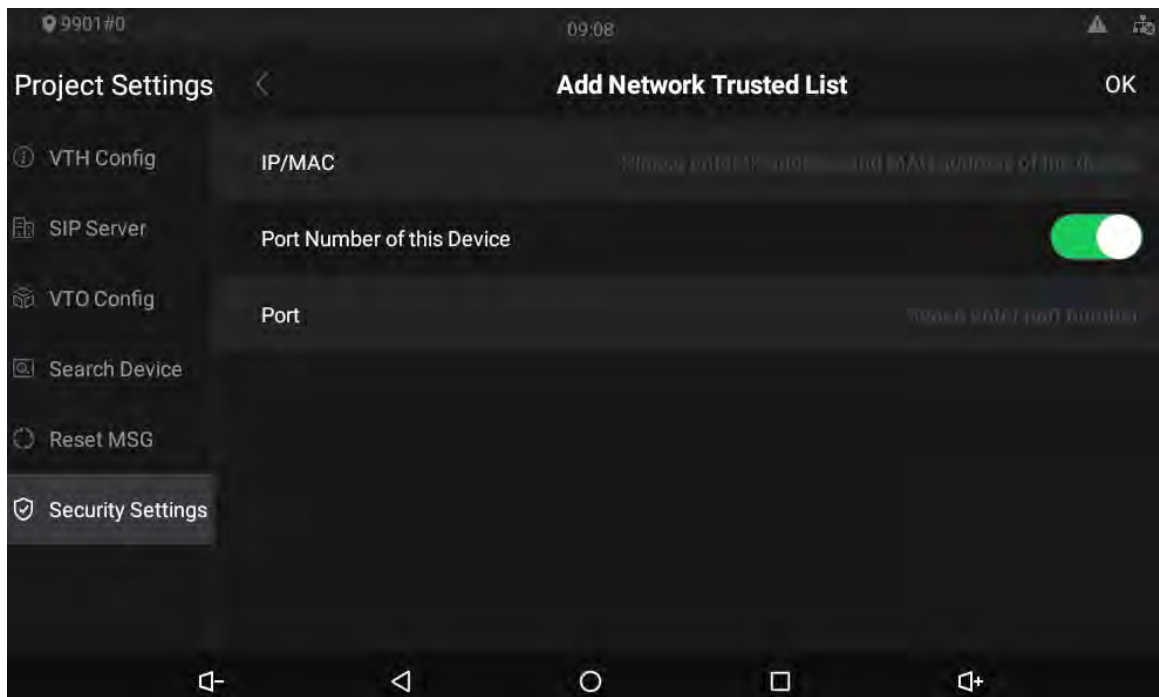



Figure 4-32 Add network trusted list



You need to tap  on the enable trusted list interface, and then the **Add Network Trusted List** will be displayed.

## 4.4.4 General Settings

Tap , enter the password (123456 by default, and this password can be changed in 4.4.4.4 General). You can select ringtones for different door stations, Do Not Disturb period, call forward mode (there are three options: Always, Busy, and No Answer), and other settings.

### 4.4.4.1 Ring

On this interface, you can select ringtones for different door stations, indoor monitors, and alarm devices.

Figure 4-33 Ring

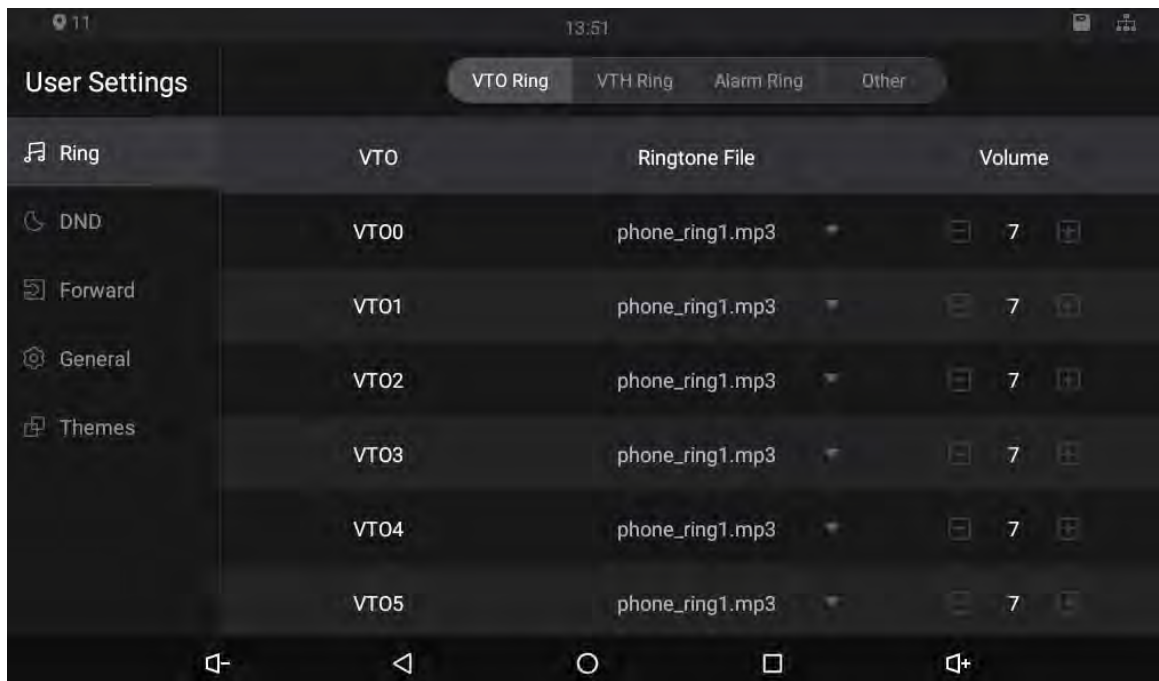

#### 4.4.4.2 DND

Enable **DND Period** first, and then you can set do not disturb period for each day.

Figure 4-34 DND

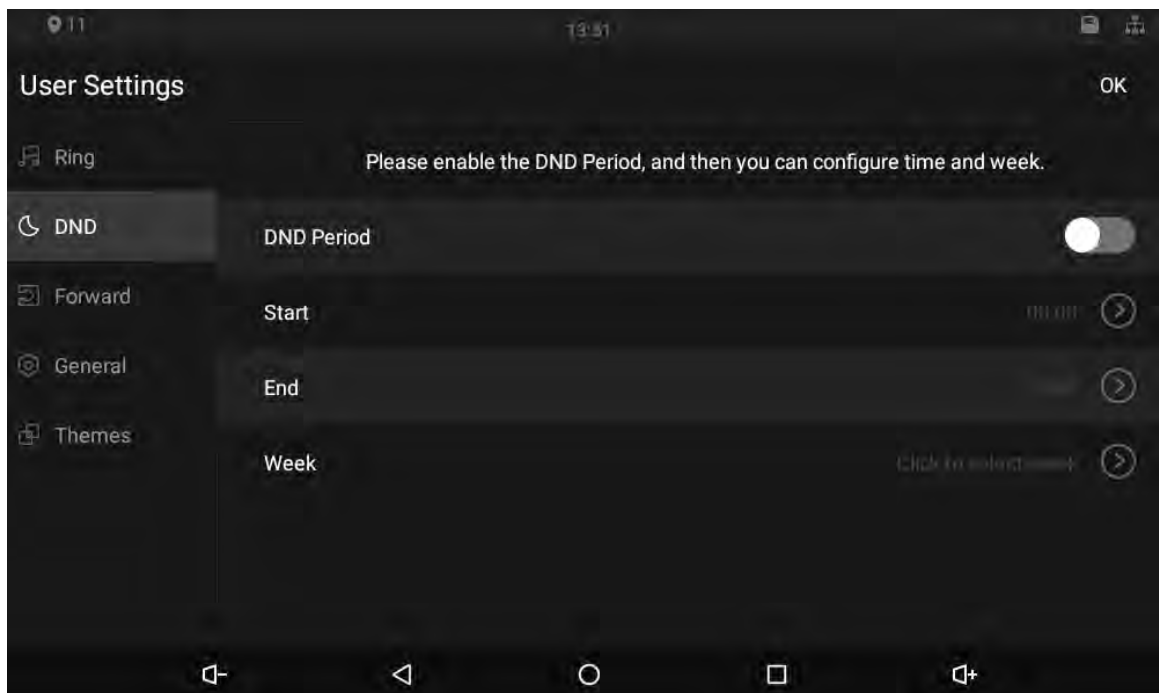

#### 4.4.4.3 Forward

When calls come in, they will be forwarded to the numbers you have set in advance. There are three options: **Always**, **Busy**, and **No Answer**.

Figure 4-35 Forward

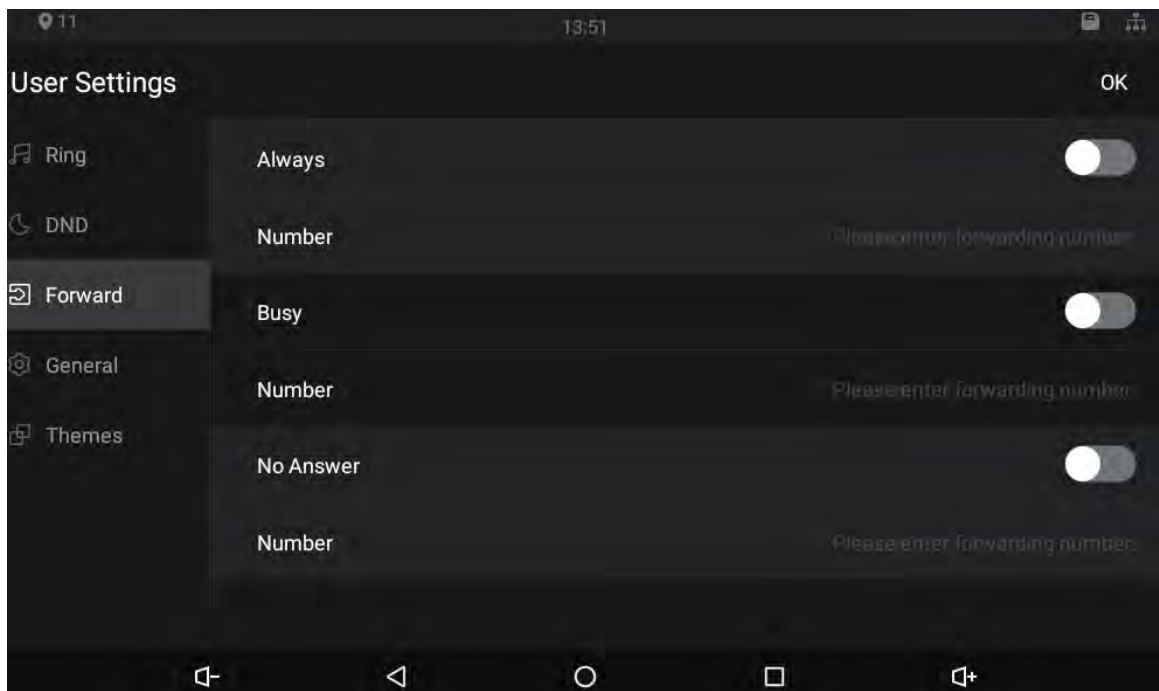

- Always: Whenever calls come in, they will always be forwarded.
- Busy: If calls come in when you are talking to others over the indoor monitor, the calls will be forwarded.
- No Answer: When the coming calls are not answered, they will be forwarded.
- If you want to forward the call to residents in other apartment, you need to enter 0101101 for building 1 + apartment 1 + room 101.
- If you want to forward the call to residents in your apartment, enter the number of the room where the indoor monitor is installed.

#### 4.4.4.4 General

On the **General** interface, you can set new passwords for arming and disarming, registering new users and downloading apps by scanning QR codes, and setting other parameters.

Figure 4-36 Password

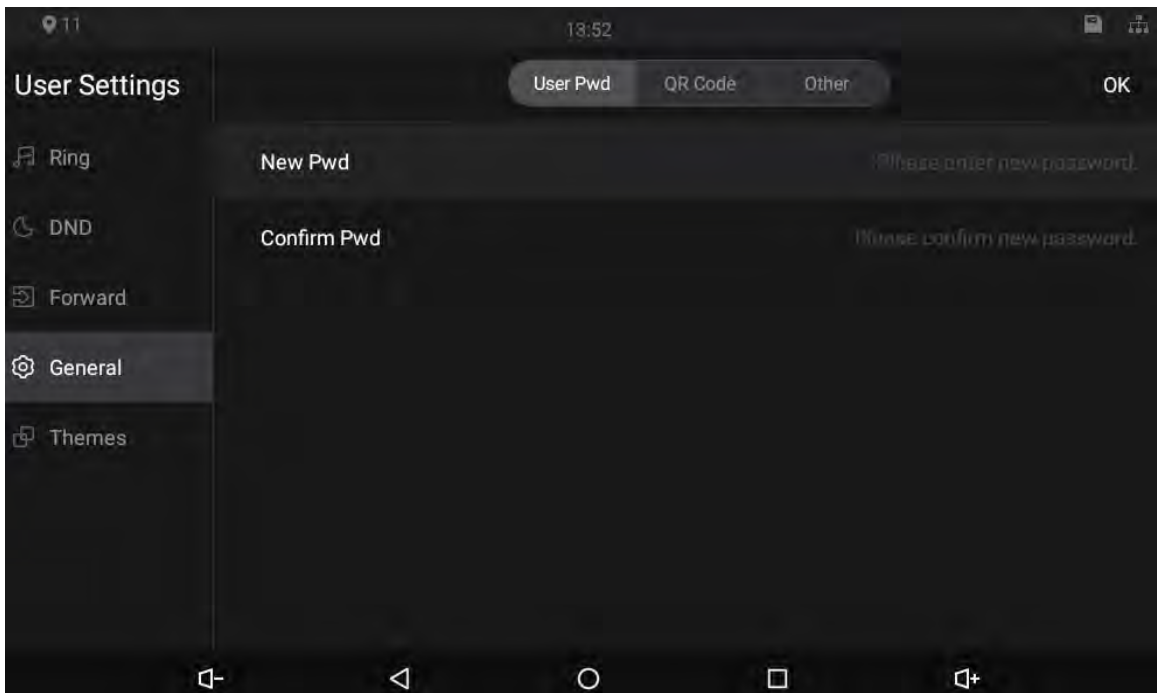
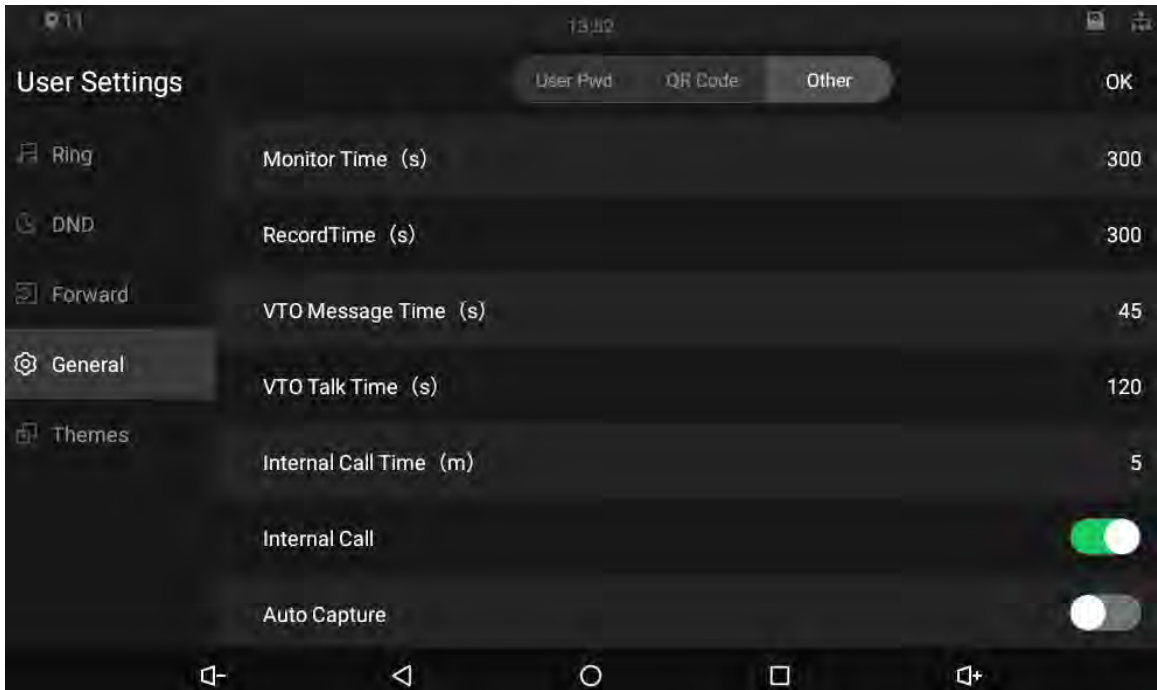

Figure 4-37 QR code





Figure 4-38 Other



- Monitor Time (s): You can watch monitoring images from the indoor monitor for at most 300 seconds a time.
- Record Time (s): You can record at most 300-second audio files a time on the indoor monitor.
- VTO Message Time (s): Visitors can only leave an at most 90-second message a time on the door station (VTO).
- VTO Talk Time (s): Visitors can talk to you through the door station (VTO) for at most 300 seconds a time.
- Internal Call Time (s): You can talk to other indoor monitors for at most 60 minutes a time.
- Internal Call: After the **Internal Call** is enabled, you can call other indoor monitors from the indoor monitor you are operating.
- Auto Capture: After the **Auto Capture** function is enabled, if a visitor called you but you did not answer the call, the door station (VTO) would take three images of the visitor standing in front of the door station. This function is available when SD card is inserted into the indoor monitor.

#### 4.4.4.5 Themes

You can select a theme for your indoor monitor. There are two options: **White Mode** and **Black Mode**.

Figure 4-39 Themes

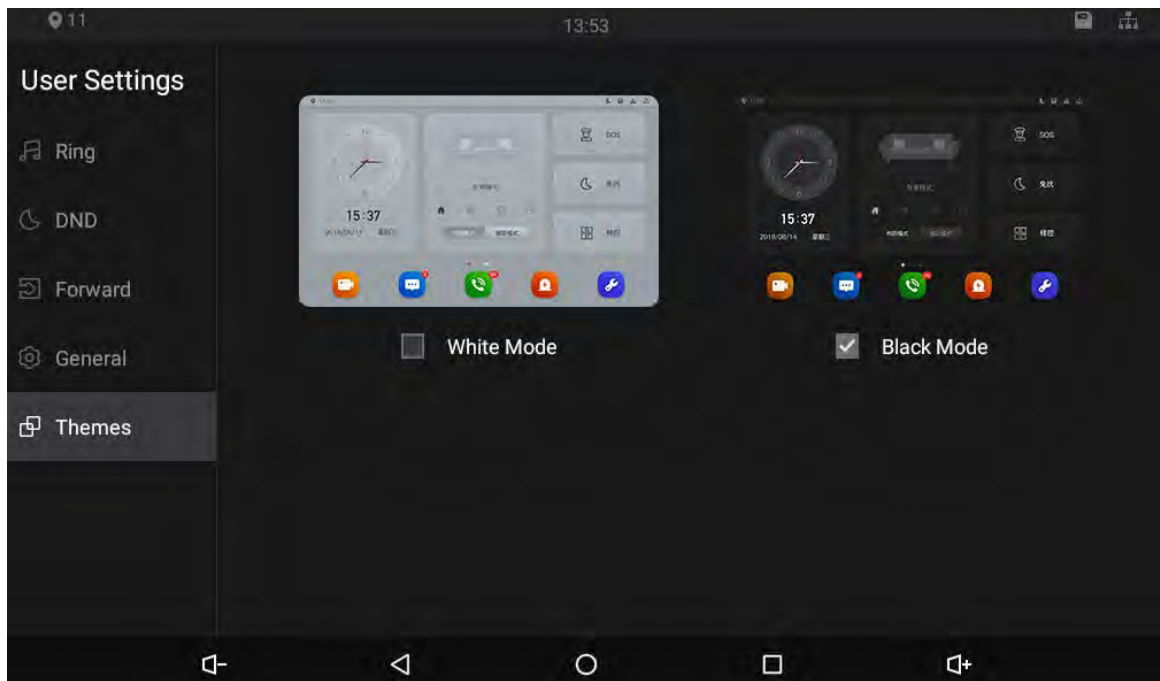

## 4.5 Alarm

### 4.5.1 Alarm Record

Tap . Peripheral alarm modules can be connected to the indoor monitor. You can view alarm logs, do alarm settings for 8 areas as needed. There are 7 types of alarms: Infrared, gas sensor, smoke sensor, urgency button, door sensor, stolen, perimeter, and doorbell.



Select Disarm on the main menu, and then you can do alarm settings.

Figure 4-40 Viewing alarm prompt

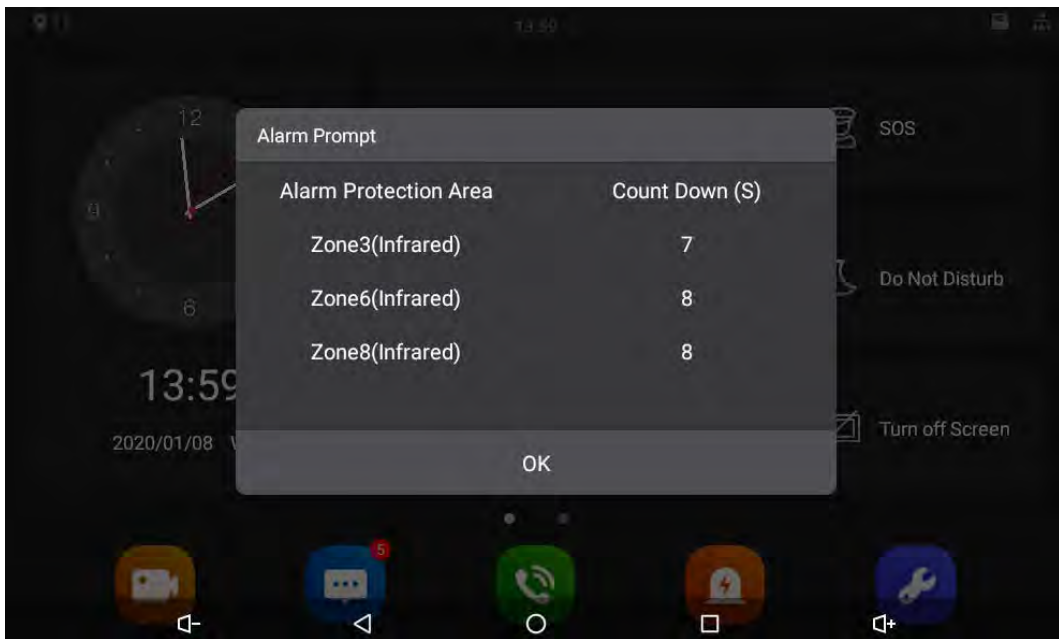
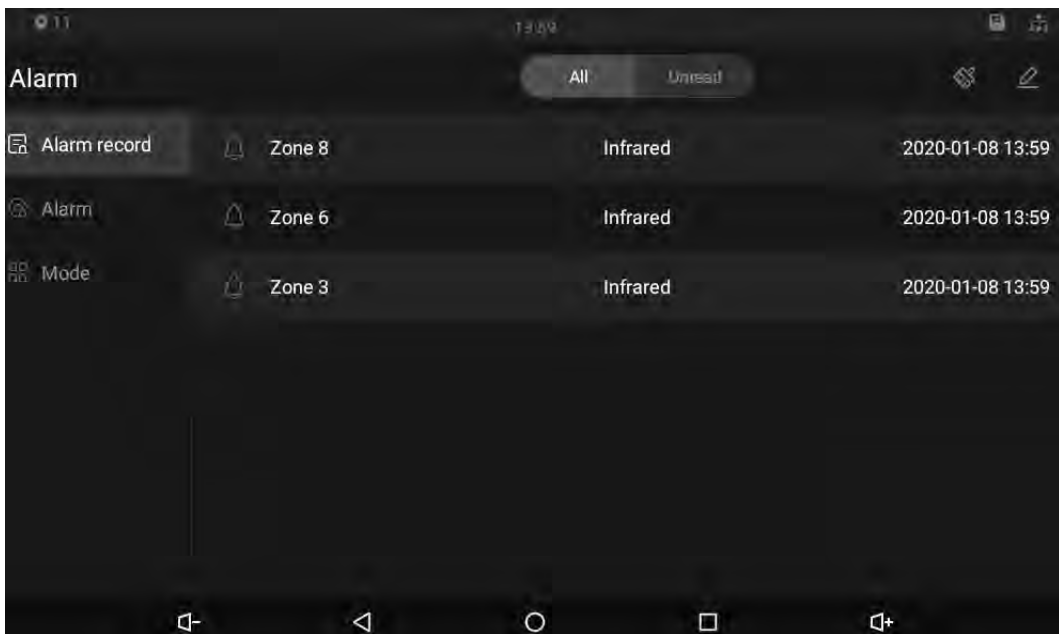

Figure 4-41 Viewing alarm record



## 4.5.2 Alarm Settings

### 4.5.2.1 Wire Zone

Set alarm settings for eight areas, and then if emergencies happen, alarms will be triggered.

Tap .

Figure 4-42 Wire zone

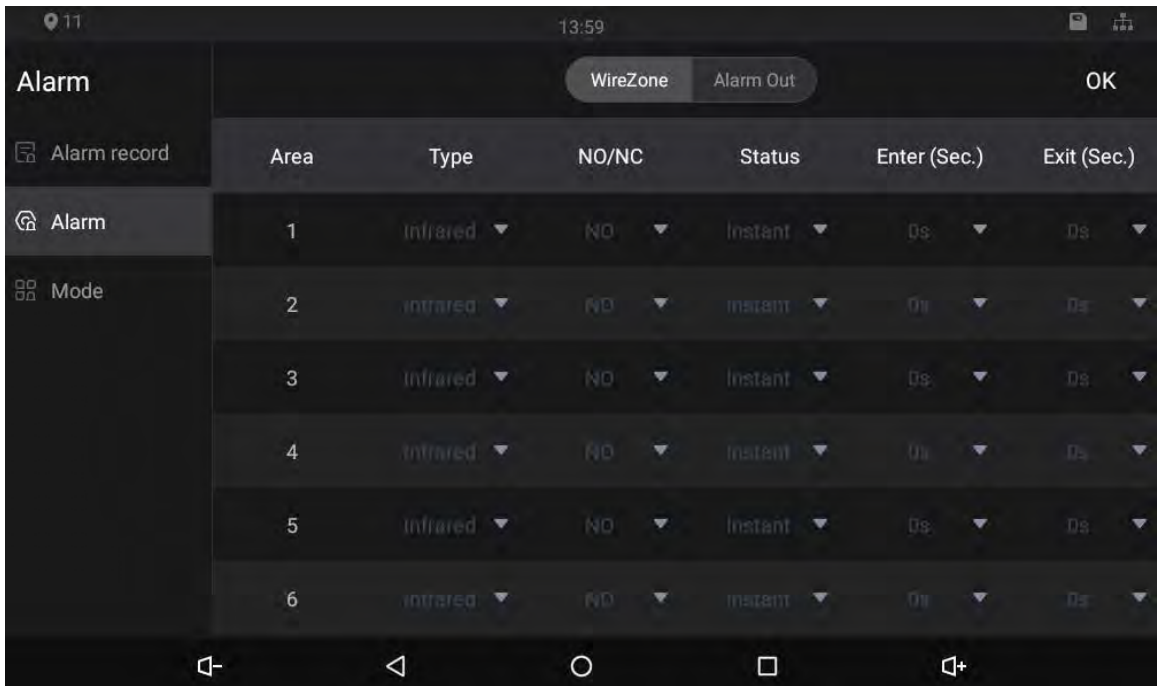



Table 4-8 SIP server description

Parameter	Description
Area	Area numbers. There are 8 areas in total. They cannot be modified.
Type	There are 8 types of alarms: Infrared, gas sensor, smoke sensor, urgency button, door sensor, stolen, perimeter, and doorbell. Select alarm types according to detector types.
NO/NC	Select NO (normally open) or NC (normally closed) according to detector types. It shall be the same as detector type.
Status	<p>There are 5 statuses: Instant, delay, bypass, remote, and 24-hour protection zone.</p> <ul style="list-style-type: none"> <li>Instant: In Arm Mode, if you selected this status for an area, once alarms are triggered, the indoor monitor will give out voice prompt immediately.</li> <li>Delay: In Arm Mode, if you selected this status for an area, once alarms are triggered, the indoor monitor will give out voice prompt a period later.</li> <li>Bypass: If you selected the bypass status for an area, after the area has been armed and alarms are triggered; there will be no voice prompt. Once the area is disarmed, alarm status will be back to normal.</li> <li>Remove: When you select <b>Arm Mode</b> and <b>Disarm Mode</b> for an area in "at home mode", "away from home mode", "sleep mode", and "customizable mode", the status of this area will not be changed.</li> <li>24-hour protection zone: If you selected this status for an area, no matter Arm on the main menu is selected or not, whenever alarms are triggered, voice prompt will always be given out.</li> </ul>
Enter (Sec.)	In the Arm Mode, after you have selected this status for an area, there will be no voice prompt when you enter the area from a disarmed area within the period you set; after that period has passed in the Arm Mode, voice prompt will be given out.

Parameter	Description
	 <p>This function is only available when you have selected Delay status for an area.</p>
Exit (Sec.)	<p>In the Arm Mode, after you have selected this status for an area, there will be no voice prompt unit you have exit the area within the period you set. After that period has passed in the Arm Mode, voice prompt will be given out when alarms are triggered.</p>  <ul style="list-style-type: none"> <li>• This function is only available when you have selected Delay status for an area.</li> <li>• If you have selected this status for more than one area, and then prompts of the area with the longest period will be displayed on the indoor monitor.</li> </ul>

### 4.5.2.2 Enable 433



This function is only available for models ending with A.

Only after you have enabled 433, the **Wireless Zone** interface will appear.

Figure 4-43 Enable 433

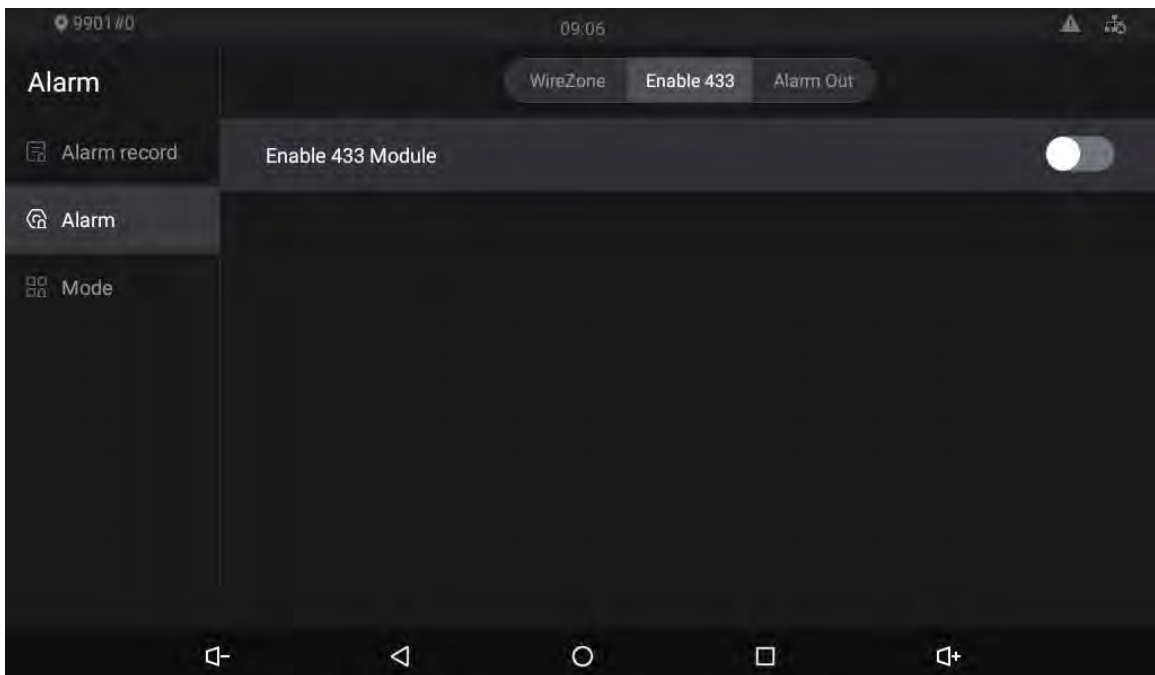

### 4.5.2.3 Wireless Zone

On the **WirelessZone** interface, you can add alarm devices for alarm areas, and then if alarms are triggered, alarm messages will be pushed to the indoor monitor.

**Step 1** Tap  on the main menu.

**Step 2** Select **Enable 433**.

**Step 3** Enable **433**.

**Step 4** Tap **WirelessZone**.

**Step 5** Tap **Add**.

The indoor monitor enters the pairing mode.

**Step 6** Press the pairing button on the alarm device.



Tap the device added, slide to the left, and then the delete button will appear. Tap deleting button to delete the device that you selected.

**Step 7** Tap **OK**.

Figure 4-44 Wireless zone

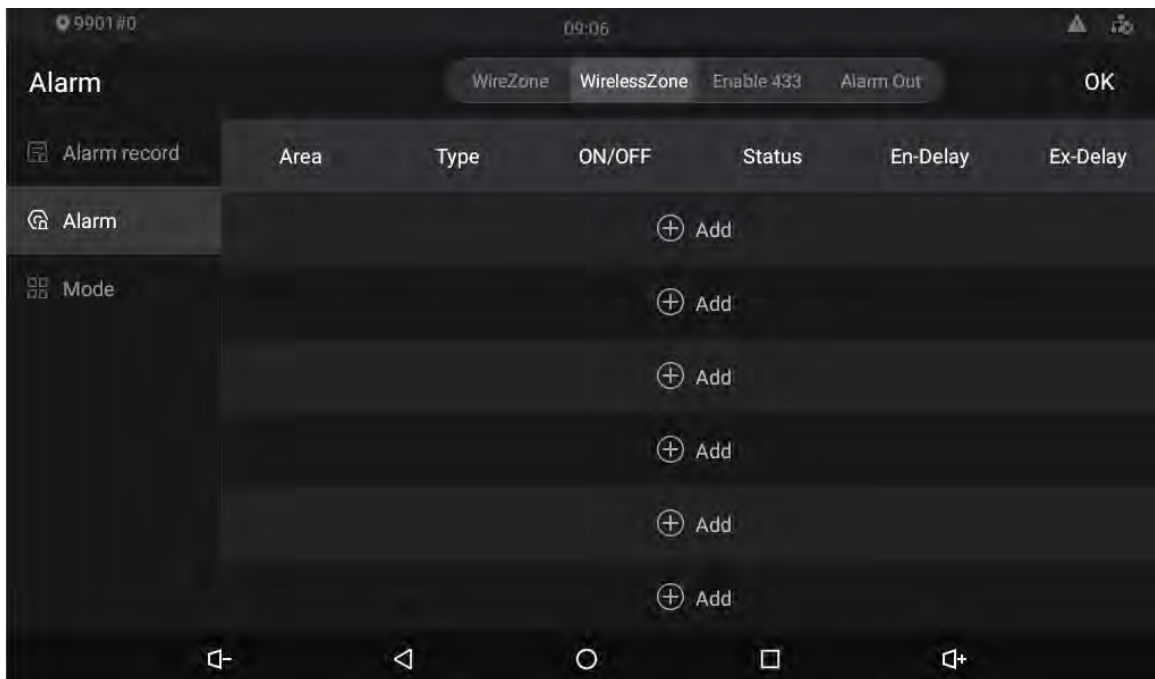

#### 4.5.2.4 Alarm Out

After you have enabled the alarm output function, when there are people making calls to the indoor monitor from other devices, alarm devices will send alarms.

Figure 4-45 Alarm out

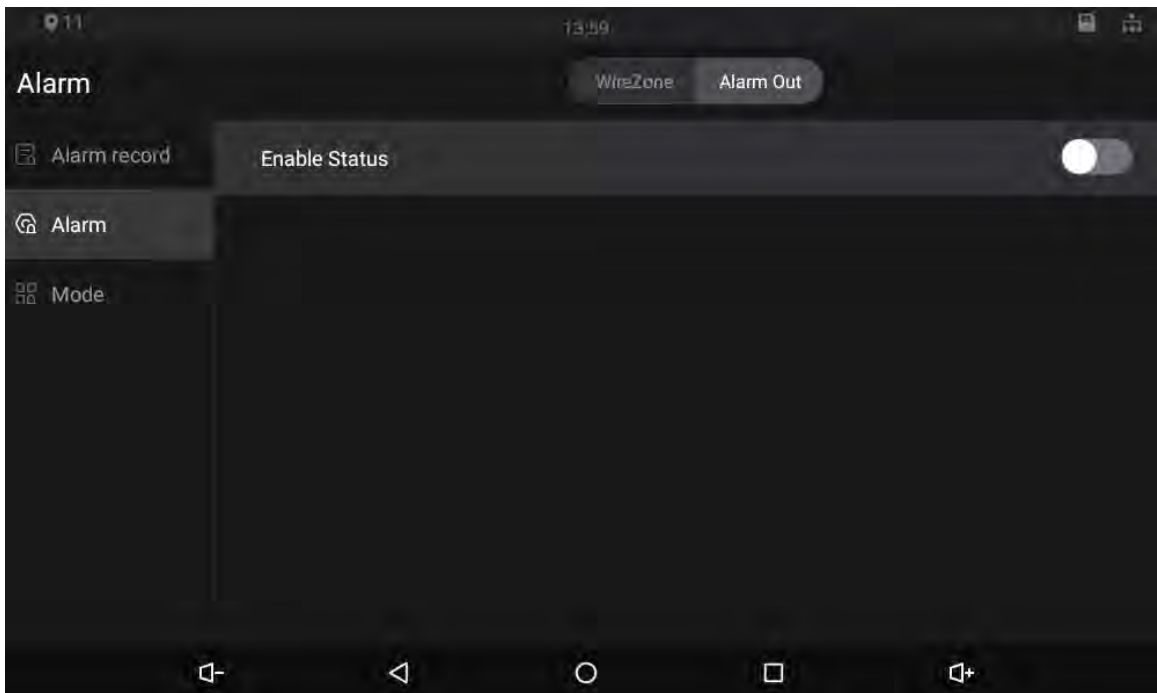

### 4.5.3 Alarm Mode

There are four modes: Home, away, sleep, and custom. Select modes as needed.



Only in the **Disarm Mode** can you enable alarm modes for the areas.

Figure 4-46 Alarm mode

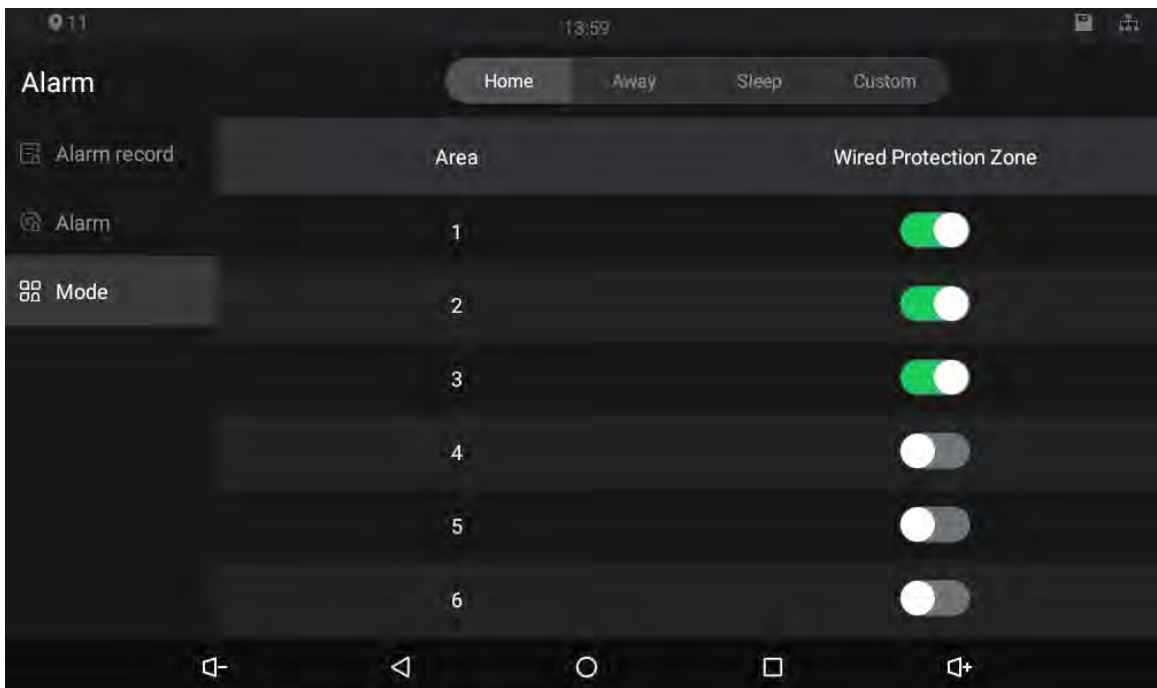

## 4.6 Unlocking

You can unlock doors connected to the door stations through the indoor monitor when watching monitoring videos, when someone is calling you from the door station, or when talking to the people at the door station over the indoor monitor.

## 4.7 Arm/Disarm

After areas are armed, when alarms are triggered, alarm messages will be pushed to the indoor monitor.



- Make sure that areas you want to arm are armed; otherwise alarms will not be triggered.
- Make sure that the area is in the disarmed status; otherwise you cannot arm the area. When **Disarm Mode** on the interface is white, it means that the indoor monitor is in the disarm mode.

### 4.7.1 Arm

Step 1 Tap **Arm Mode** on the main menu.

Figure 4-47 Arm

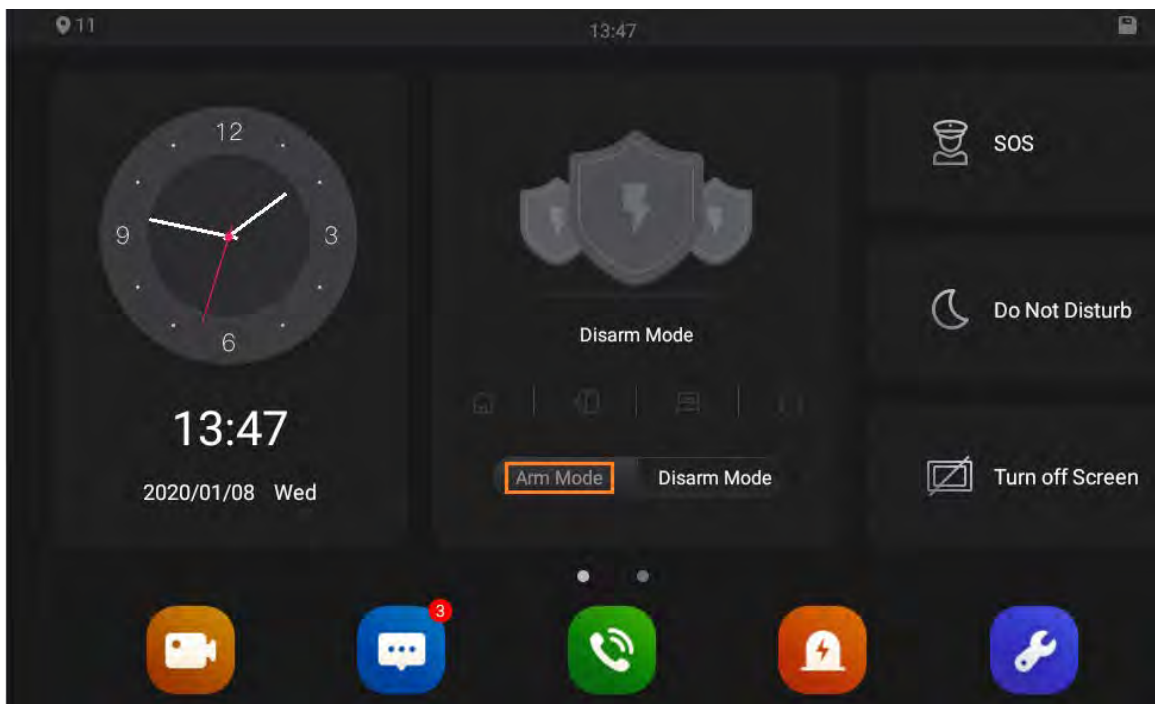

Step 2 Select an arm mode.



There are four modes: Home, Away, Sleep, and Custom. Select as needed.

Step 3 Enter the arm/disarm password, and tap **OK**.

You will hear beeps. It means that you have armed successfully.





- The default arm/disarm password is 123456. If you want to change it, see "4.4.4.4 General."
- If you selected **Delay** for the alarm status of an area, you will hear the beeps after the delayed duration has passed.

## 4.7.2 Disarm



- Make sure that areas you want to disarm are armed; otherwise you cannot disarm the area.
- If you are forced to enter arm/disarm password to disarm, you can enter the hijacking password (enter the arm/disarm password in reverse order), and then the management center will receive your asking for help information.

## 4.8 Elevator Control

Elevator control modules can be connected to the indoor monitor. You can make the elevator come to your floor through the indoor monitor. Once elevator control module is connected, there is an elevator control button on the main menu of the indoor monitor.

## 4.9 Commissioning

### 4.9.1 Watching Monitoring Videos

Tap .

On the indoor monitor, you can watch videos captured by door stations and IP cameras. You can also put door stations and IP cameras that you like into the **Favorite** folder by tapping  at the lower right corner of each device.

During the call with a door station, you can watch the real-time videos capture by door stations or IP cameras.

Figure 4-48 Monitor (1)

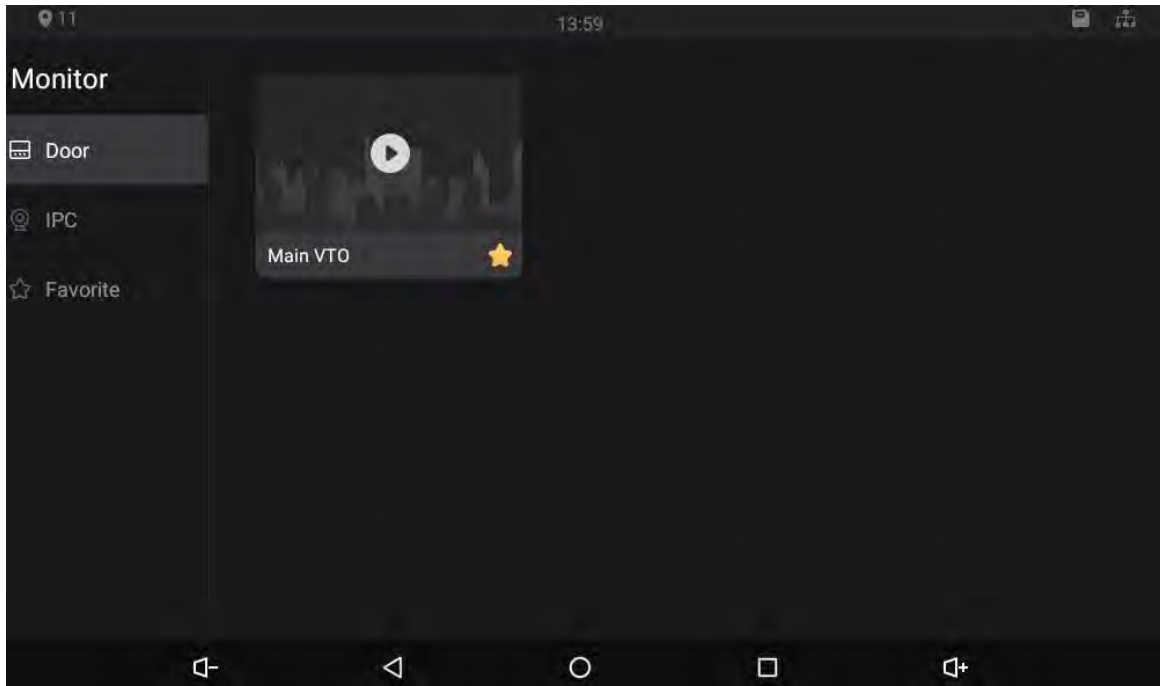

Figure 4-49 Monitor (2)

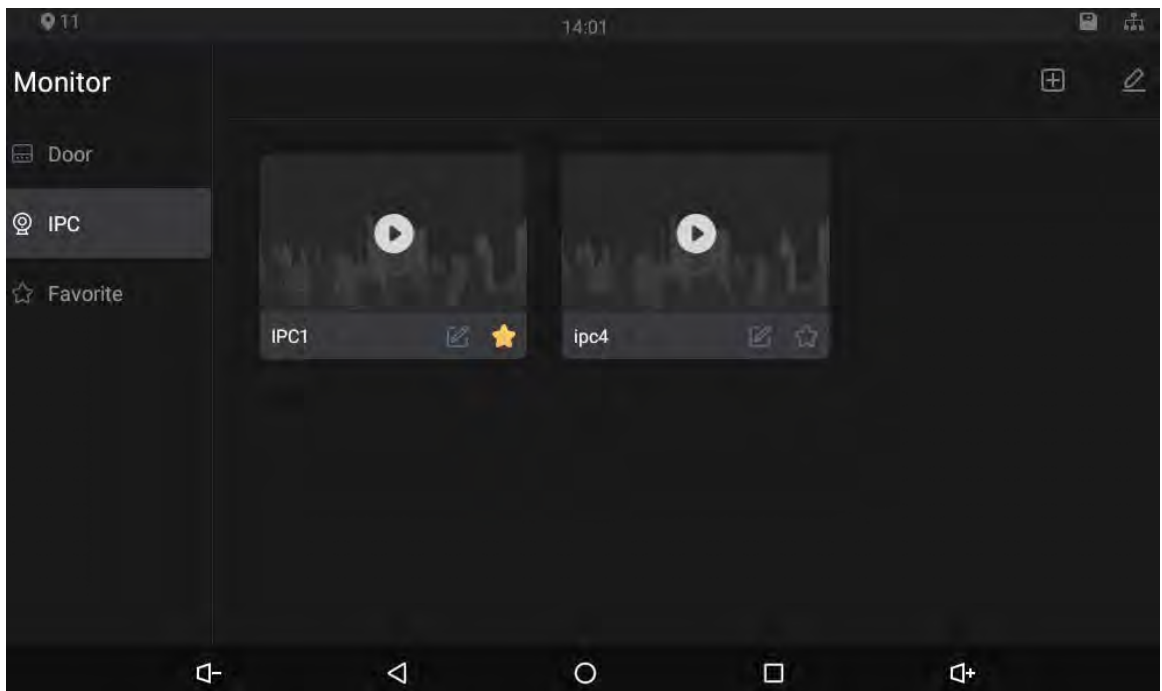
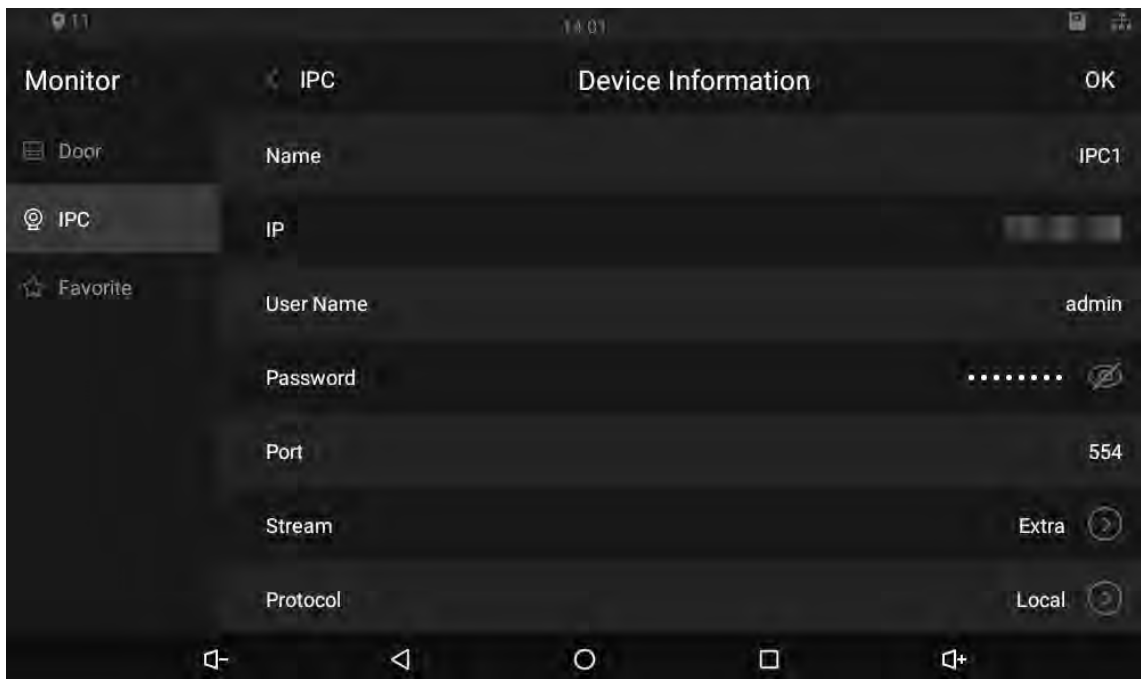







Figure 4-50 IPC information



- : Tap the icon to turn down the volume.
- : Tap the icon to go to the previous page.
- : Tap the icon to go to the main menu.
- : Tap the icon, and all thumbnails of interfaces you have opened will be displayed. Select an interface and slide it to the left or right to close the interface.
- : Tap the icon to turn up the volume.

## 4.9.2 Checking Messages

Tap  on the main menu, and then you can watch videos left by visitors, view snapshots and public notices released by the management center, or delete videos and snapshots.

### 4.9.2.1 Guest Message



This function will be available when SD card is inserted in the indoor monitor, and all messages will be stored in the SD card.

Figure 4-51 Guest message

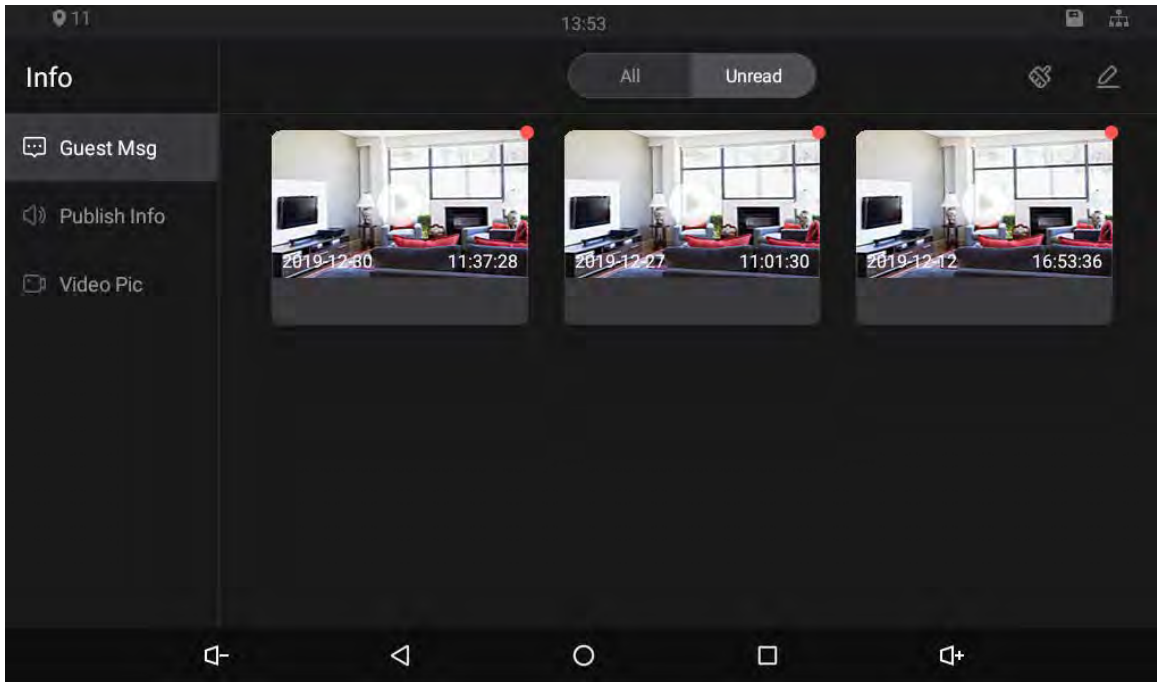

#### 4.9.2.2 Publish Info



Public notices released by the management center are stored in the indoor monitor.

Figure 4-52 Viewing publish information

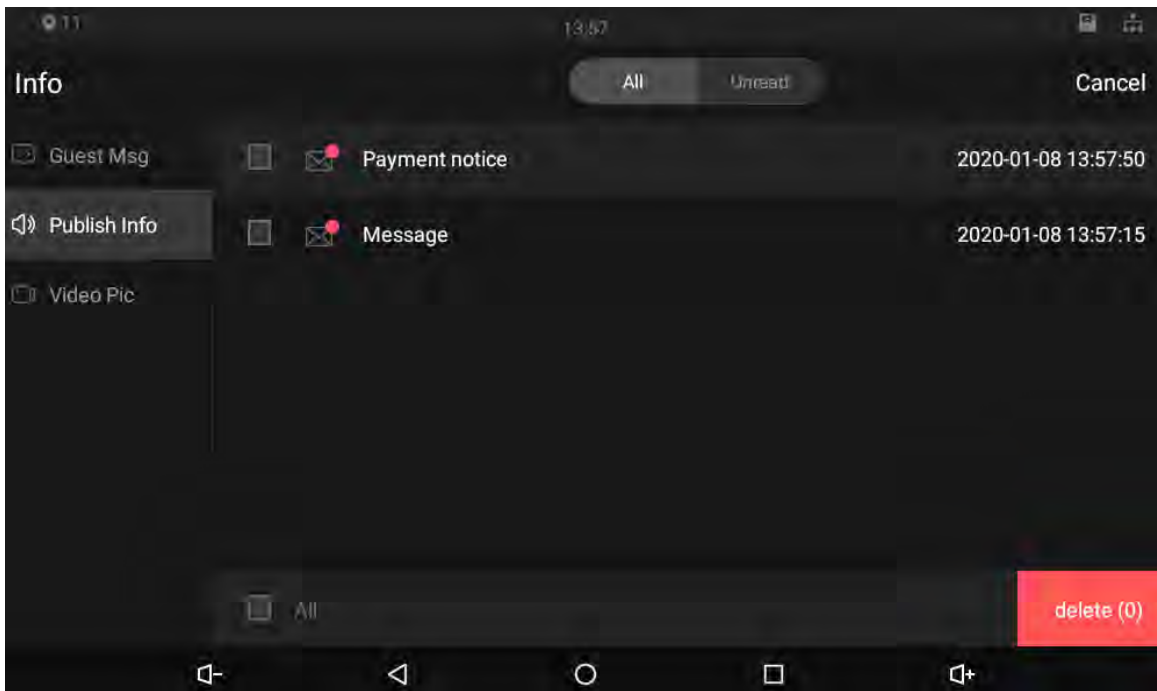

### 4.9.2.3 Video Pic



This function will be available when SD card is inserted in the indoor monitor, and all videos and snapshots will be stored in the SD card.

Figure 4-53 Viewing video pictures

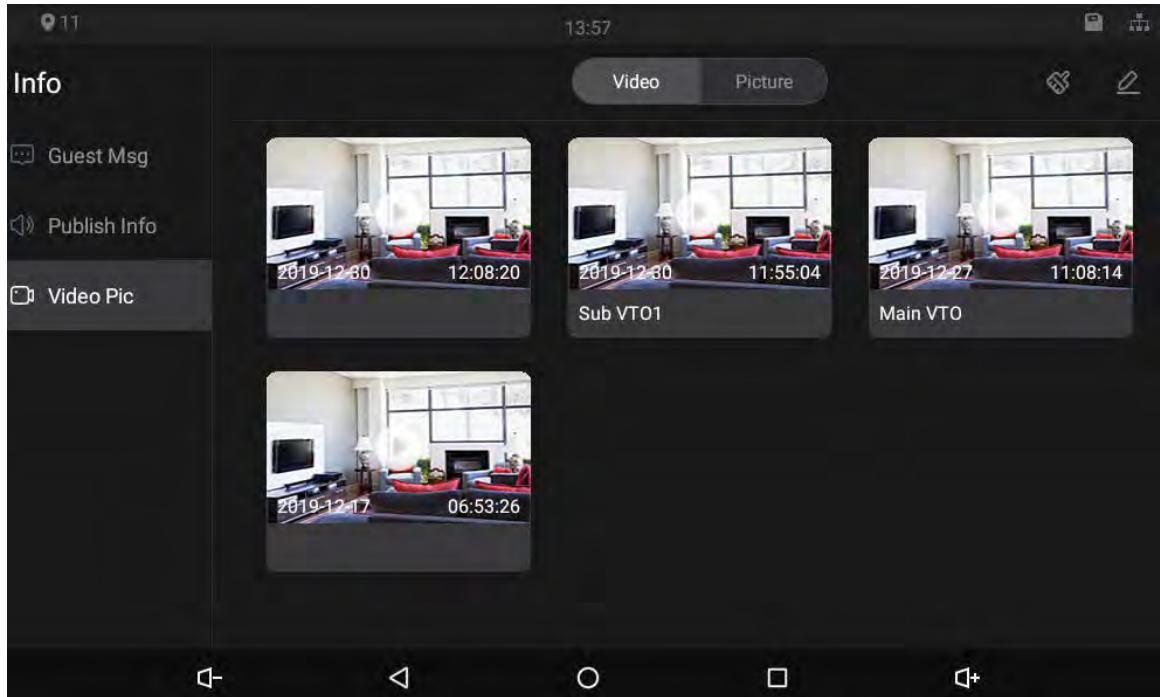

### 4.9.3 Making Calls

Tap , and then you can call other indoor monitors and the management center; and you can also view call logs and your contacts on this interface. You can also call the indoor monitor from door stations.

Figure 4-54 Making calls

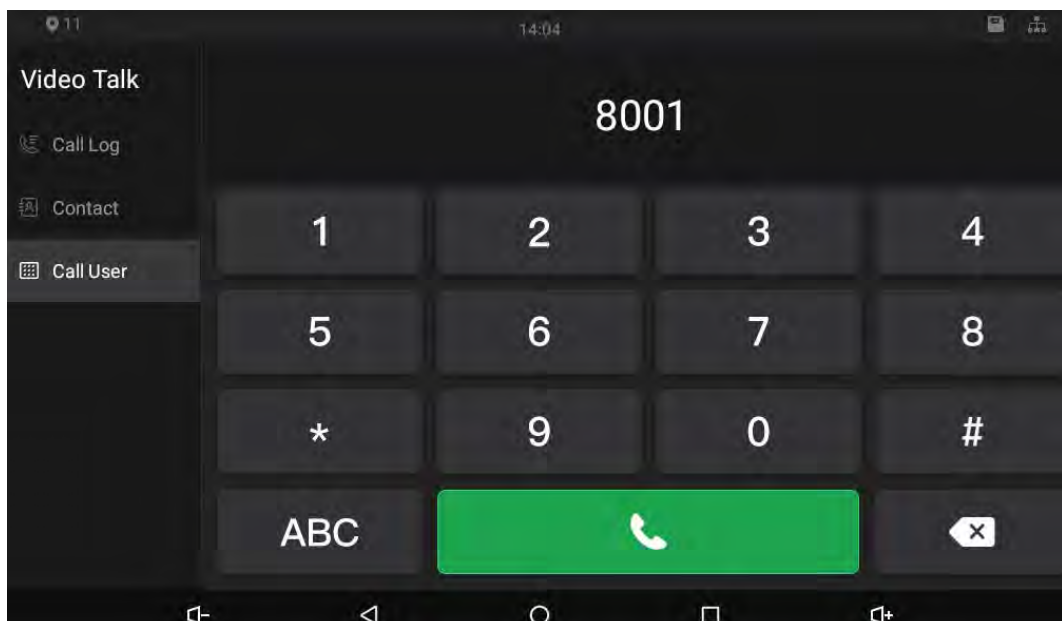
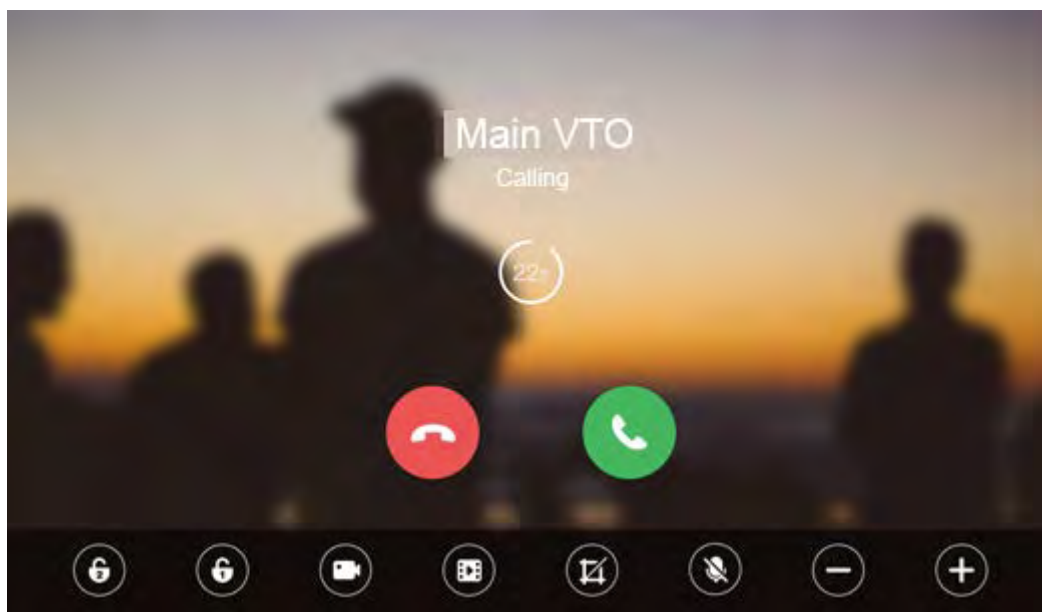





Figure 4-55 Calling



- If SD card is not inserted, the video recording icon  and snapshot icon  cannot be used.
- You can tap the unlock icon   to unlock doors. If the icons turn grey, the unlock function cannot be used.

## Call Residents through Dialing Numbers

Step 1 Tap 

Step 2 Tap **Call User**.

Step 3 Enter room number (room number you entered in the indoor monitor), and then tap .

- If door station (VTO) works as SIP server, enter a room number.
- If management platform like DSS Pro or DSS Express works as SIP server.
  - ◇ Call residents in your apartment or your building, enter a room number.
  - ◇ Call residents in other apartments and buildings, enter 1#1#101 for apartment 1 building 1 room 101.



- If you call the extensions (101#1) from the main indoor monitor (101#0), just enter -1.
- If you call the main indoor monitor from the extensions, just enter -0.

## Call Residents through Contacts

You can also call residents through contacts.

## Call through Call Logs

You can make calls through tapping call records.

# Appendix 1 Cybersecurity Recommendations

Cybersecurity is more than just a buzzword: it's something that pertains to every device that is connected to the internet. IP video surveillance is not immune to cyber risks, but taking basic steps toward protecting and strengthening networks and networked appliances will make them less susceptible to attacks. Below are some tips and recommendations on how to create a more secured security system.

## **Mandatory actions to be taken for basic device network security:**

### **1. Use Strong Passwords**

Please refer to the following suggestions to set passwords:

- The length should not be less than 8 characters;
- Include at least two types of characters; character types include upper and lower case letters, numbers and symbols;
- Do not contain the account name or the account name in reverse order;
- Do not use continuous characters, such as 123, abc, etc.;
- Do not use overlapped characters, such as 111, aaa, etc.;

### **2. Update Firmware and Client Software in Time**

- According to the standard procedure in Tech-industry, we recommend to keep your device (such as NVR, DVR, IP camera, etc.) firmware up-to-date to ensure the system is equipped with the latest security patches and fixes. When the device is connected to the public network, it is recommended to enable the "auto-check for updates" function to obtain timely information of firmware updates released by the manufacturer.
- We suggest that you download and use the latest version of client software.

## **"Nice to have" recommendations to improve your device network security:**

### **1. Physical Protection**

We suggest that you perform physical protection to device, especially storage devices. For example, place the device in a special computer room and cabinet, and implement well-done access control permission and key management to prevent unauthorized personnel from carrying out physical contacts such as damaging hardware, unauthorized connection of removable device (such as USB flash disk, serial port), etc.

### **2. Change Passwords Regularly**

We suggest that you change passwords regularly to reduce the risk of being guessed or cracked.

### **3. Set and Update Passwords Reset Information Timely**

The device supports password reset function. Please set up related information for password reset in time, including the end user's mailbox and password protection questions. If the information changes, please modify it in time. When setting password protection questions, it is suggested not to use those that can be easily guessed.

### **4. Enable Account Lock**

The account lock feature is enabled by default, and we recommend you to keep it on to guarantee the account security. If an attacker attempts to log in with the wrong password several times, the corresponding account and the source IP address will be locked.

### **5. Change Default HTTP and Other Service Ports**

We suggest you to change default HTTP and other service ports into any set of numbers between 1024~65535, reducing the risk of outsiders being able to guess which ports you are using.

## **6. Enable HTTPS**

We suggest you to enable HTTPS, so that you visit Web service through a secure communication channel.

## **7. MAC Address Binding**

We recommend you to bind the IP and MAC address of the gateway to the device, thus reducing the risk of ARP spoofing.

## **8. Assign Accounts and Privileges Reasonably**

According to business and management requirements, reasonably add users and assign a minimum set of permissions to them.

## **9. Disable Unnecessary Services and Choose Secure Modes**

If not needed, it is recommended to turn off some services such as SNMP, SMTP, UPnP, etc., to reduce risks.

If necessary, it is highly recommended that you use safe modes, including but not limited to the following services:

- SNMP: Choose SNMP v3, and set up strong encryption passwords and authentication passwords.
- SMTP: Choose TLS to access mailbox server.
- FTP: Choose SFTP, and set up strong passwords.
- AP hotspot: Choose WPA2-PSK encryption mode, and set up strong passwords.

## **10. Audio and Video Encrypted Transmission**

If your audio and video data contents are very important or sensitive, we recommend that you use encrypted transmission function, to reduce the risk of audio and video data being stolen during transmission.

Reminder: encrypted transmission will cause some loss in transmission efficiency.

## **11. Secure Auditing**

- Check online users: we suggest that you check online users regularly to see if the device is logged in without authorization.
- Check device log: By viewing the logs, you can know the IP addresses that were used to log in to your devices and their key operations.

## **12. Network Log**

Due to the limited storage capacity of the device, the stored log is limited. If you need to save the log for a long time, it is recommended that you enable the network log function to ensure that the critical logs are synchronized to the network log server for tracing.

## **13. Construct a Safe Network Environment**

In order to better ensure the safety of device and reduce potential cyber risks, we recommend:

- Disable the port mapping function of the router to avoid direct access to the intranet devices from external network.
- The network should be partitioned and isolated according to the actual network needs. If there are no communication requirements between two sub networks, it is suggested to use VLAN, network GAP and other technologies to partition the network, so as to achieve the network isolation effect.
- Establish the 802.1x access authentication system to reduce the risk of unauthorized access to private networks.
- Enable IP/MAC address filtering function to limit the range of hosts allowed to access the device.