



FULL CONTROL BOARD MANUAL

ALENA SW2 CPEM



D814393 0ADA0_02_07-02-24

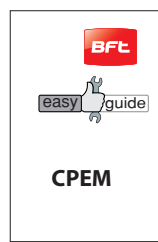
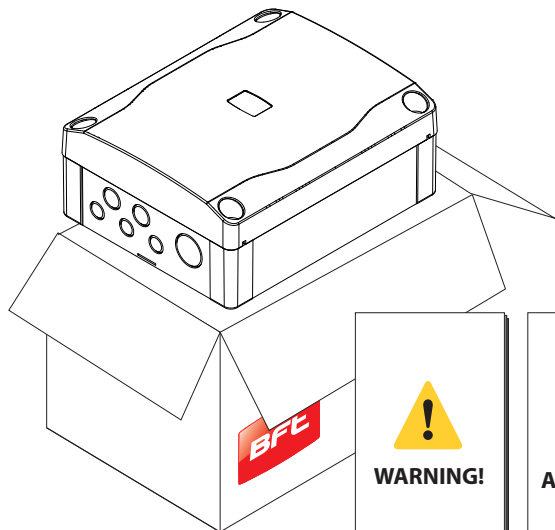

 ac	220-230V~ 50/60Hz 110-120V~ 50/60Hz
	-20°C
	+55°C
IP	55

DIP SWITCH + TRIMMER + TASTI PROGRAMMAZIONE
 DIP SWITCH + TRIMMER + PROGRAMMING KEYS
 COMMUTATEURS DIP + DÉCLENCHEURS + TOUCHES PROGRAMMATION
 DIP SWITCH + TRIMMER + PROGRAMMIERUNGSTASTEN
 DIP SWITCH + TRIMMER + BOTONES PROGRAMACIÓN
 DIP SWITCHES + TRIMMERS + PROGRAMMERINGSTOETSEN
 DIP SWITCH + TRIMMER + TECLAS DE PROGRAMAÇÃO
 DIP SWITCH + TRIMMER + ΜΠΟΥΤΟΝ ΠΡΟΓΡΑΜΜΑΤΙΣΜΟΥ
 DIP SWITCH + TRIMMER + PROGRAMLAMA TUŞLARI
 DIP-ПЕРЕКЛЮЧАТЕЛЯ + РЕЗИСТОРОВ + ПРОГРАМОВАЦІ ПЛАТІТКА
 DIP SPÍNAČŮ. + ČASOVÝCH SPÍNAČŮ + KLAVIŠI PROGRAMMÍROVANIA
 DIP SWITCH + TRIMMER + PRZYCISKI PROGRAMOWANIA
 DIP PREKIDAČ + TRIMMER + TIPKE ZA PROGRAMIRANJE
 COMUTATOR DIP + TRIMMER + TASTE DE PROGRAMARE

مفتاح DIP + وحدة الضبط + مفاتيح البرمجة

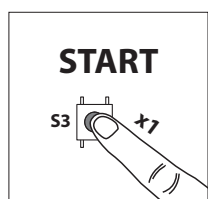

F1 3.15 AF (~230V)
6.3 AF (~120V)

F2 100mAT (~230V)
200mAT (~120V)

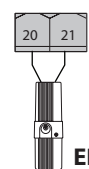
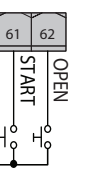
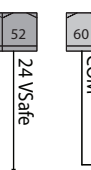
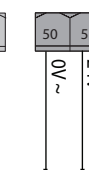
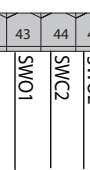
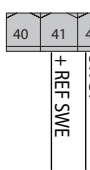
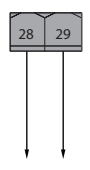
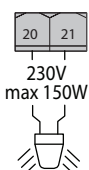
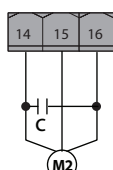
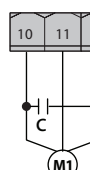
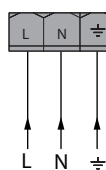
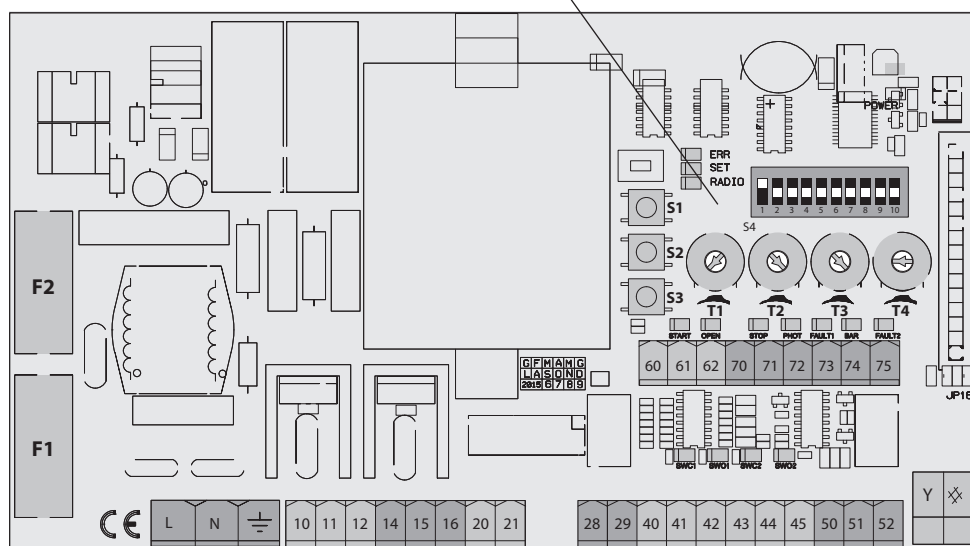

AUTOSET PER MOTORI CON FINECURSA
AUTOSET FOR MOTORS WITH LIMIT SWITCHES
AUTOCONFIGURATION POUR MOTEURS AVEC FIN DE COURSE
AUTOSET FÜR MOTOREN MIT ENDSCHALTER
AUTOSET PARA MOTORES CON FINAL DE CARRERA
AUTOSET VOOR MOTOREN MET EINDAANSLAGEN
AUTOSET PARA MOTORES COM FIM DE CURSO
AUTOSET ГИА МОТЕП МЕ ТЕРМАТИКА

AUTOMATYCZNE USTAWIENIE DLA SILNIKÓW Z WYŁĄCZNIKIEM KRAŃCOWYM
АВТОМАТИЧЕСКАЯ НАСТРОЙКА ДЛЯ ДВИГАТЕЛЕЙ С КОНЦЕВЫМИ ВЫКЛЮЧАТЕЛЯМИ
SAMONASTAVENÍ PRO MOTORY S KONCOVÝM SPÍNAČEM
LIMIT SVIČLI MOTORLAR İÇİN AUTOSET (OTOMATİK AYAR)
AUTOPOSTAVKE ZA MOTORE S KRAJNJOM SKLOPKOM
SETARE AUTOMATĂ PENTRU MOTOARE CU LIMITATOARE
ضبط تلقائي للمحركات المجهزة بمفاتيح حدية

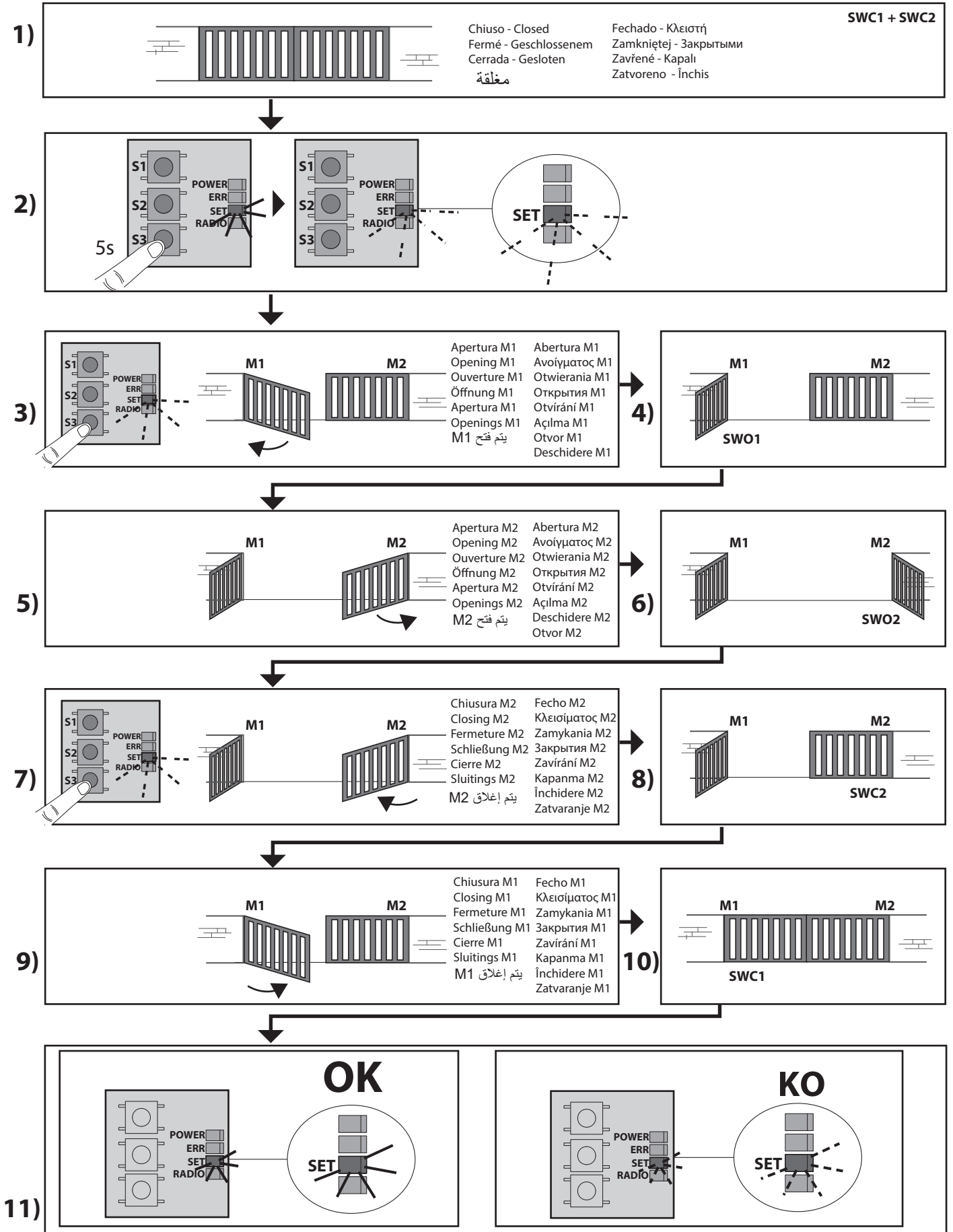

AUTOSET PER MOTORI SPROVVISTI DI FINECORSA
AUTOSET FOR MOTORS WITH NO LIMIT SWITCHES
AUTOCONFIGURATION POUR MOTEURS SANS FIN DE COURSE
AUTOSET FÜR MOTOREN OHNE ENDSCHALTER
AUTOSET PARA MOTORES SIN FINAL DE CARRERA
AUTOSET VOOR MOTOREN ZONDER EINDAANSLAGEN
AUTOSET PARA MOTORES DESPROVIDOS DE FIM DE CURSO
AUTOSET ΓΙΑ ΜΟΤΕΡ ΧΩΡΙΣ ΤΕΡΜΑΤΙΚΑ

AUTOMATYCZNE USTAWIENIE DLA SILNIKÓW BEZ WYŁĄCZNIKA KRAŃCOWEGO
АВТОМАТИЧЕСКАЯ НАСТРОЙКА ДЛЯ ДВИГАТЕЛЕЙ БЕЗ КОНЦЕВЫХ ВЫКЛЮЧАТЕЛЕЙ
SAMONASTAVENÍ PRO MOTORY BEZ KONCOVÉHO SPÍNAČE
LIMIT SVIČSİZ MOTORLAR İÇİN AUTOSET (OTOMATİK AYAR)
AUTOPOSTAVKE ZA MOTORE BEZ KRAJNJE SKLOPKE
SETARE AUTOMATĂ PENTRU MOTOARE FĂRĂ LIMITATOARE
ضبط تلقائي للمحركات المجهزة دون مفاتيح حدية

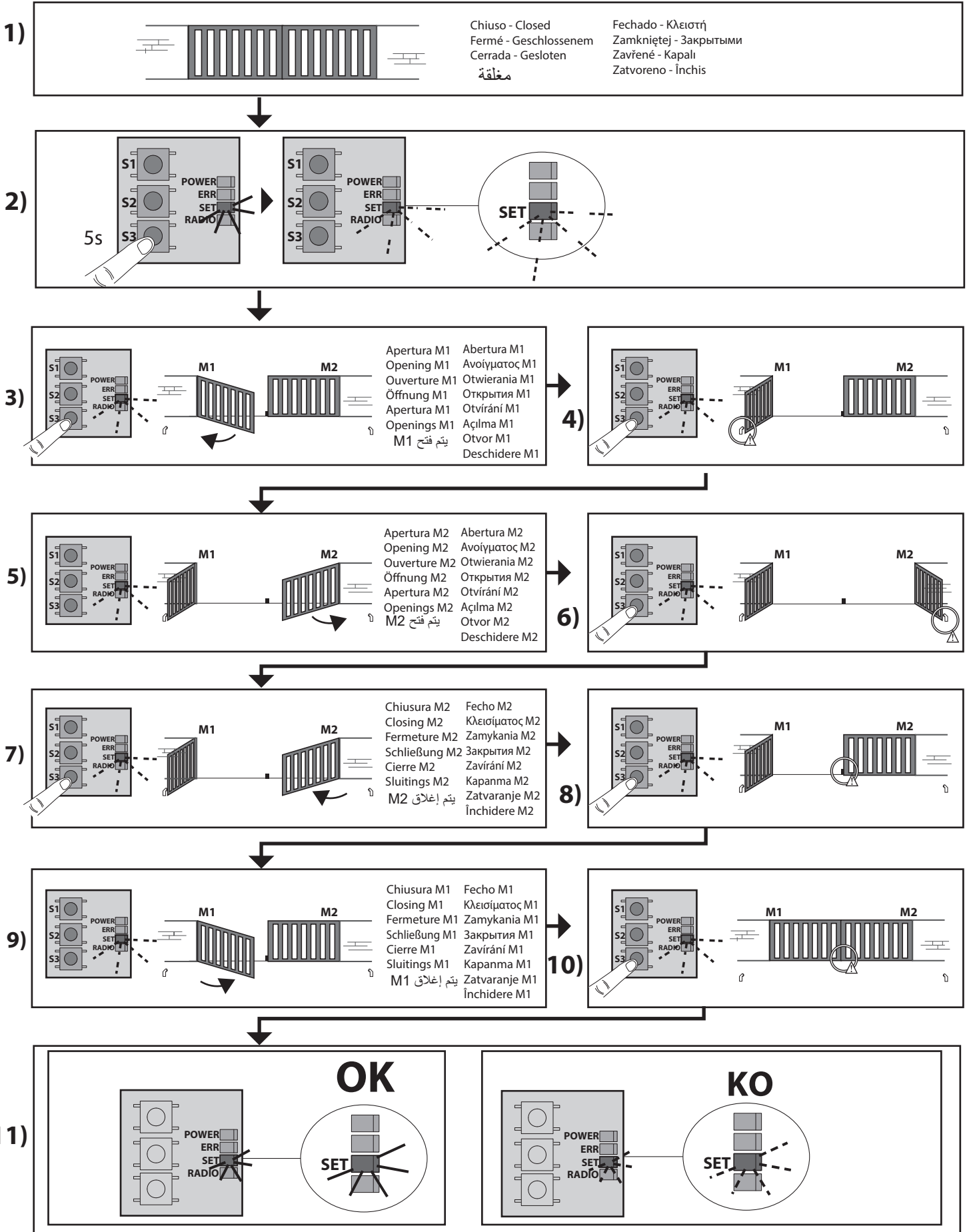

((€-Ready))



AZIENDA CON
SISTEMA DI GESTIONE
CERTIFICATO DA DNV GL
= ISO 9001 =
= ISO 14001 =



 www.bft-automation.com BFT Spa Via Lago di Vico, 44 ITALY 36015 Schio (VI) T +39 0445 69 65 11 F +39 0445 69 65 22	SPAIN BFT GROUP ITALIBERICA DE AUTOMATISMOS SL Camí de Can Bassa, 6, 08401 Granollers, Barcelona, Spagna	UNITED KINGDOM BFT AUTOMATION UK LTD Unit C2-C3 The Embankment Business Park, Vale Road Heaton Mersey Stockport Cheshire SK4 3GL United Kingdom	IRELAND BFT AUTOMATION IRELAND Unit D3 City Link Business Park, Old Naas Road, Dublin	U.S.A. BFT AMERICAS INC. 1200 S.W. 35th Avenue Suite B Boynton Beach FL 33426
	FRANCE AUTOMATISMES BFT FRANCE SAS 50 rue jean zay 69800 Saint-Priest, Francia	BFT AUTOMATION (SOUTH) LTD Enterprise House Murdock Road, Dorcan, Swindon, England, SN3 5HY	CROATIA BFT ADRIA DOO Obrovac 39, 51218, Dražice, Croazia	AUSTRALIA BFT AUTOMATION AUSTRALIA PTY 29 Bentley St, Wetherill Park NSW 2164, Australia
	GERMANY BFT ANTRIEBSSYSTEME GMBH Faber-Castell-Straße 29, 90522 Oberasbach, Germania	PORTUGAL BFT PORTUGAL SA Urb. Pedrulha lote 9 - Apartado 8123, 3025-248 Coimbra Portugal	CZECH REPUBLIC BFT CZ SRO Ustecka 533/9, 184 00 Praha 8, Czech	EMIRATES BFT MIDDLEEAST FZCO FZS2 AA01 -PO BOX 262200, Jebel Ali Free Zone South Zone 2 , Dubai - United Arab
		POLAND BFT POLSKA SP ZOO Marecka 49, 05-220 Zielonka, Polonia	TURKEY BFT OTOMASYON KAPI Şerifali Mahallesi, no, 34775 Ümraniye/Istanbul, Turchia	NEW ZEALAND BFT AUTOMATION NEW ZEALAND 224/A Bush Road, Rosedale, Auckland, New Zealand