



FULL MANUAL

<https://www.bft-automation.com/qrcodemanual/D814283>

THALIA BT A80/A160



D814375 0ADAO_06 23-07-24

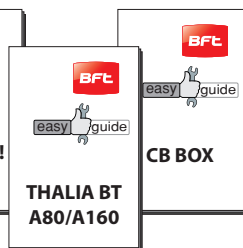
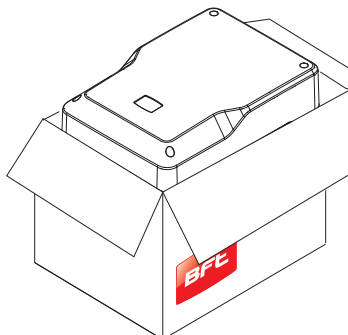

DUO

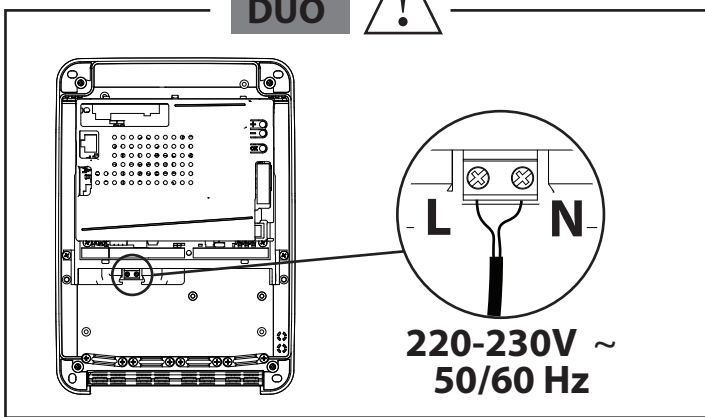

220-230V ~
50/60 Hz

FLAT

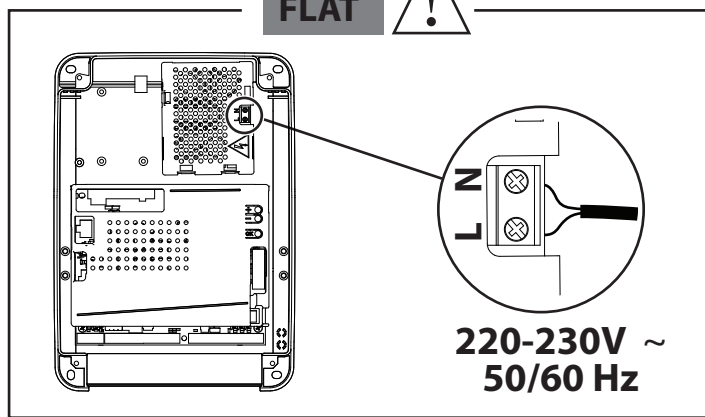

220-230V ~
50/60 Hz

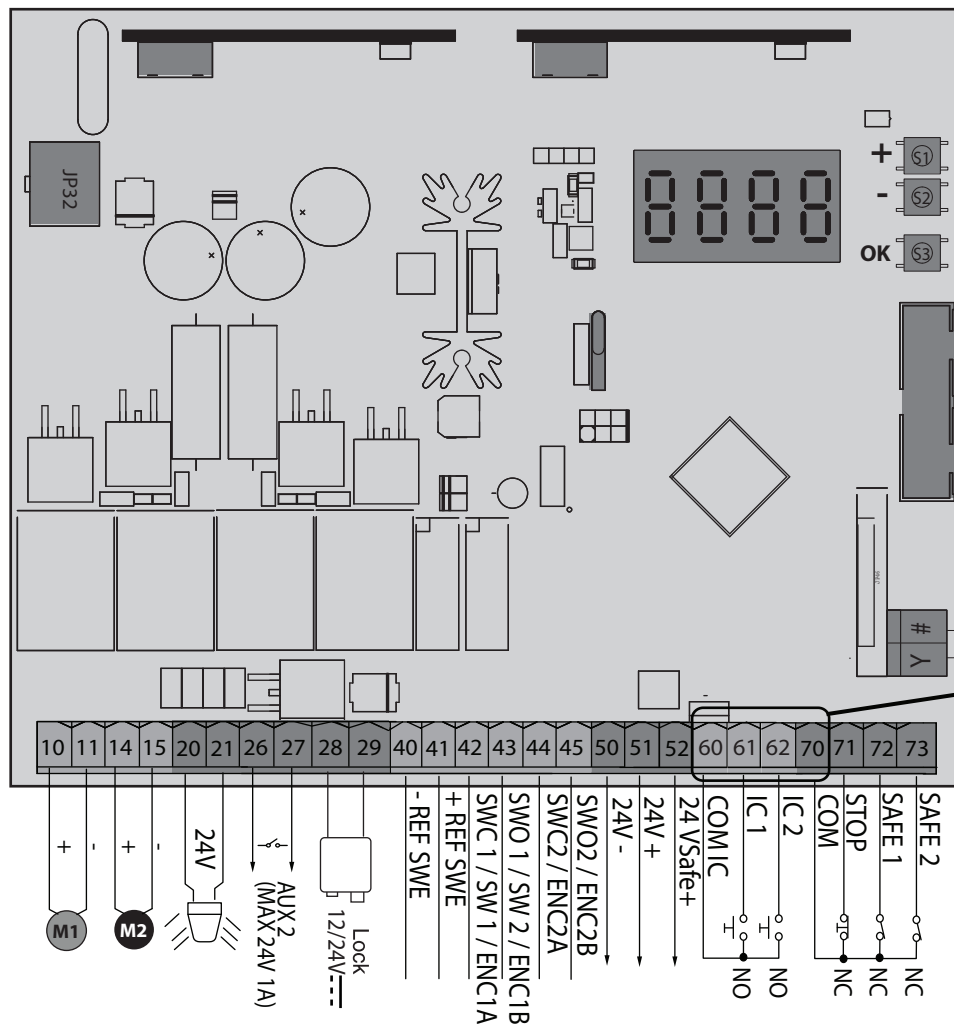

	THALIA BT A80	THALIA BT A160
	220-230 V 50/60 Hz	
P stand-by	0,48 W	
Pmax	200 W	400 W
	433,92 MHz	
IP	DUO	DUO
	45	45
	-20°C / +60°C	-20°C / +55°C

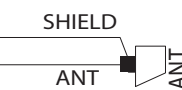

07 COM

09 COM IC

COM ≠ COM IC

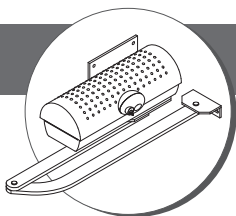

IGEA BT

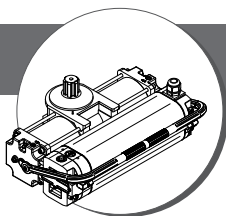
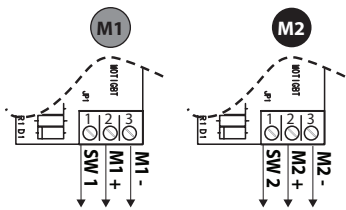
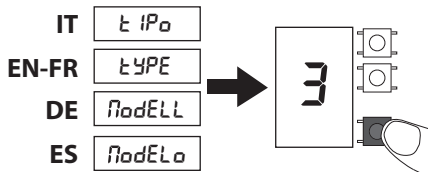

SUB BT

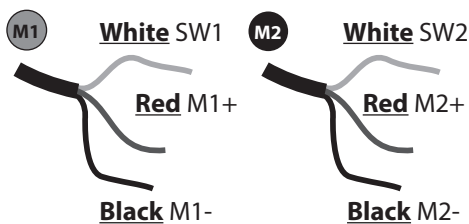
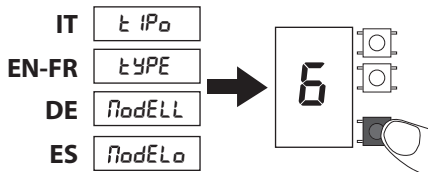

White Bianco - Blanc - Weiß - Blanco - Wit - Brancov - Λευκή - biały - белый - bílá - Ak - Bijela - Alb - أبيض
Red Rosso - Roug - Rot - Rojo - Rood - Vermelho - κόκκινο - czerwony - красный - červený - kırmızı - Crvena - Roşu - أحمر
Black Nero - Noir - Nero - Negro - Zwart - Preto - μαύρο - czarny - черный - černý - siyah - Crno - Negro - أسود

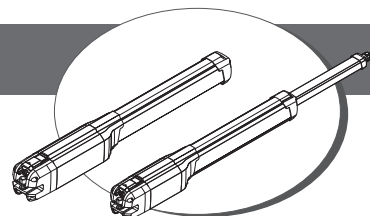
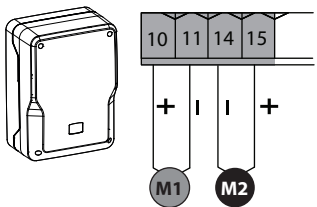

**PHOBOS BT A - PHOBOS BT B
KUSTOS BT A - KUSTOS BT B**

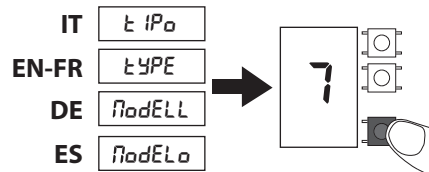

PHOBOS VELOCE BT B35

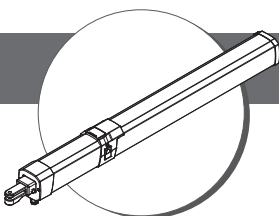
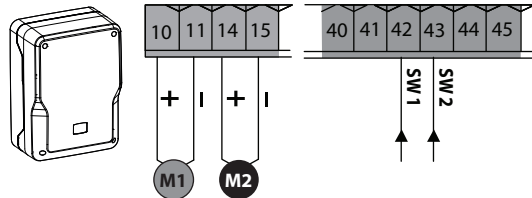
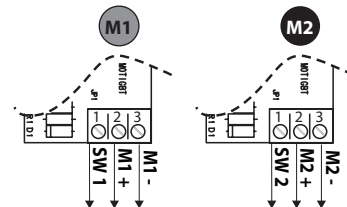
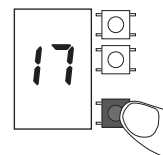

GIUNO ULTRA

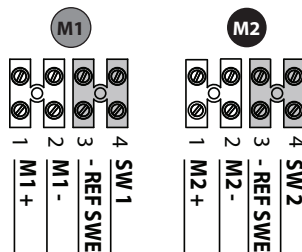
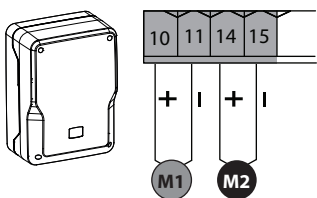
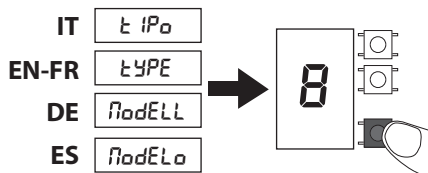

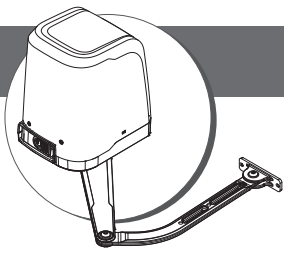

VIRGO SMART BT A SLAVE

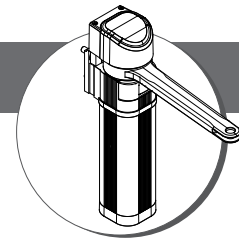
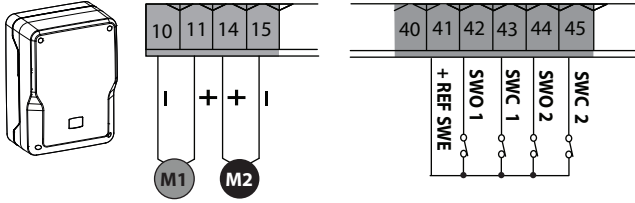
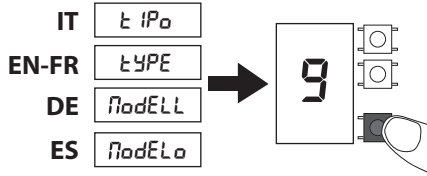

E5 BT A 18

E5 BT A 12

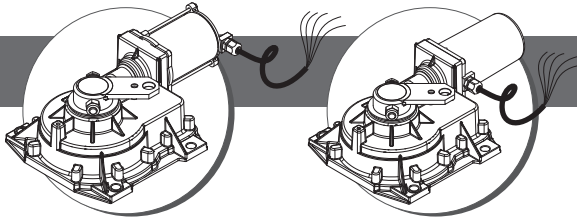
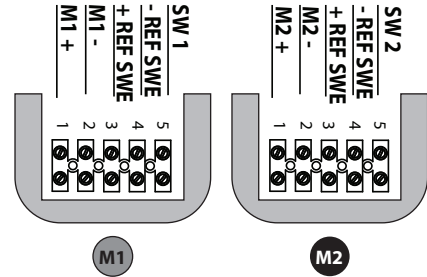
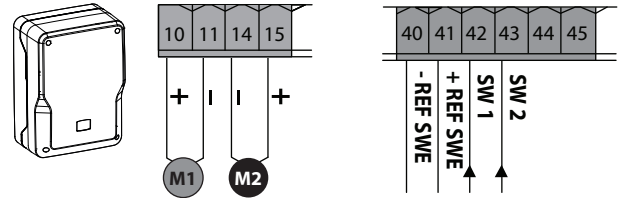
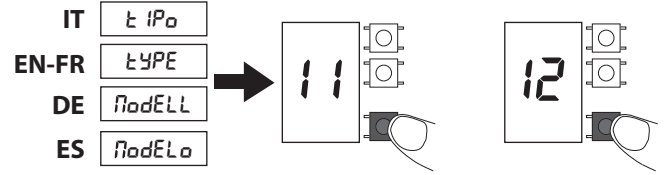

ELI BT A40

ELI BT A35V

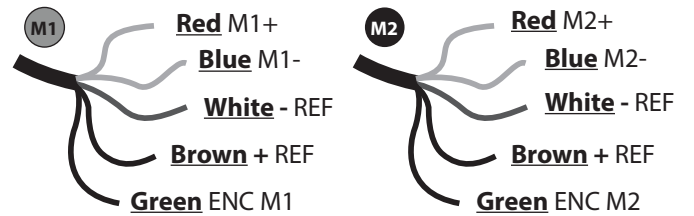
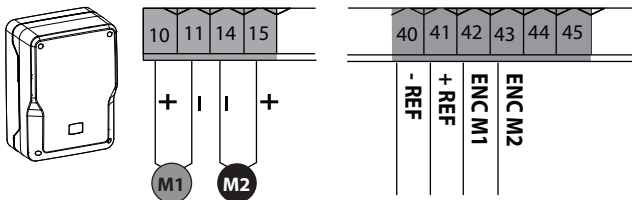
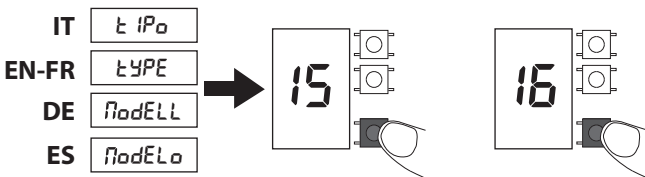

Red: Rosso - Roug - Rot - Rojo - Rood - Vermelho - κόκκινο - czerwony - красный - červený - kırmızı - Crvena - Roşu - أحمر

Bleu: Blu - Bleu - Blau Azul - Blauw - Azul Μπλε - niebieski - синий - mo-dro - mavi - Plava - alabastru - أزرق

White: Bianco - Blanc - Weiß - Blanco - Wit - Brancov - Λευκή - biały - белый - bílá - Ak - Bijela - Alb - أبيض

Brown: Marrone - Marron Braun - Maron - bruin - Castanho - καφέ - brązowy - коричневый - hnědý - kahverengi - Smeđa - Marro - بني

Green: Verde - Vert - Grün Verde - Groen - Verde Πράσινη - Gre-enЗеленый - Zelená - Yeşil - Zelena - Verde - أخضر

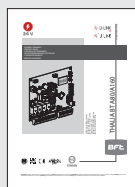
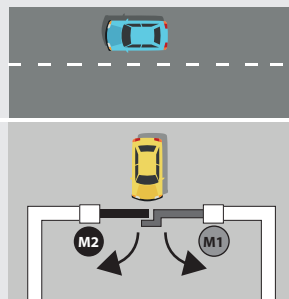

<https://www.bft-automation.com/qrcodemanual/D814283>

COME PROGRAMMARE LA SCHEDA - HOW TO PROGRAM THE BOARD
 COMMENT PROGRAMMER LA CARTE - PROGRAMMIERUNG DER REGISTERKARTE
 CÓMO PROGRAMAR LA TARJETA - HOE DE KAART TE PROGRAMMEREN
 COMO PROGRAMAR A PLACA - ΤΡΟΠΟΣ ΠΡΟΓΡΑΜΜΑΤΙΣΜΟΥ ΤΗΣ ΠΛΑΚΕΤΑΣ
 JAK ZAPROGRAMOWAĆ KARTĘ - ΠΡΟΓΡΑΜΜΙΟΒΑΝΗΕ ΠΛΑΤΥ
 JAK NAPROGRAMOVAT KARTU - KARTIN NASIL PROGRAMLANACAĞI
 KAKO PROGRAMIRATI PLOČU - CUM SE PROGRAMEAZĂ PLACA DE CIRCUITE -
 كيفية برمجة المجلس

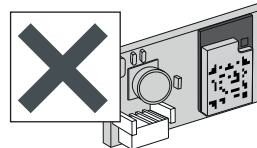
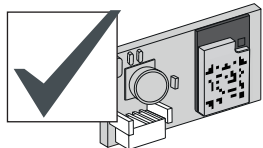

1

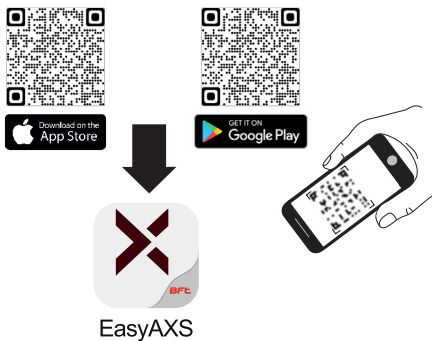

2

(IT) Programmo il quadro con APP
 (EN) Programming the panel with APP
 (FR) Programmation du panneau avec APP
 (DE) Programmierung des Panels über die APP
 (ES) Programación del cuadro con APP
 (NL) Ik programmeer het paneel met de APP
 (PT) Programação do painel com APP
 (EL) Προγραμματίζω το πλαίσιο με την APP
 (PL) Programowanie centrali za pomocą aplikacji
 (RU) Программирование пульта с приложением
 (CS) Programování panelu pomocí aplikace
 (TR) Çerçeveyi APP ile programlıyorum
 (HR) Programiranje ploče pomoću aplikacije
 (RO) Program cu panou cu aplicatie
 (AR) برمجة اللوحة باستخدام التطبيق

(IT) Programmo quadro da display
 (EN) Programming the panel from the display
 (FR) Programmation du panneau à partir de l'écran
 (DE) Programmierung des Panels über das Display
 (ES) Programación del cuadro desde la pantalla
 (NL) Ik programmeer het paneel via het display
 (PT) Programação do painel a partir do ecrã
 (EL) Προγραμματίζω τον πίνακα από την οθόνη
 (PL) Programowanie centrali z poziomu wyświetlacza
 (RU) Программирование пульта через дисплей
 (CS) Programování panelu z displeje
 (TR) Paneli ekrandan programlıyorum
 (HR) Programiranje ploče preko zaslona
 (RO) Program cu panou cu ecran
 (AR) برمجة اللوحة من الشاشة



AZIENDA CON
 SISTEMA DI GESTIONE
 CERTIFICATO DA DNV GL
 = ISO 9001 =
 = ISO 14001 =



U-Security



24 V



BFT
www.bft-automation.com
BFT Spa
 Via Lago di Vico, 44 ITALY
 36015 Schio (VI)
 T +39 0445 69 65 11
 F +39 0445 69 65 22

SPAIN
BFT GROUP ITALIBERICA DE AUTOMATISMOS SL
 Camí de Can Bassa, 6, 08401 Granollers, Barcelona, Spagna

FRANCE
AUTOMATISMES BFT FRANCE SAS
 50 rue jean zay
 69800 Saint-Priest, Francia

GERMANY
BFT ANTRIEBSSYSTEME GMBH
 Faber-Castell-Straße 29, 90522 Oberasbach, Germania

UNITED KINGDOM
BFT AUTOMATION UK LTD
 Unit C2-C3 The Embankment Business Park, Vale Road Heaton Mersey Stockport Cheshire SK4 3GL United Kingdom

BFT AUTOMATION (SOUTH) LTD
 Enterprise House Murdock Road, Dorcan, Swindon, England, SN3 5HY

PORTUGAL
BFT PORTUGAL SA
 Urb. Pedrulha lote 9 - Apartado 8123, 3025-248 Coimbra Portugal

POLAND
BFT POLSKA SP ZOO
 Marecka 49, 05-220 Zielonka, Polonia

IRELAND
BFT AUTOMATION IRELAND
 Unit D3 City Link Business Park, Old Naas Road, Dublin

CROATIA
BFT ADRIA DOO
 Obrovac 39, 51218, Dražice, Croazia

CZECH REPUBLIC
BFT CZ SRO
 Ustecka 533/9, 184 00 Praha 8, Czech

TURKEY
BFT OTOMASYON KAPI
 Şerifali Mahallesi, no, 34775 Ümraniye/Istanbul, Turchia

U.S.A.
BFT AMERICAS INC.
 1200 S.W. 35th Avenue Suite B Boynton Beach FL 33426

AUSTRALIA
BFT AUTOMATION AUSTRALIA PTY
 29 Bentley St, Wetherill Park NSW 2164, Australia

EMIRATES
BFT MIDDLEEAST FZCO
 FZS2 AA01 - PO BOX 262200, Jebel Ali Free Zone South Zone 2, Dubai - United Arab

NEW ZEALAND
BFT AUTOMATION NEW ZEALAND
 224/A Bush Road, Rosedale, Auckland, New Zealand