

INSTALLATION INSTRUCTIONS



N219



High Mount
Outdoor Detector

HX-40/40AM

By **utilising** the OPTEX's unique pyro-element, HX series achieves high reliable detection performance against false and missed alarms. HX series provides stable and accurate detection in outdoor severe environmental conditions.

- HX-40** : standard model with two PIRs
- HX-40AM** : HX-40 with IR anti-masking feature

CONTENTS

(1) INSTALLATION HINTS	1
(2) PARTS IDENTIFICATION	2
(3) KNOCKOUTS	2
(4) DETECTION AREA SETTING	3
(5) INSTALLATION	3
(6) BRACKET INSTALLATION AND ADJUSTMENT ..	4
(7) WIRING	6
(8) FUNCTION SETTING	7
(9) OPERATION TEST	9
(10) LED FUNCTIONS	10
(11) SPECIFICATIONS	11

1 INSTALLATION HINTS

⚠ Warning	⚠ Warning	⚠ Caution
<p>Never repair or modify product</p>	<p>Do not pour water over the product</p>	<p>Mount securely</p>

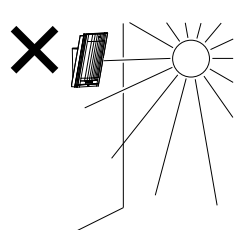
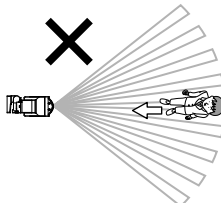
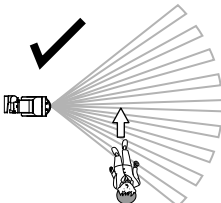
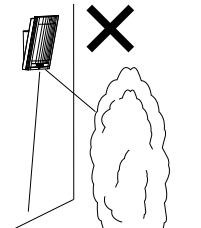
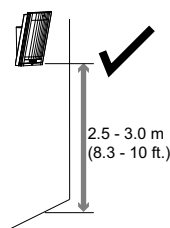
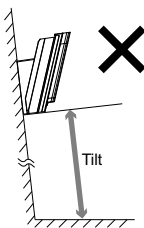
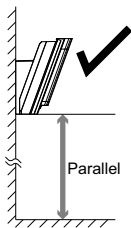

Mount the detector so that a majority of traffic flow is across the detection pattern.

2 PARTS IDENTIFICATION

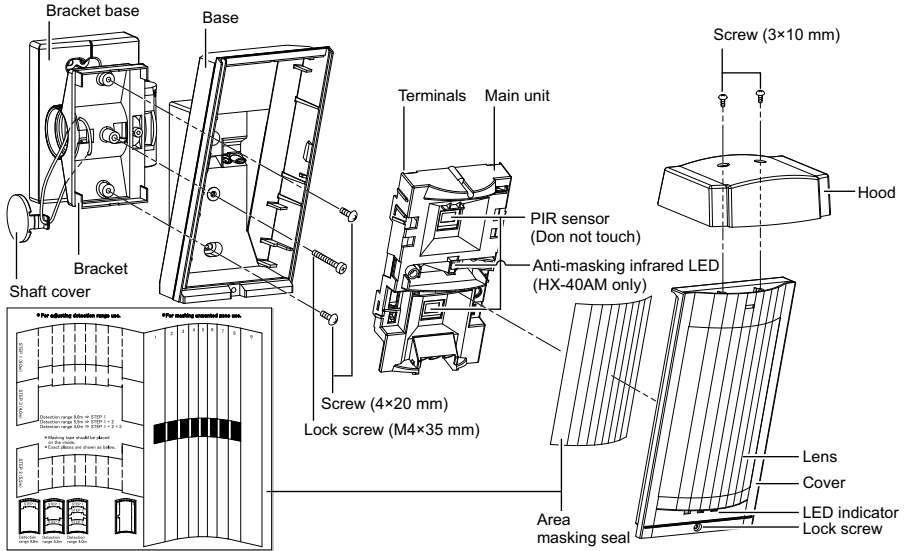

3 KNOCKOUTS

3-A Main unit

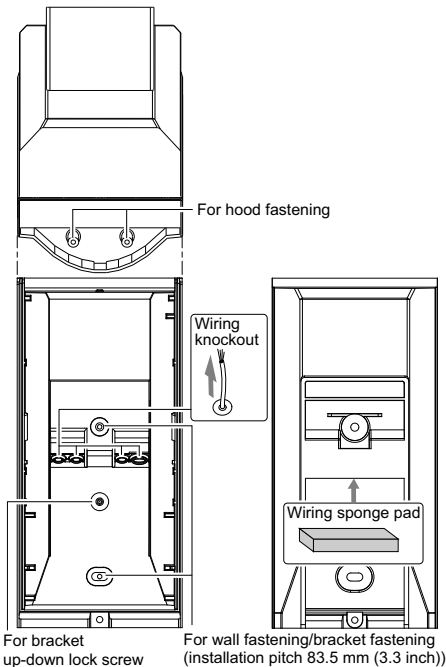

3-B Bracket

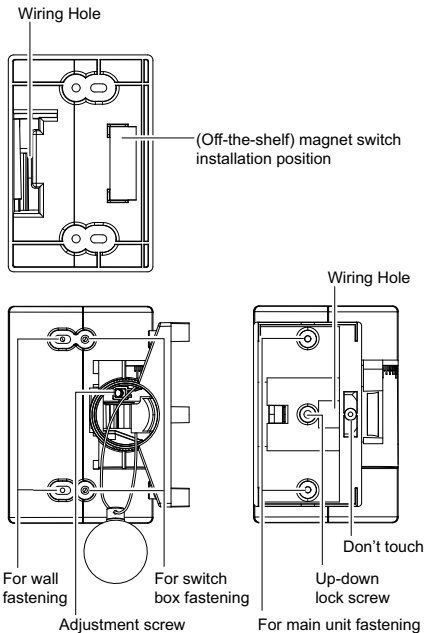

4 DETECTION AREA SETTING

4-A Detection Area

Side view of detection area
(Installation height 3.0 m (1 ft.))

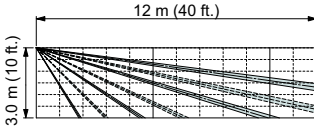

(Installation height 2.5 m)

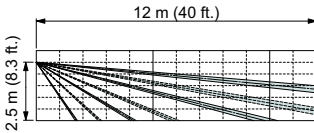

Top view of detection area

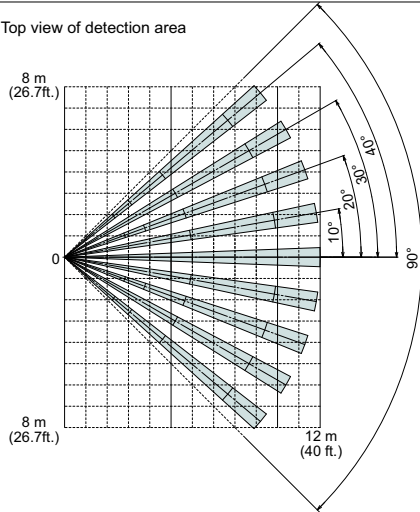

4-B Detection Length Adjustment

To limit the detection distance, apply the appropriate masking seal. Note that there are three different types of seal.

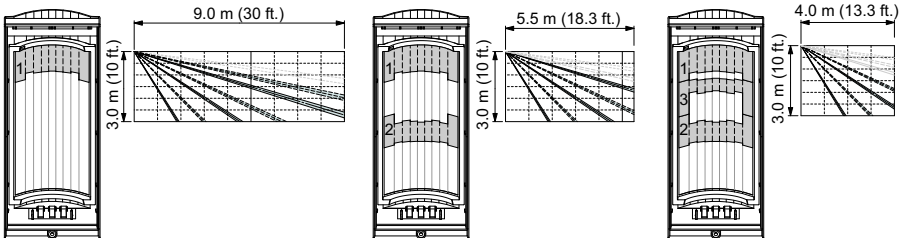

5 INSTALLATION

1 Pass the wire through the base knockout.

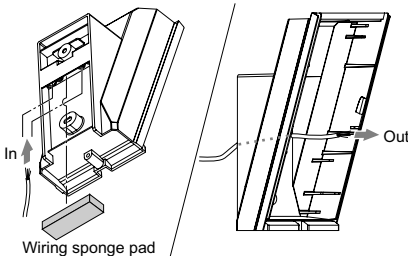

2 Fasten the base to the wall.

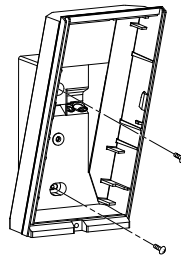

6

BRACKET INSTALLATION AND ADJUSTMENT

Using the bracket makes it possible to adjust the unit through 180° degree.

In cases where the ground is uneven and therefore not parallel with the base of the unit, it is possible to adjust the unit vertically by +/- 20 degree (see section 6-B)

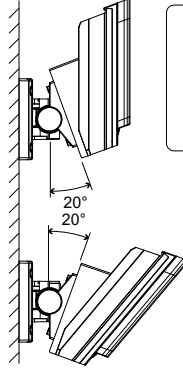
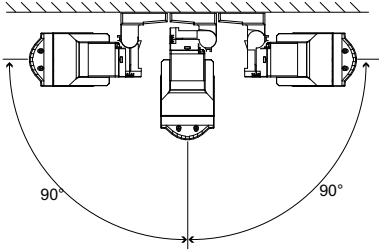

Caution>>

Do not change the detection distance with bracket.
Use the masking seal to adjust the detection distance.

6-A Bracket installation

- 1 Push the shaft cover clip outwards to remove the cover.

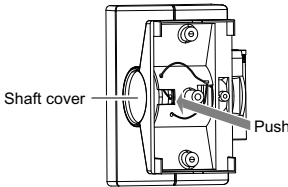

- 2 Loosen the adjustment screw, tilt the bracket about 45° and pass through the wire.

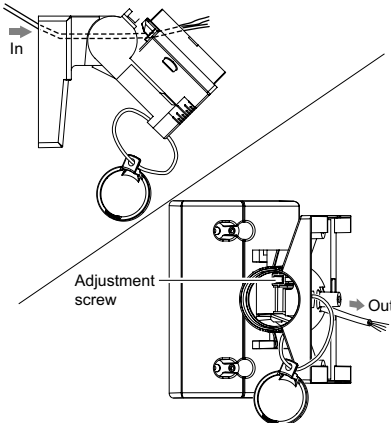

- 3 Fasten the bracket to the wall. Change the bracket direction according to whether the Main unit is to face left or right.

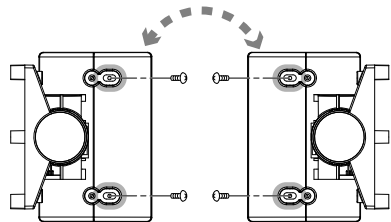

- 4 Pass the wire through the base knockout and install the base on the bracket.

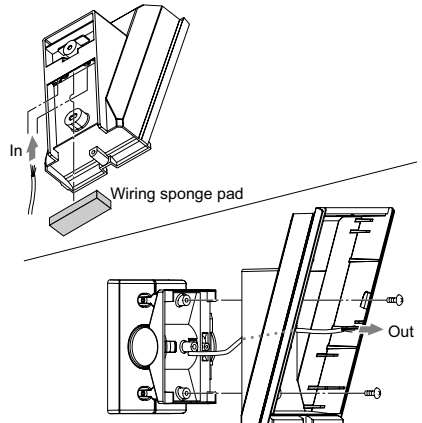

- 5 Tighten the adjustment screw.

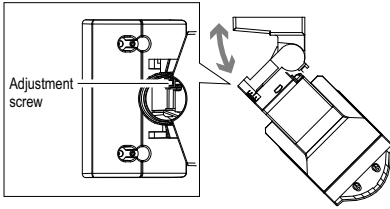

- 6 Wire to the terminal and install the Main unit and lens on the base.

- 7 On the Main unit, make the settings and check operation.

- 8 Using 6-B as reference, adjust the up-down orientation, then tighten the lock screw.

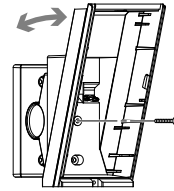

- 9 Fit the shaft cover into place.

Caution>>

Once the operation checks are complete, fit the shaft cover into place. When the Main unit is fastened to the bracket, you can not remove the shaft cover.

6-B Detection distance check and up-down angle adjustment

In cases where the ground is not parallel with the base of the unit the correct detection distance will not be obtained. In such cases, a walk test will be required. To ensure that the required area of detection is achieved.

Complete walk test from outside the walking area to inside. Check that at a distance of 12 to 13m (40 to 43ft.) from the Main unit, the sensor detects the person and the LED lights.

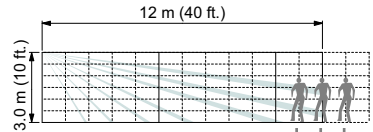

<p>The LED lights when you come closer within 9 m (30 ft.).</p>	<p>The LED lights at 12 m (40 ft.).</p>	<p>The LED lights at a point farther than 13 - 14 m (43 - 47 ft.).</p>
<p>Adjust the angle upward. Carry out the walk test again.</p>	<p>There is no need to adjust the up-down angle.</p>	<p>Adjust the angle downward. Carry out the walk test again.</p>

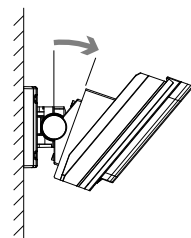
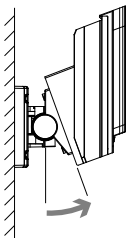

Caution>>

- If the base of the unit is already parallel to the ground,
- Do not change the detection distance by tilting the unit up or down.
- Always use the Masking seals.
- Walk test the unit to ensure that the desired detection distance is achieved.

7 WIRING

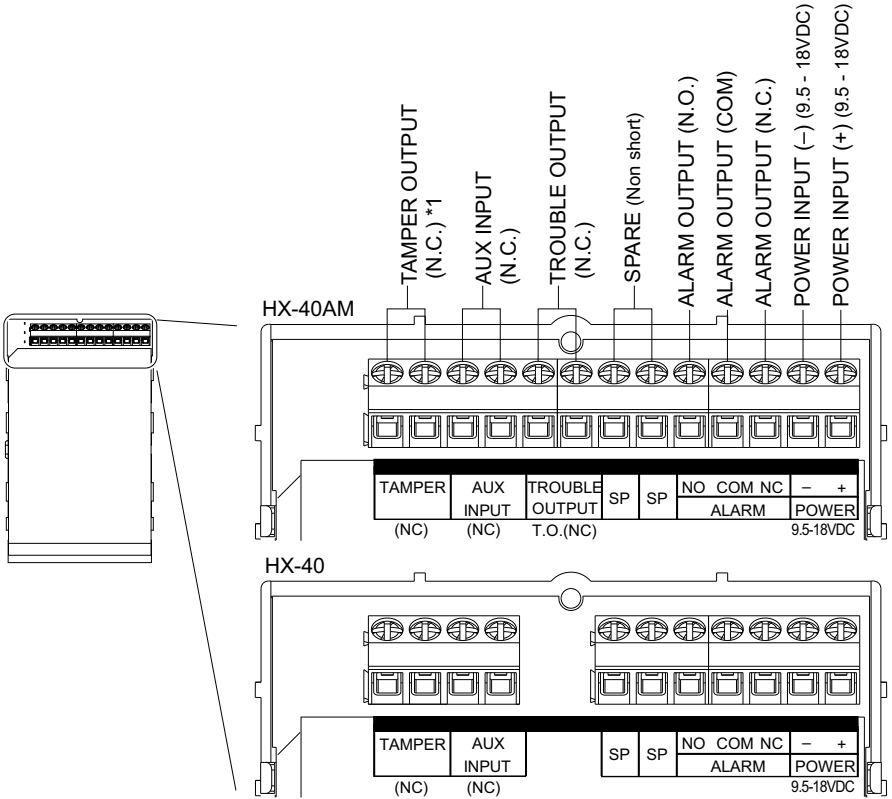

*1: TAMPER terminals to be connected to a 24 hour supervisory loop.

8

FUNCTION SETTING

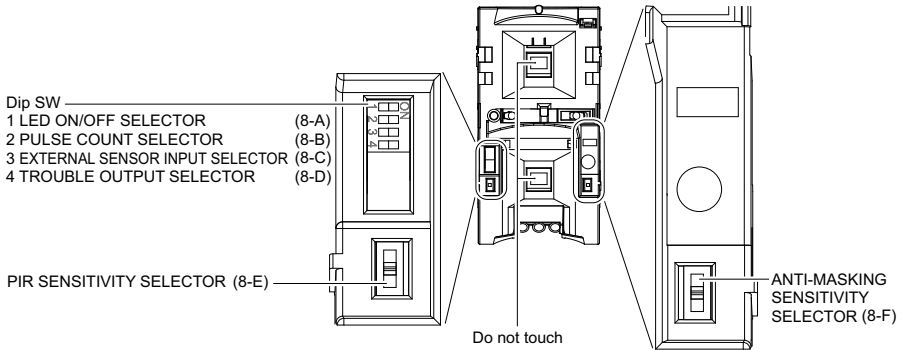

8-A LED ON/OFF

Dip switch 1

HX-40
HX-40AM

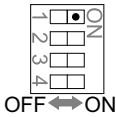

POSITION	FUNCTION
ON (factory default)	The LED lights when someone is detected.
OFF	The LED does not light even if someone is detected.

NOTE: For the walk test, move more than 1 m (0.3 ft.) away from the detector.

8-B PULSE COUNT

Dip switch 2

HX-40
HX-40AM

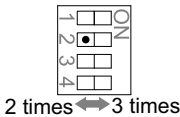

POSITION	FUNCTION
2 times (factory default)	Suitable for standard applications.
3 times	Set this when used in a location with drastic temperature fluctuation or hostile environment .

8-C EXTERNAL SENSOR INPUT

Dip switch 3

HX-40
HX-40AM

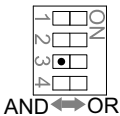

By connecting a satellite unit (another warning sensor), you can expand the detection area and correct false alarms. As a satellite unit, you can use any general no-voltage contact output (NC) warning sensor, including the following. <Infrared (AIR) sensors, thermal line (PIR) sensors, magnet switches, etc.>

POSITION	FUNCTION
AND (factory default)	When both the Main unit and the satellite detect someone, the alarm is output. Set to this when not connecting a satellite unit. Note: The alarm is not output unless both the Main unit and the satellite detect someone within 60 seconds .
OR	When either the Main unit or the satellite detects someone, the alarm is output.

8-D TROUBLE OUTPUT

Dip switch 4

HX-40
HX-40AM

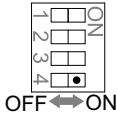

Trouble output is used for anti-masking signal.

When an object is placed close to the lens surface, for a period of more than 180 seconds, the IR Anti-Masking circuit will activate and generate a trouble signal.

POSITION	OUTPUT TERMINAL
ON (factory default)	TROUBLE
OFF	TROUBLE and ALARM Use this when not wiring a dedicated trouble input terminal on the control panel.

LED Operation>>

DETECTOR STATUS	LED Indication	LED operation
Anti-Masking booting (Anti-Masking start up)	Red blinks 2 times and goes off for 5 sec. This movement is repeated.	Red
Anti-Masking	Red blinks 3 times and goes off for 3 sec. This movement is repeated.	Red

8-E PIR SENSITIVITY

PIR SENSITIVITY
SELECTOR

HX-40
HX-40AM

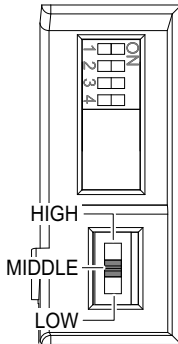

POSITION	FUNCTION
HIGH	Suitable for sites requiring greater sensitivity applications
MIDDLE (factory default)	Suitable for standard applications
LOW	Suitable for hostile and narrow area

8-F ANTI-MASKING

ANTI-MASKING
SENSITIVITY SELECTOR

HX-40
HX-40AM

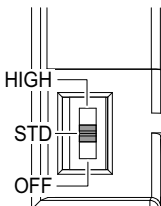

POSITION	FUNCTION
HIGH	Suitable for site requires greater sensitivity applications.
STD (factory default)	Suitable for standard applications.
OFF	Suitable for site requires no anti-masking function.

9-A Example of adjustment for false alarms

If there is a road where people or vehicles can pass in front of the detection area, and can trigger false alarms, adjust the area as follows.

- 1 Delete the unnecessary detection area (a) using the appropriate masking seal(s) 1 2 or 3. (Reduce the distance from 12m, 9m, 5.5m, 4m (40ft., 30ft., 18.3ft., 13.3ft.) as determined by the walk testing.
- 2 Actually move and check that the system does not detect movement on the road (a) but does detect when you enter the detection area (b).

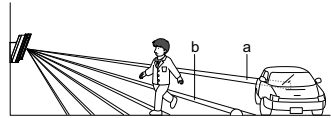
**Caution>>**

The detection area might increase when there is a big temperature difference between the moving object and the background.

For example, when the detection distance is set to 12 m (40 ft.), sometimes vehicles 13 m (43 ft.) away **may be** detected.

In this case, set the detection distance to 9 m (30 ft.). This shortens the alarm area but it can reduce false alarms due to vehicles.

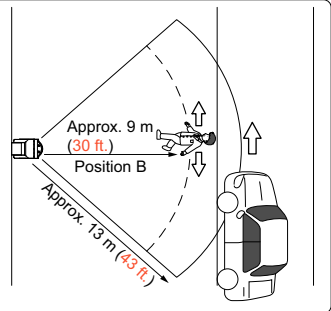
**Caution>>**

A heat source beyond the detection area may cause the detector to cause a false alarm by reflecting off the ground.

Examples of reflective ground is water (puddle), wet road, smooth surface concrete and asphalt road.

The heat source is strong and / or reflection rate is high, detectors detection distance will be longer than required and may detect unwanted objects beyond. According to the ground condition of the installation site, select the detection range position.

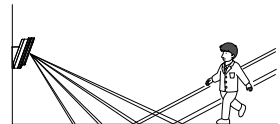

9-B Area Masking

To limit the detection range, apply the area masking seal to the section you want to hide on the lens inside. Configure the area in such a way as to avoid having anything cut across the area.

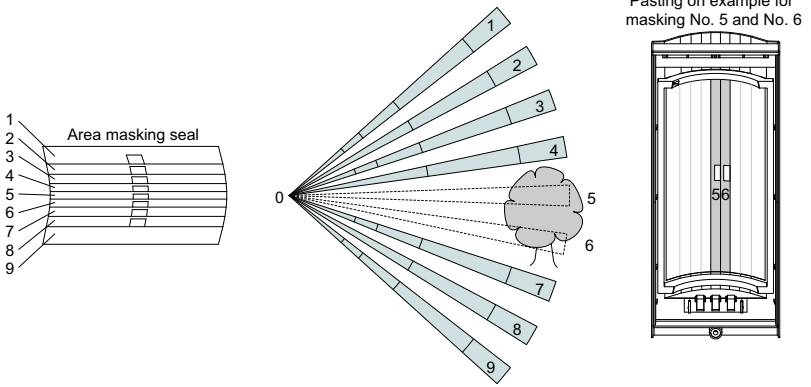

10 LED FUNCTIONS



HX-40

DETECTOR STATUS	LED Indication	LED operation
Alarm	Red light	<input type="checkbox"/> <input checked="" type="checkbox"/> <input type="checkbox"/>
Warm-up period	Red blinks	<input type="checkbox"/> <input checked="" type="checkbox"/> <input type="checkbox"/>

HX-40AM

DETECTOR STATUS	LED Indication	LED operation
Alarm	Red light	<input type="checkbox"/> <input checked="" type="checkbox"/> <input type="checkbox"/>
Warm-up period	Red blinks	<input type="checkbox"/> <input checked="" type="checkbox"/> <input type="checkbox"/>
Trouble output	Anti-Masking booting (Anti-Masking start up)	Red blinks 2 times and goes off for 5 sec. This movement is repeated.
	Anti-Masking	Red blinks 3 times and goes off for 3 sec. This movement is repeated.

11 SPECIFICATIONS

Model	HX-40	HX-40 AM
Detection method	Passive infrared	
PIR Coverage	12 m (40 ft.) 85° wide / 94 zones	
Distance limit	4 m, 5.5 m, 9 m, 12 m (13 ft, 18 ft, 30 ft, 40 ft.)	
Detectable speed	0.3 – 1.5 m/s (1 – 5 ft/s)	
Sensitivity	2.0°C (3.6°F) at 0.6 m/s	
Power input	9.5 – 18VDC	
Current draw	35 mA (max) at 12VDC	40 mA (max) at 12VDC
Alarm period	2.0 ± 1 sec	
Warm-up period	Approx. 60 sec(LED blinks)	
Alarm output	Form C 28VDC 0.2A max	
Tamper output	N.C. 28V DC, 0.1A max	
Trouble output	–	N.C. 28V DC, 0.1A max
Aux input	N.C. 28V DC, 0.1A max	
LED indicator	Red:Warm-up, Alarm	Red:Warm-up, Alarm, Trouble
RF Interference	No alarm 10 V/m	
Operating temperature	-20 – +60°C (-4 – +140°F)	
Environment humidity	95% max	
Weatherproof	IP55	
Mounting	Wall (Outdoor, Indoor)	
Mounting height	2.5 - 3.0 m (8.3 - 10 ft.)	
Bracket adjust angle	Vertical: ± 20° Horizon: ± 95°	
Weight	600 g (21.2 oz)	
Accessories	Bracket, Hood, Area masking seal, Screw kit (3×10-2, 4×20-4)	

* Specifications and design are subject to change without prior notice.

DIMENSIONS

Using bracket and hood

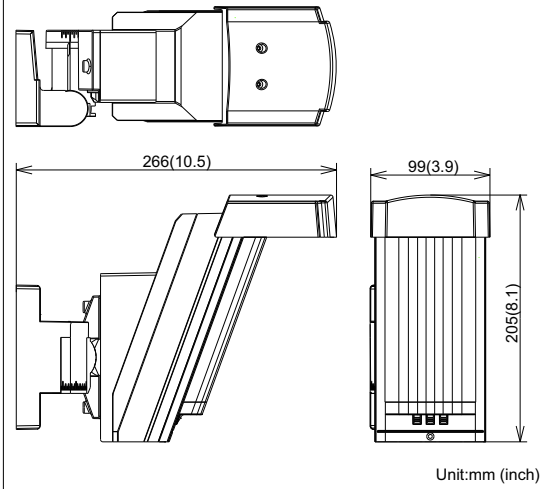

Without bracket and hood

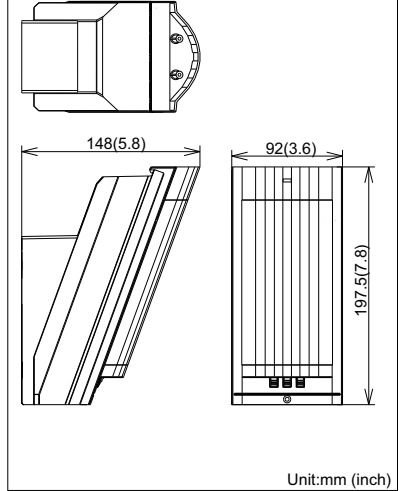

WARRANTY

5 year replacement warranty

The HX-40 series is designed to detect movement of an intruder and activate an alarm control panel.

Being only a part of a complete system, we cannot accept complete responsibility for any damages or other consequences resulting from an intrusion. Due to our policy of continuous improvement Optex reserves the right to change specification without prior notice.

The Warranty period is from the date of purchase.



OPTEX CO., LTD. (JAPAN)

(ISO 9001 Certified by LRQA) (ISO 14001 Certified by JET)

5-8-12 Ogoto Otsu Shiga 520-0101 JAPAN

TEL:+81-77-579-8670 FAX:+81-77-579-8190 URL:<http://www.optex.co.jp/e/>

OPTEX INCORPORATED (USA)

TEL:+1-909-993-5770

Tech:(800)966-7839

URL:<http://www.optexamerica.com>

OPTEX (EUROPE) LTD. (UK)

TEL:+44-1628-631000

URL:<http://www.optex-europe.com>

OPTEX SECURITY SAS (FRANCE)

TEL:+33-437-55-50-50

URL:<http://www.optex-security.com>

OPTEX SECURITY Sp.z o.o. (POLAND)

TEL:+48-22-598-06-55

URL:<http://www.optex.com.pl>

OPTEX KOREA CO., LTD. (KOREA)

TEL:+82-2-719-5971

URL:<http://www.optexkorea.com>

OPTEX (DONGGUAN) CO., LTD. SHENZHEN OFFICE (CHINA)

TEL:+86-755-33302950

URL:<http://www.optexchina.com>